



organizer/listino 2024

Architectural design

**FLORIM**



“Guardiamo al business come una forza positiva in grado di generare profitto e allo stesso tempo creare un impatto virtuoso sulle persone e sull’ambiente. Da sempre.

Le nostre scelte, giorno dopo giorno, ci hanno portato a migliorare il nostro modo di fare impresa.”

*“We conceive the business as a positive force able to generate profits and at the same time create a virtuous impact on people and the environment. Since forever.*

*Our choices, day after day, have led us to improve our way of doing business.”*

Ci siamo misurati con **alti standard di performance sociale e ambientale** e dopo un lungo e rigoroso processo di verifica **siamo diventati B Corp.**

*We vied with **high social and environmental performance standards**, and after a long and scrupulous verification process, we became a B Corp certified company.*

Le B Corp costituiscono un movimento globale di ‘Purpose Driven Businesses’ che ha l’obiettivo di diffondere un **nuovo paradigma economico**, che vede le imprese come protagoniste nella diffusione di modelli di business per un’economia più equa e inclusiva.

*B Corps constitute a global movement of ‘Purpose Driven Businesses’ with the goal of spreading a **new economic paradigm**, where companies play a leading role in promoting business models for a fairer and more inclusive economy.*



**Scopri di più:**  
*Find out more:*



Siamo orgogliosi di far parte di un **cambiamento culturale epocale** e rientrare tra il 3% delle imprese che sono riuscite a raggiungere la certificazione.

*We are proud to be part of an **epochal cultural change** and to belong to the 3% of companies that have successfully achieved certification.*

Il nostro risultato non è altro che la conseguenza di molteplici attività compiute negli anni passati: dal 2008 redigiamo il **Bilancio di Sostenibilità** e il 19 marzo 2020 siamo diventati **Società Benefit**, formalizzando il nostro impegno a migliorare l’impatto positivo sulla società e sull’ambiente.

*Our result is nothing more than the consequence of multiple activities carried out in past years: since 2008, we have prepared the **Sustainability Report**, and on March 19, 2020, we became a **Benefit Corporation**, formalizing our commitment to improving our positive impact on society and the environment.*





Sono le superfici  
Carbon Neutral di Florim  
che **compensano tutta la CO<sub>2</sub>**  
emessa durante il loro ciclo di vita.

*Florim's Carbon Neutral surfaces  
**offset all the CO<sub>2</sub>** emitted during  
their lifecycle.*



**Misuriamo** l'impatto ambientale delle nostre superfici, dalle materie prime allo smaltimento.

*We measure the environmental impact of our surfaces, from raw materials to disposal.*

**Riduciamo** l'uso di risorse naturali e abbattiamo le nostre emissioni grazie a un processo produttivo più sostenibile: fino al 100% in termini di acqua, energia elettrica e recupero degli scarti crudi.

*We reduce the use of natural resources and lower our emissions through a manufacturing process that is more sustainable: up to 100% in terms of water, electricity, and raw waste recovery.*

**Compensiamo** tutta la CO<sub>2</sub> emessa durante il ciclo di vita, creando collezioni Carbon Neutral.

*We offset all the CO<sub>2</sub> emitted during the lifecycle creating Carbon Neutral collections.*



Scopri di più:  
*Find out more:*



# Azienda

Produciamo superfici ceramiche da oltre 60 anni con **passione, innovazione, impegno costante al miglioramento e responsabilità sociale** d'impresa. Sono queste le linee guida che contraddistinguono il nostro modo di fare impresa: il **MADE IN FLORIM**.

We produce porcelain stoneware surfaces with **passion, innovation and in a socially responsible way**. Those are the guidelines that identify our business and which can be summed up in a few words: **MADE IN FLORIM**.

Nous produisons des surfaces céramiques depuis plus de 60 ans avec **passion, innovation, recherche et une attention à la responsabilité sociale d'entreprise**. Ce sont les lignes phares qui guident notre mode de travailler: le **MADE IN FLORIM**.

Wir produzieren seit über 60 Jahren Keramikoberflächen mit **Leidenschaft, Innovationsgeist, ständigem Engagement für Verbesserungen und sozialer Unternehmensverantwortung**. Dies sind die Prinzipien, die unsere Arbeitsweise auszeichnen: kurz **MADE IN FLORIM**.

Producimos superficies cerámicas por más de 60 años con **pasión, innovación, compromiso de mejora constante y responsabilidad social**. Estos son los valores distintivos de nuestro modo de hacer empresa: el **MADE IN FLORIM**.





---

# Architectural design

Materiale tecnico seguendo le tendenze dell'architettura, per applicazioni quali pavimentazioni industriali e realizzazioni pubbliche a medio e ad alto traffico, come aeroporti, centri commerciali, ristoranti, uffici, negozi, ma anche applicazioni residenziali con un mirato contenuto estetico.

Technical material in line with architectural trends, for applications such as industrial flooring and public buildings with medium to high footfall, such as airports, shopping centres, restaurants, offices, shops, as well as residential applications featuring a targeted aesthetic content.

Matériau technique suivant les tendances de l'architecture, pour des applications en tant que sols industriels et des réalisations publiques à trafic moyen et intense, comme les aéroports, les centres commerciaux, les restaurants, les bureaux, les magasins, mais aussi pour des applications résidentielles au contenu esthétique ciblé.

Technisches Material im Einklang mit den architektonischen Trends für Anwendungen wie Industrieböden und mittelhoch bis stark frequentierte öffentliche Bereiche wie Flughäfen, Einkaufszentren, Restaurants, Büros und Läden, aber auch für Wohngebäude mit wertiger Optik.

Material técnico que sigue las tendencias de la arquitectura, creado para pavimentos industriales y ambientes públicos de mediano y alto tránsito —como aeropuertos, centros comerciales, restaurantes, oficinas y tiendas—, pero también para aplicaciones residenciales con un refinado contenido estético.

## performance



## appeal



## project



## ecobuilding

---

# Indice





## **gres fine porcellanato**

fine porcelain stoneware / grès cérame fin  
feinsteinzeug-kollektionen / gres porcelánico fino

<b>14/25</b>	Airtech
<b>26/37</b>	Biotech
<b>38/49</b>	B&W_Marble
<b>50/71</b>	Buildtech/2.0
<b>72/81</b>	Coretech
<b>82/105</b>	Earthtech
<b>106/113</b>	Floortech/1.0
<b>114/121</b>	Flowtech
<b>122/135</b>	Industrial
<b>136/151</b>	Plimatech
<b>152/161</b>	Rawtech
<b>162/173</b>	Stontech/4.0
<b>174/183</b>	Walks/1.0

## **gres porcellanato decorato**

decorated porcelain tiles  
grès cérame décoré  
verziertes feinsteinzeug  
gres porcelánico decorado

<b>66/71</b>		Buildtech/2.0
--------------	--	---------------



---

# La simbologia

SYMBOL/SYMBOLS/SYMBOL/SIMBOLOGIA

**DIN 16165 ANNEX B:** Scivolosità a piedi calzati: il materiale ceramico viene posto su un piano e oliato. Successivamente il piano viene progressivamente inclinato, mentre un operatore con scarpa di gomma cammina lungo il piano fino a quando non inizia a scivolare; la misura dell'angolo che si forma tra il piano inclinato e il suolo all'inizio dello scivolamento determina la classificazione del materiale. / Shod foot slipperiness: the ceramic material is placed on a surface and oiled. Subsequently, the surface is progressively tilted, while an operator with rubber shoes walks along the surface until he starts to slip; the measurement of the angle that is formed between the inclined surface and the ground when the slipping starts determines the classification of the material. / Glissance pieds chaussés : le matériau céramique est mis sur un plan et huilé. Le plan est ensuite incliné progressivement, tandis qu'un opérateur avec des chaussures en caoutchouc marche le long du plan jusqu'à ce qu'il ne commence à glisser ; la mesure de l'angle qui se forme entre le plan incliné et le sol au début du glissement donne la classification du matériau. / Rutschsicherheit auf Schuhen: Das Keramikmaterial wird auf einer Fläche angebracht und mit einem Gleitmittel bestrichen. Daraufhin wird die Fläche nach und nach geneigt, während eine Prüfperson mit Gummischuhen die Fläche entlangläuft, bis sie ins Rutschen gerät. Die Größe des Winkels, der zwischen der geneigten Fläche und dem Boden zu Beginn der Rutschbewegung entsteht, bestimmt die Klassifizierung des Materials. / Deslizamiento con pies descalzos: el material cerámico se coloca sobre un plano y se aceita. Seguidamente el plano se inclina progresivamente, mientras que un operador con calzado de goma camina a lo largo del plano hasta que empieza a resbalar; la medida del ángulo que se forma entre la superficie inclinada y el suelo al principio del deslizamiento determina la clasificación del material.

**DIN 16165 ANNEX A:** Scivolosità a piedi nudi: il materiale ceramico viene posto su un piano e bagnato. Successivamente il piano viene progressivamente inclinato, mentre un operatore con piede nudo cammina lungo il piano fino a quando non inizia a scivolare; la misura dell'angolo che si forma tra il piano inclinato e il suolo all'inizio dello scivolamento determina la classificazione del materiale. / Barefoot slipperiness: the ceramic material is placed on a surface and made wet. Subsequently, the surface is progressively tilted, while an operator with bare feet walks along the surface until he starts to slip; the measurement of the angle that is formed between the inclined plane and the ground when slipping starts determines the classification of the material. / Glissance pieds nus : le matériau céramique est mis sur un plan et mouillé. Le plan est ensuite incliné progressivement, tandis qu'un opérateur pieds nus marche le long du plan jusqu'à ce qu'il ne commence à glisser ; la mesure de l'angle qui se forme entre le plan incliné et le sol au début du glissement donne la classification du matériau. / Rutschsicherheit barfuß: Das Keramikmaterial wird auf einer Fläche angebracht und befeuchtet. Daraufhin wird die Fläche nach und nach geneigt, während eine Prüfperson barfuß die Fläche entlangläuft, bis sie ins Rutschen gerät. Die Größe des Winkels, der zwischen der geneigten Fläche und dem Boden zu Beginn der Rutschbewegung entsteht, bestimmt die Klassifizierung des Materials. / Deslizamiento con pies descalzos: el material cerámico se pone sobre un plano y se moja. Seguidamente el plano se inclina progresivamente, mientras que un operador con los pies descalzos camina a lo largo del plano hasta que empieza a resbalar; la medida del ángulo que se forma entre la superficie inclinada y el suelo al principio del deslizamiento determina la clasificación del material.

**DCOF:** Coefficiente di attrito dinamico: viene misurata la forza necessaria per mantenere in movimento un elemento (BOT 3000) rivestito in gomma dalla superficie della piastrella in condizioni di superficie bagnata; il rapporto tra la forza necessaria e il peso dell'elemento scivolante indica il Coefficiente di attrito dinamico. / Dynamic coefficient of friction: the force required to maintain the movement of an element (BOT 3000) coated with rubber on the surface of the tile in wet surface conditions is measured; the relationship between the force required and the weight of the slipping element indicates the dynamic coefficient of friction. / Coefficient de frottement dynamique : la force nécessaire pour maintenir en mouvement un élément (BOT 3000) revêtu en caoutchouc sur la surface du carreau en conditions de surface mouillée est mesurée ; la relation entre la force nécessaire et le poids de l'élément glissant indique le coefficient de frottement dynamique. / Dynamischer Reibungskoeffizient: Gemessen wird die Kraft, die erforderlich ist, um ein Element mit Gummiverkleidung (BOT 3000) durch die Fliese bei nasser Oberfläche in Bewegung zu halten. Das Verhältnis zwischen der erforderlichen Kraft und dem Gewicht des gleitenden Elements gibt den dynamischen Reibungskoeffizienten wieder. / Coeficiente de fricción cinética: se mide la fuerza necesaria para mantener en movimiento un elemento (BOT 3000) revestido de goma por la superficie de la baldosa bajo condiciones de superficie mojada; la relación entre la fuerza necesaria y el peso del elemento que resbala indica el Coeficiente de fricción dinámica.

---

## SQUADRATO / SQUARED / EQUARRI / REKTIFIZIERT / ESCUADRADO

Piastrelle o lastre ceramiche portate a dimensioni predefinite, ognuno esattamente uguale all'altra (monocalibro) con sistema di mole abrasive. Ceramic tiles or slabs made to a pre-defined size, each one exactly the same as the others (single size), using a system of abrasive grinders. / Carreaux ou dalles céramiques mises aux dimensions prédéfinies, parfaitement identiques l'une à l'autre (mono-calibre) grâce à un système de disques abrasifs. / Fliesen oder Keramikplatten mit festgelegten Formaten. Alle Fliesen sind aufgrund der Verwendung des Schleifscheiben-Systems hundertprozentig identisch (Monokaliber). / Baldosas o piezas de cerámica que se realizan con dimensiones predefinidas, cada pieza es exactamente igual a la otra (mono dimensión) con sistema de discos abrasivos.

# Grado di variazione cromatica

DEGREE OF COLOUR CHANGE/DEGRE DE VARIATION CHROMATIQUE/GRAD DER FARBABWEICHUNG/GRADO DE VARIACIÓN CROMÁTICA

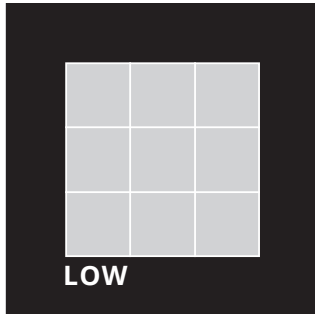

## v1

### PRODOTTO MONOCROMATICO.

The least amount of shade and texture variation.

Attainable in naturally fired clay products.

Produit monochromatique.

Eifarbiges produkt.

Producto monocromático.



## v2

### PRODOTTO CON LEGGERA VARIAZIONE CROMATICA.

Light to moderate shade and texture variation within each carton.

Produit à légère variation chromatique.

Produkt mit leichter farbnuance.

Producto con una pequeña variación cromática.



## v3

### PRODOTTO CON MARCATA VARIAZIONE CROMATICA.

High shade texture variation within each carton.

Produit à variation chromatique accentuée.

Produkt mit ausgeprägter farbnuance.

Producto con evidente variación cromática.



## v4

### PRODOTTO CON FORTE VARIAZIONE CROMATICA.

Very high shade and texture variation within each carton.

Produit à forte variation chromatique.

Produkt mit starker farbnuance.

Producto con fuerte variación cromática.



---

# Superfici

SURFACES/SURFACES/OBERFLÄCHEN/SUPERFICIES

## **Naturale** / Matte / Mat / Matt / Mate

Superficie risultante dalla produzione di piastrella pressata senza lavorazioni successive alla cottura. / Surface coming from manufacturing pressed tiles without further work after firing. / Surface résultant de la production d'un carreau pressé sans être travaillé après la cuisson. / Die Oberfläche entsteht durch das Fliesenpressverfahren - im Anschluss an das Brennen erfolgt keine weitere Bearbeitung. / Superficie que resulta de la producción de baldosa prensada sin ulteriores elaboraciones después de la cocción.

## **Strutturato** / Structured / Structuré / Strukturiert / Estructurado

Superficie risultante dalla produzione di piastrella pressata, a tampono non liscio con intensità di evidenza variabile (da leggera ondulazione ad imitazione di pietra tagliata), senza lavorazioni successive alla cottura. / Surface coming from manufacturing pressed tiles, using a rough pad with variable intensity (from a slightly undulating one to inspired cut stone), without processing after firing. / Surface obtenue à partir de la production d'un carreau pressé, par un tampon à relief avec une intensité d'aspect variable (de légère ondulation à l'inspiration de la pierre taillée), sans être travaillé après la cuisson. / Die Oberfläche beruht auf dem Produktionsverfahren der Fliesenpressung unter Verwendung eines unglatten Stempels mit Intensitätsvariation (leichte Wellung entsprechend eines geschnittenen Steins). Es erfolgt keine Weiterbearbeitung nach dem Brennen. / Superficie que resulta de la producción de baldosa prensada, con tampono no liso con intensidad de evidencia variable (de ligera ondulación a imitación de piedra cortada), sin ulteriores elaboraciones después de la cocción.

## **Bocciardato** / Bush-hammered / Bouchardé / Gehämmert / Abujardado

Superficie risultante dalla produzione di piastrella sottoposta, dopo la pressatura ma prima della cottura, a lavorazione meccanica consistente nell'asportazione irregolare di uno strato di materia per ottenere una superficie come per la pietra assolutamente naturale (antiscivolo), con leggere differenze non ripetibili tra una piastrella ed un'altra. / Surface coming from manufacturing tiles subjected to mechanical processing consisting of irregularly removing a layer of material after pressing but before firing in order to obtain a surface like absolutely pure natural stone (non slip), with slight unrepeatable differences between one tile and another. / Surface obtenue à partir de la production d'un carreau soumis, après le pressage mais avant la cuisson, à un travail mécanique qui consiste à éliminer de façon irrégulière une épaisseur de matière afin d'obtenir une surface semblable à la pierre naturelle tout à fait naturelle (anti-glisse), avec de légères différences variant d'un carreau à l'autre. / Zur Gewinnung dieser Oberfläche wurde die Fliese im Anschluss an die Pressung und vor dem Brennen einer mechanischen Bearbeitung zur Abtragung von Unregelmäßigkeiten einer Materialschicht unterzogen. Mit Hilfe dieses Verfahrens wird eine absolut natürliche und dem Naturstein entsprechende (rutschfeste) Oberfläche erzielt, die für geringfügige, aber einmalige Unterschiede unter den Fliesen verantwortlich ist. / Superficie que resulta de la producción de baldosa sometida, después del prensado pero antes de la cocción, a un proceso mecánico consistente en la eliminación irregular de una capa de materia para obtener una superficie como la piedra totalmente natural (resistente al deslizamiento), con ligeras diferencias que no se repiten entre una baldosa y otra.

## **High - Glossy**

Finitura ottenuta sottoponendo la superficie non smaltata a lucidatura meccanica di media intensità dopo la cottura; la superficie finale è morbida, lucida e riflettente. / Finish obtained by subjecting the unglazed surface to medium intensity mechanical polishing after firing. The final surface is soft, glossy and reflective. / Finition obtenue en soumettant la surface non émaillée à un polissage mécanique d'intensité moyenne après cuisson; la surface finale est douce, brillante et réfléchissante. / Um das Finish zu erzielen, wird die unglasierte Oberfläche nach dem Brand einer mechanischen Politur von mittlerer Stärke unterzogen; die Oberfläche ist anschließend weich, poliert und reflektierend. / Acabado que se obtiene sometiendo la superficie no esmaltada al pulido mecánico de mediana intensidad tras la cocción; la superficie final es lisa, pulida y reflectante.

## **Superficie R+PTV** / R+PTV Surface / Surface R+PTV / Oberfläche R+PTV / Superficie R+PTV

Superficie ottenuta dalla produzione di piastrella con tampono opportunamente sagomato così da raggiungere precise caratteristiche di sicurezza misurate secondo i principali metodi normativi in uso. La superficie finale è leggermente ruvida, opaca e conforme ai requisiti di scivolosità R10 (norma di riferimento DIN EN 16165 ANNEX B) e scivolosità Pendolo >36 wet (slider 96, norma di riferimento BS EN 16165 ANNEX C -AS/NZS 4586). Surface obtained from the production of tiles with appropriately shaped die in order to achieve precise safety characteristics measured based on the main prevailing regulatory methods in use. The final surface is slightly rough, matt and complies with R10 slipperiness requirements (reference standard DIN EN 16165 ANNEX B) and Pendulum slipperiness >36 wet (slider 96, reference standard BS EN 16165 ANNEX C -AS/NZS 4586). Surface obtenue à partir de la production de carreaux avec tampon opportunément façonné de manière à satisfaire des caractéristiques de sécurité précises, mesurées suivant les principales méthodes réglementaires en vigueur. La surface finale est légèrement rugueuse, mate et répond aux exigences de la classe de glissance R10 (norme de référence EN 16165 ANNEX B) et de glissance - test du pendule - humide - valeur >36 (slider 96, norme de référence BS EN 16165 ANNEX C -AS/NZS 4586). / Durch die Produktion von Fliesen mit entsprechend geformter Kachelunterlage erhaltene Oberfläche, um präzise Sicherheits-Charakteristiken zu erzielen, gemessen nach den wichtigsten angewandten Regelungsmethoden. Die fertige Oberfläche ist leicht angeraut, matt und konform mit den rutschhemmenden Eigenschaft R10 (Bezugsnorm EN 16165 ANNEX B) und der Rutschfestigkeit Pendolo >36 wet (slider 96, Bezugsnorm BS EN 16165 ANNEX C -AS/NZS 4586). / Superficie obtenida de la producción de baldosas con un molde específicamente fabricado para alcanzar características precisas de seguridad de conformidad con los principales métodos normativos vigentes. La superficie final es ligeramente áspera, opaca y conforme a los requisitos de resistencia al deslizamiento R10 (norma de referencia EN 16165 ANNEX B) y resistencia al deslizamiento Péndulo >36 mojado (slider 96, norma de referencia BS EN 16165 ANNEX C -AS/NZS 4586).

## Comfort

La nuova superficie Comfort è frutto dello storico know-how industriale della nostra azienda e rappresenta una vera e propria rivoluzione nell'utilizzo del prodotto ceramico. Comfort unisce il tatto morbido e piacevole delle finiture naturali con prestazioni tecniche sulla scivolosità (R10 classe B e PTV>36) che la rendono particolarmente indicata nelle applicazioni pubbliche e commerciali, anche in condizioni di umidità e bagnato. / The new Comfort surface is the outcome of our company's historic industrial know-how and represents a real revolution in the use of ceramic products. Comfort combines the soft, pleasant feel of a matte surface with anti-slip technical performances (R10 class B and PTV >36) that make it particularly suitable for public and commercial applications, including in wet and humid conditions. / La nouvelle surface Comfort est l'aboutissement d'un savoir-faire industriel historique de notre entreprise. Elle révolutionne l'utilisation du produit céramique. Comfort allie le toucher doux et agréable des finitions naturelles aux performances techniques sur la glissance (R10 classe B et PTV >36). La surface est ainsi tout particulièrement indiquée dans les applications publiques et commerciales, y compris dans les lieux humides et mouillés. / Die neue Oberfläche Comfort basiert auf dem langjährigen produktionstechnischen Know-how unseres Unternehmens und steht für eine echte Revolution in der Verwendung keramischer Produkte. Comfort vereint die angenehm weiche Haptik einer natürlichen Oberfläche mit technischen Eigenschaften in punkto Rutschhemmung (R10 Klasse B und PTV>36), die das Produkt für den Einsatz in öffentlichen und gewerblichen Bereichen, und zwar auch bei Feuchtigkeit und Nässe, prädestinieren. La nueva superficie Comfort es fruto del histórico saber hacer industrial de nuestra empresa y representa una auténtica revolución en el uso del producto cerámico. Comfort aún el tacto suave y agradable del acabado natural con unas prestaciones técnicas de resistencia al deslizamiento (R10 clase B y PTV>36) que la convierten en particularmente indicada para aplicaciones públicas y comerciales, incluso en condiciones de humedad y de mojado.

## Cannetè / Cannetè / Cannetè / Cannetè / Cannetè

Superficie risultante dalla produzione di piastrella pressata a tampone non liscio con rilievi geometrici regolari ad intensità crescente, senza lavorazioni successive alla cottura. / Surface resulting from the manufacturing of a tile pressed with a non-smooth pad featuring regular geometrical embossing with increasing intensity, with no further processing after firing. / Surface obtenue à partir de la production d'un carreau pressé à l'aide d'un tampon non lisse avec des reliefs géométriques d'intensité croissante, sans usinage après la cuisson. / Die Oberflächen sind das Ergebnis des Produktionsverfahrens der Fliesenpressung unter Verwendung eines unglatten Stempels mit gleichmäßigen geometrischen Reliefs ohne eine Weiterbearbeitung nach dem Brennen. / Superficie resultante de la producción de azulejos prensados con tampones texturados, con relieves geométricos regulares de intensidad creciente, sin elaboraciones posteriores a la cocción.

## Soft / Soft / Soft / Soft / Soft - Lucido / Shiny / Brillant / Glänzend / Brillante

Superficie risultante dalla produzione di piastrella pressata, sottoposta a lavorazione meccanica di intensità intermedia, successiva alla cottura per dare alla superficie una finitura morbida e lievemente satinata, levigata ma non riflettente. / Surface coming from manufacturing pressed tiles, with a smooth or structured pad, subjected to intermediate intensity mechanical processing, with little removal of the material after firing to give the surface a smooth and slightly glazed finish, polished but not reflecting. / Surface obtenue à partir de la production d'un carreau pressé, par un tampon lisse ou structuré, soumis à un travail mécanique d'une intensité moyenne, avec une élimination minimale de matière après la cuisson, afin de donner à la surface une finition douce et légèrement satinée, polie mais non réfléchissante. / Die Oberfläche entsteht durch eine Fliesenpressung unter Verwendung eines glatten oder strukturierten Stempels. Die Fliese wird einer mittelschweren mechanischen Bearbeitung unterzogen, wobei im Anschluss an das Brennen eine minimale Materialmenge abgetragen wurde. Dies verleiht der Oberfläche ein weiches, leicht satiniertes, geschliffenes aber reflektionsfreies Finish. / Superficie que resulta de la producción de baldosa prensada, con tampón liso o estructurado, sometido a un proceso mecánico de intensidad intermedia, con mínima eliminación de materia, posterior a la cocción para dar a la superficie un acabado suave y levemente satinado, pulido pero no reflectante.

## Glossy-bright

Glossy - Bright è l'innovativa superficie lucida di Florim che valorizza il materiale full body di cui la lastra è composta. Questa finitura conferisce un'elevata profondità estetica ricordando l'effetto tipico dei prodotti levigati e garantendo performance tecniche ad essi assimilabili. Glossy - Bright, infatti, unisce brillantezza ed eccellenti caratteristiche di resistenza all'usura, raramente riscontrabili in un materiale dall'effetto lucido. / Glossy - Bright is Florim's innovative shiny surface that enhances the full body material used to make the slab. This surface has an effect of particular depth, evoking the typical appearance of polished products and delivering technical performances very similar to these. In fact, Glossy - Bright combines brilliance and excellent wear resistance, qualities rarely found in a material with a glossy effect. / Glossy - Bright est l'incroyable surface brillante de Florim qui met en valeur le matériau pleine masse de la dalle. Cette finition donne plus de profondeur esthétique et évoque l'effet typique des produits polis, tout en garantissant des performances techniques similaires. Glossy - Bright allie, en effet, brillance et excellente résistance à l'usure, ce que l'on trouve rarement dans un matériau effet shiny. / Glossy - Bright, die innovative glänzende Oberfläche von Florim, die dem Plattenmaterial eine wertige Ausstrahlung verleiht. Die Beschaffenheit der Oberfläche schafft mehr Tiefe und erinnert an den typischen Effekt polierter Produkte und bietet gleichzeitig eine mit diesen Produkten vergleichbare technische Performance. Glossy - Bright verbindet in der Tat Brillanz mit hoher Verschleißfestigkeit, die in einem Material mit Glanzoptik selten zu finden ist. / Glossy - Bright es la innovadora superficie brillante de Florim que valoriza la propia materia con la que está hecha la placa. Este acabado confiere una elevada profundidad estética remitiendo al efecto típico de los productos pulidos y garantizando unas prestaciones técnicas asimilables a los mismos. Glossy - Bright, en efecto, aún brillo y unas excelentes características de resistencia al desgaste, propiedades insólitas en un material de aspecto brillante.

---

# Tabella Imballi

PACKAGE TABLE - TABLEAU DE EMBALLAGES - TABELLE FORMATE - TABLA DE LOS EMBALAJES

	scatola - box			pallet		
	pz	mq	kg	box	mq	kg





**imballi per scatola**  
packages for boxes  
emballages pour boîte  
verpackungen für schachteln  
embalajes para cajas

**imballi per pallet**  
packages for pallets  
emballages pour palette  
verpackungen für paletts  
embalajes para paletas



# Tabella gruppi di prezzo

TABLE OF PRICE RANGES - TABLEAU GROUPE DES PRIX - TABELLE PREISGRUPPEN - TABLA DE GRUPO DE PRECIOS

Descrizione simboli / Description of symbols / Description symboles / Zeichenerklärung / Descripción de los símbolos			
			
<p><b>PREZZO PER MATERIALE GESTITO A METRO QUADRO</b></p> <p>Price for materials managed per square metre.                      Prix pour matériau géré au mètre carré                      Materialpreis pro Quadratmeter                      Precio del material por metro cuadrado</p>	<p><b>*PREZZO PER MATERIALE GESTITO A PEZZO</b></p> <p>Price for materials managed per piece                      Prix pour matériau géré à la pièce                      Materialpreis pro Stück                      Precio del material por pieza</p>	<p><b>PREZZO PER MATERIALE GESTITO A NUMERO/COMPOSIZIONE</b></p> <p>Price for materials managed per number/composition                      Prix pour matériau géré à nombre/composition                      Materialpreis pro Anzahl/zusammenstellung                      Precio del material por número/composición</p>	<p><b>PREZZO PER MATERIALE GESTITO A METRO LINEARE</b></p> <p>Price for materials managed lm                      Prix pour matériau géré à mètre linéaire                      Materialpreis pro Lfm                      Precio del material por ml</p>
<p><b>*costo al pezzo, vendita a scatola completa</b>                      price per piece, sold by full boxes only • prix à la pièce, vente à la boîte complète • stückpreis bei voller kartenabnahme • precio à la pieza, venta à caja completata</p>			



# AIRTECH

gres fine porcellanato  
fine porcelain stoneware  
grès cérame fin  
feinsteinzeug-kollektionen  
gres porcelánico fino

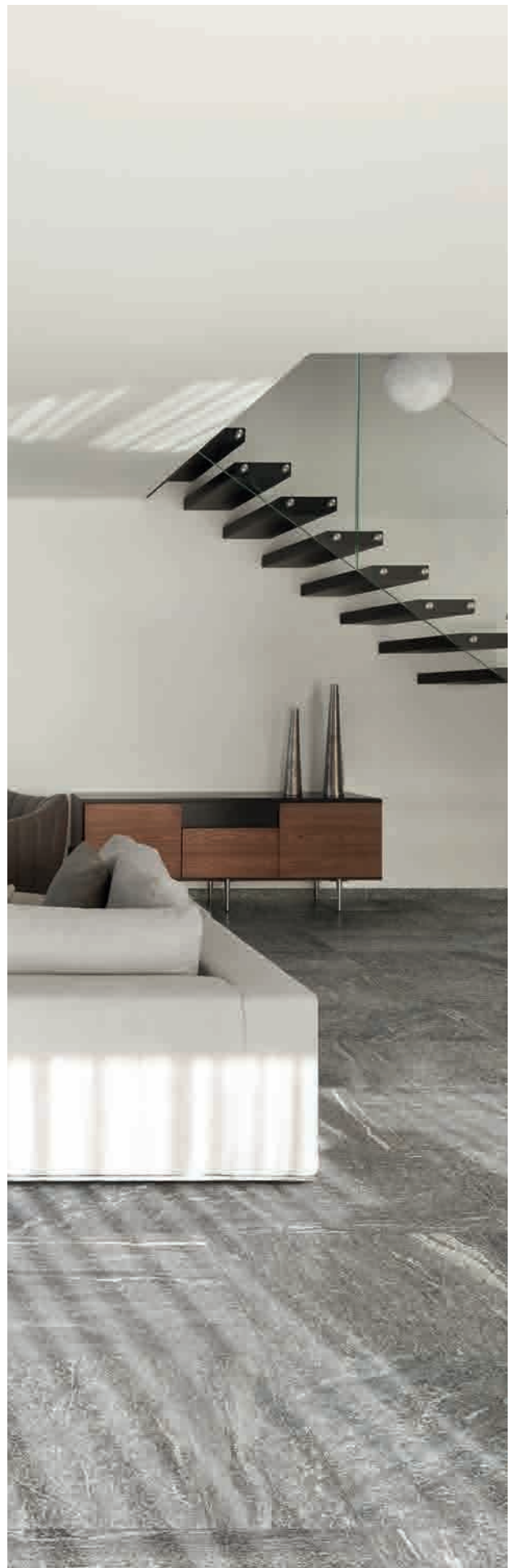



## AIRTECH

La continua evoluzione architettonica e i nuovi stili di vita sono sempre più orientati alla ricerca di ambienti osmotici in cui il dentro sconfini nel fuori con una informalità naturale. Per questo diventa necessario trovare una superficie fluida adatta alla creazione di luoghi che dialoghino tra loro in modo uniforme e discreto. **Airtech** è stata pensata per integrarsi in tutti gli spazi in cui il proprio istinto progettuale possa lasciare un segno distintivo. Un sistema completo di superfici, colori e formati definiscono potenzialità inattese.

The constant evolution of architecture and our new lifestyles have led more and more towards the search for osmotic environments where the inside encroaches on the outside spaces with a natural informality. This is why it becomes necessary to find a fluid surface suitable for creating places that will dialogue with each other uniformly and discreetly. **Airtech** has been devised to integrate into all spaces in which one's instinct for design can leave a distinctive mark. A complete system of surface finishes, colours and sizes highlight unexpected potentialities.

L'évolution architecturale constante et les nouveaux styles de vie sont de plus en plus orientés vers la recherche d'espaces osmotiques où l'intérieur empiète sur l'extérieur avec une informalité naturelle. Il devient ainsi nécessaire de trouver une surface fluide adaptée à la création de lieux en mesure de dialoguer entre eux de façon uniforme et discrète. La série **Airtech** a été conçue pour s'adapter à tous les espaces pouvant se distinguer par l'instinct de l'architecte. Un système complet de surfaces, de couleurs et de formats qui définissent des potentialités surprenantes.

Die kontinuierliche Entwicklung in der Architektur und die neuen Lebensstile orientieren sich mehr und mehr an der Suche nach einem osmotischen Ambiente, in dem das Innere mit einer natürlichen Informalität an das Äußere grenzt. Aus diesem Grund ist es notwendig, eine fließende Oberfläche für die Gestaltung von Räumen zu finden, die auf einheitliche und diskrete Weise miteinander kommunizieren. **Airtech** wurde entwickelt, um in allen Räumlichkeiten zu passen, in denen der Designinstinkt eine unverwechselbare Note hinterlassen kann. Ein komplettes System von Oberflächen, Farben und Formaten definiert ein unerwartetes Potenzial.

La continua evolución arquitectónica y los nuevos estilos de vida están cada vez más orientados a la investigación de ambientes osmóticos en los que el interior invade el exterior con una informalidad natural y, precisamente por eso, encontrar una superficie fluida que se adapte a la creación de lugares que dialoguen entre sí de forma homogénea y discreta se convierte en una necesidad. **Airtech** se ha pensado para integrarse en todos los espacios en los que el propio instinto de diseño pueda dejar una marca distintiva. Un sistema completo de superficies, colores y formatos definen potencialidades inesperadas.



## MIAMI\_WHITE



## NEW YORK\_LIGHT GREY



V3

**R9**  
Classe B  
(naturale)



**R11**  
Classe C  
(strutturato)

DCOF>  
0,42 Wet  
(naturale/  
strutturato)

9 mm 3/8" ↑↓

### GRES FINE PORCELLANATO

FINE PORCELAIN STONEWARE / GRÈS CÉRAME FIN / FEINSTEINZEUG-KOLLEKTIONEN / GRES PORCELÁNICO FINO  
SQUADRATO - SQUARED - EQUARRI - REKTIFIZIERT - ESCUADRADO

9 mm 3/8" ↑↓		COLOR	SURFACE	60x120 23 <sup>5/8</sup> "x47 <sup>1/4</sup> "	80x80 31 <sup>1/2</sup> "x31 <sup>1/2</sup> "	40x80 15 <sup>3/4</sup> "x31 <sup>1/2</sup> "	60x60 23 <sup>5/8</sup> "x23 <sup>5/8</sup> "	30x60 11 <sup>4/5</sup> "x23 <sup>5/8</sup> "
AIRTECH		MIAMI_WHITE	NATURALE	760279 ■ FL-09100	760273 ■ FL-08100	760261 ■ FL-05800	760249 ■ FL-05800	760243 ■ FL-04900
			HIGH-GLOSSY	760285 ■ FL-10500	-	-	-	-
			STRUTTURATO	-	-	760267 ■ FL-05800	760255 ■ FL-05800	762197 ■ FL-04900
		NEW YORK_LIGHT GREY	NATURALE	760276 ■ FL-09100	760270 ■ FL-08100	760258 ■ FL-05800	760246 ■ FL-05800	760240 ■ FL-04900
			HIGH-GLOSSY	760282 ■ FL-10500	-	-	-	-
			STRUTTURATO	-	-	760264 ■ FL-05800	760252 ■ FL-05800	762194 ■ FL-04900



## STOCKHOLM\_GREIGE

## LONDON\_BLACK



V3

**R9**  
Classe B  
(naturale)

**R11**  
Classe C  
(strutturato)



DCOF>  
0,42 Wet  
(naturale/  
strutturato)

9 mm 3/8" ↑↓

### GRES FINE PORCELLANATO

FINE PORCELAIN STONEWARE / GRÈS CÉRAME FIN / FEINSTEINZEUG-KOLLEKTIONEN / GRES PORCELÁNICO FINO

SQUADRATO - SQUARED - EQUARRI - REKTIFIZIERT - ESCUADRADO

9 mm 3/8" ↑↓		COLOR	SURFACE	60x120 23 <sup>5/8"</sup> x47 <sup>1/4"</sup>	80x80 31 <sup>1/2"</sup> x31 <sup>1/2"</sup>	40x80 15 <sup>3/4"</sup> x31 <sup>1/2"</sup>	60x60 23 <sup>5/8"</sup> x23 <sup>5/8"</sup>	30x60 11 <sup>4/5"</sup> x23 <sup>5/8"</sup>
AIRTECH		STOCKHOLM_GREIGE	NATURALE	760281 ■ FL-09100	760275 ■ FL-08100	760263 ■ FL-05800	760251 ■ FL-05800	760245 ■ FL-04900
			HIGH-GLOSSY	760287 ■ FL-10500	-	-	-	-
			STRUTTURATO	-	-	760269 ■ FL-05800	760257 ■ FL-05800	762199 ■ FL-04900
		LONDON_BLACK	NATURALE	760278 ■ FL-09100	760272 ■ FL-08100	760260 ■ FL-05800	760248 ■ FL-05800	760242 ■ FL-04900
			HIGH-GLOSSY	760284 ■ FL-10500	-	-	-	-
			STRUTTURATO	-	-	760266 ■ FL-05800	760254 ■ FL-05800	762196 ■ FL-04900



## BASEL\_GREY

## BERLIN\_RED



V3

**R9**  
Classe B  
(naturale)



**R11**  
Classe C  
(strutturato)

DCOF>  
0,42 Wet  
(naturale/  
strutturato)

9 mm 3/8" ↑↓

### GRES FINE PORCELLANATO

FINE PORCELAIN STONEWARE / GRÈS CÉRAME FIN / FEINSTEINZEUG-KOLLEKTIONEN / GRES PORCELÁNICO FINO  
SQUADRATO - SQUARED - EQUARRI - REKTIFIZIERT - ESCUADRADO









9 mm 3/8" ↑↓		COLOR	SURFACE	60x120 23 <sup>5/8</sup> "x47 <sup>1/4</sup> "	80x80 31 <sup>1/2</sup> "x31 <sup>1/2</sup> "	40x80 15 <sup>3/4</sup> "x31 <sup>1/2</sup> "	60x60 23 <sup>5/8</sup> "x23 <sup>5/8</sup> "	30x60 11 <sup>4/5</sup> "x23 <sup>5/8</sup> "
AIRTECH		BASEL_GREY	NATURALE	760280 ■ FL-09100	760274 ■ FL-08100	760262 ■ FL-05800	760250 ■ FL-05800	760244 ■ FL-04900
			HIGH-GLOSSY	760286 ■ FL-10500	-	-	-	-
			STRUTTURATO	-	-	760268 ■ FL-05800	760256 ■ FL-05800	762198 ■ FL-04900
		BERLIN_RED	NATURALE	760277 ■ FL-09100	760271 ■ FL-08100	760259 ■ FL-05800	760247 ■ FL-05800	760241 ■ FL-04900
			HIGH-GLOSSY	760283 ■ FL-10500	-	-	-	-
			STRUTTURATO	-	-	760265 ■ FL-05800	760253 ■ FL-05800	762195 ■ FL-04900





# AIRTECH

9 mm 3/8" ↑

	COLOR	SURFACE	<b>30x30</b> 11 <sup>4/5</sup> "x11 <sup>4/5</sup> "  mosaico tessere 3x3 pz/box 11	<b>21x40</b> 8 <sup>1/4</sup> "x15 <sup>3/4</sup> "  listello sfalsato
AIRTECH		NATURALE	761048 ▲ FL-02000	761036 ■ FL-17200
		HIGH-GLOSSY	761042 ▲ FL-02300	761030 ■ FL-21000
		NATURALE	761049 ▲ FL-02000	761037 ■ FL-17200
		HIGH-GLOSSY	761043 ▲ FL-02300	761031 ■ FL-21000
		NATURALE	761050 ▲ FL-02000	761038 ■ FL-17200
		HIGH-GLOSSY	761044 ▲ FL-02300	761032 ■ FL-21000
		NATURALE	761047 ▲ FL-02000	761035 ■ FL-17200
		HIGH-GLOSSY	761041 ▲ FL-02300	761029 ■ FL-21000
		NATURALE	761045 ▲ FL-02000	761033 ■ FL-17200
		HIGH-GLOSSY	761039 ▲ FL-02300	760907 ■ FL-21000
		NATURALE	761046 ▲ FL-02000	761034 ■ FL-17200
		HIGH-GLOSSY	761040 ▲ FL-02300	761028 ■ FL-21000

**Per un effetto ottimale della posa, Florim suggerisce di mantenere 2 mm di fuga per pose monoformato e 3 mm per combinare formati misti** - For optimal installation results, Florim recommends maintaining a joint of 2 mm 1/12" for single format installations and 3 mm 1/8" to combine mixed formats. - Pour réaliser une pose parfait, Florim conseille de laisser 2 mm de joint pour la pose des monoformats et 3 mm pour les combinaisons de formats mixtes. - Um einen optimalen effekt beim verlegen zu erzielen empfiehlt Florim eine 2 mm fuge bei einformatigen verlegungen und 3 mm fuge bei formatkombinationen - Para lograr los máximos resultados en la posa del producto, Florim aconseja 2 mm de junta en aplicaciones monoformato y 3 mm en combinaciones de formatos mixtos

PEZZI SPECIALI/SPECIAL TRIMS/PIÈCES SPÉCIALES/FORMSTÜCKE/PIEZAS ESPECIALES

9 mm 3/8" ↑↓

	COLOR	SURFACE	4,6x60 1 4/5" x 2 3/8"	33x120x3 13" x 47 1/4" x 1 1/8"	33x120x3 13" x 47 1/4" x 1 1/8"	33x120x3 13" x 47 1/4" x 1 1/8"
			battiscopa	angolo gradino DX pz/box 2	gradino pz/box 2	angolo gradino SX pz/box 2
AIRTECH	MIAMI_WHITE	NATURALE	761078 ◆ FL-01600	761054 ▲ FL-31100	761066 ▲ FL-20400	761060 ▲ FL-31100
		HIGH-GLOSSY	761072 ◆ FL-01600	-	-	-
	NEW YORK_LIGHT GREY	NATURALE	761079 ◆ FL-01600	761055 ▲ FL-31100	761067 ▲ FL-20400	761061 ▲ FL-31100
		HIGH-GLOSSY	761073 ◆ FL-01600	-	-	-
	STOCKHOLM_GREIGE	NATURALE	761080 ◆ FL-01600	761056 ▲ FL-31100	761068 ▲ FL-20400	761062 ▲ FL-31100
		HIGH-GLOSSY	761074 ◆ FL-01600	-	-	-
	LONDON_BLACK	NATURALE	761077 ◆ FL-01600	761053 ▲ FL-31100	761065 ▲ FL-20400	761059 ▲ FL-31100
		HIGH-GLOSSY	761071 ◆ FL-01600	-	-	-
	BASEL_GREY	NATURALE	761075 ◆ FL-01600	761051 ▲ FL-31100	761063 ▲ FL-20400	761057 ▲ FL-31100
		HIGH-GLOSSY	761069 ◆ FL-01600	-	-	-
	BERLIN_RED	NATURALE	761076 ◆ FL-01600	761052 ▲ FL-31100	761064 ▲ FL-20400	761058 ▲ FL-31100
		HIGH-GLOSSY	761070 ◆ FL-01600	-	-	-



AIRTECH	scatola - box			pallet		
	pz	mq	kg	box	mq	kg
60x120	2	1,44	28,08	30	43,20	870
80x80	2	1,28	24,96	40	51,20	1030
40x80	3	0,96	18,53	56	53,76	1070
60x60	3	1,08	21,06	40	43,20	870
30x60	6	1,08	20,84	40	43,20	860

AIRTECH	scatola - box			pallet		
	pz	ml	kg	box	mq	kg
4,6x60 battiscopa	14	8,40	8,40	-	-	-

# AIRTECH OUTDOOR

## Vantaggi tecnici - Technical advantages - Avantages techniques Technische Vorteile - Ventajas técnicas

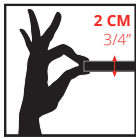

- Lastra monolitica compatta di spessore 2 cm squadrata e rettificata
- Compact monolithic slab 2 cm thick squared and rectified
- Dalle monolithique compacte de 2 cm d'épaisseur, équarrie et rectifiée
- Kompakte monolithische Platte, 2 cm dick, rechteckig und scharfkantig geschliffen
- Losa monolítica compacta de 2 cm de espesor, escuadrada y rectificada.



- INGELIVO
- FROST RESISTANT
- INGÉLIF
- FROSTBESTÄNDIG
- RESISTENTE A LA HELADA



- ELEVATA RESISTENZA AI CARICHI STATICI
- HIGH STATIC LOAD RESISTANCE
- RÉSISTANCE ÉLEVÉE AUX CHARGES STATIQUES
- HOHE STATISCHE BELASTBARKEIT
- ELEVADA RESISTENCIA A LAS CARGAS ESTÁTICAS

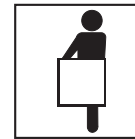

- FACILE DA POSARE
- EASY TO INSTALL
- FACILE À POSER
- VERLEGELEICHT
- FÁCIL DE COLOCAR



- ANTISCIVOLO R11
- ANTI SLIP R11
- ANTIDÉRAPANT R11
- RUTSCHFEST R11
- ANTIDESLIZANTE R11

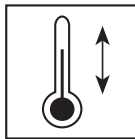

- RESISTENTE AGLI SBALZI TERMICI
- THERMAL SHOCK RESISTANT
- RÉSISTANT AUX ÉCARTS THERMIQUES
- TEMPERATURWECHSELBESTÄNDIG
- RESISTENTE A LAS OSCILACIONES TÉRMICAS



- FACILE DA PULIRE
- EASY TO CLEAN
- FACILE À NETTOYER
- REINIGUNGSLEICHT
- FÁCIL DE LIMPIAR

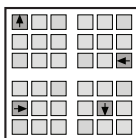

- RIMOVIBILE E RIUTILIZZABILE
- REMOVABLE AND REUSABLE
- DÉMONTABLE ET RÉUTILISABLE
- ENTFERNBAR UND WIEDERVERWENDBAR
- DESMONTABLE Y REUTILIZABLE



- INATTACCABILE DA AGENTI CHIMICI E MUFFE
- IMPERVIOUS TO ATTACK BY CHEMICALS OR MOULD
- RÉSISTANT AUX AGENTS CHIMIQUES ET AUX MOISSISSURES
- UNANGREIFBAR DURCH CHEMISCHE STOFFE UND SCHIMMEL
- RESISTENTE A LOS AGENTES QUÍMICOS Y A LOS MOHOS

## Applicazioni - Applications - Applications - Verlegung - Aplicaciones

- Posa diretta su erba
- Direct installation on grass
- Pose directe sur de l'herbe
- Verlegung direkt auf Rasen
- Colocación directa sobre hierba

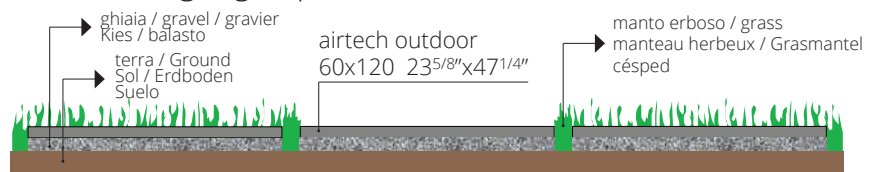

- Posa diretta su ghiaia
- Direct installation over gravel
- Pose direct sur du gravier
- Verlegung direkt auf Kies
- Colocación directa sobre grava



- Posa su massetto cementizio
- Installation on sand-cement screed
- Pose sur chape ciment
- Verlegung auf Zement-Unterbetonblock
- Colocación sobre contrapiso de hormigón

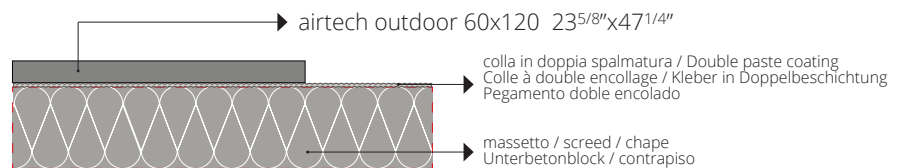

- Posa su piedini fissi o regolabili
- Installation on fixed or adjustable feet
- Pose sur pieds fixes ou réglables
- Verlegung auf feststehende oder regulierbare Füße
- Colocación sobre pies fijos o regulables

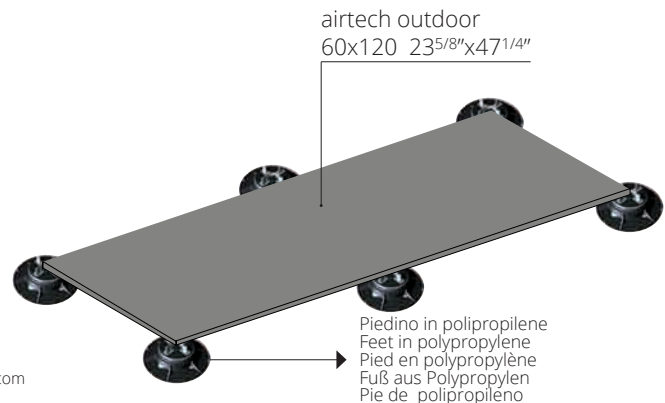

Per le specifiche di utilizzo dei sistemi sopraelevati vedi il sito florim.com  
For the specifics on use of raised systems visit the site florim.com  
Pour les caractéristiques d'utilisation des systèmes surélevés, voir le site florim.com  
Für die Nutzungsbedingungen der Doppelbodensysteme siehe Webseite florim.com  
Para las especificaciones de empleo de los sistemas sobreelevados consulte el sitio web florim.com

Le lastre ceramiche sono sottoposte a un trattamento di compattazione termica che assicura resistenza e durata nel tempo. Il bassissimo assorbimento d'acqua rende perciò il materiale ingelivo. Ciò può comportare ristagni d'acqua superficiali anche per materiale installato a regola d'arte. / Ceramic tiles undergo a compacting thermal treatment that ensures resistance and durability. The low level of water absorption makes the slabs frost resistant. This could result in superficial water stagnations even if materials are installed in a workmanlike manner. / Les carreaux de céramique subissent un traitement thermique de compactage qui assure résistance et durabilité. Le faible niveau d'absorption d'eau rend les dalles résistantes au gel. Il pourrait en résulter des stagnations d'eau superficielles, même si les dalles ont été installées dans les règles de l'art. / Die Keramikplatten werden einer thermischen Verdichtung unterzogen, welche die Widerstandsfähigkeit und Langlebigkeit sichert. Die extrem niedrige Wasseraufnahme macht das Material frostsicher. Die hohe Materialdichte kann, auch bei einer perfekten Verlegung, eine längere Abtrochnungszeit von angestaumtem Wasser zur Folge haben. / Las baldosas cerámicas se someten a un tratamiento de compactación térmica que asegura resistencia y durabilidad. La baja absorción de agua hace que las baldosas resistan al hielo. Esto podría resultar en estancamientos superficiales de agua, incluso si los materiales están instalados según las reglas del arte.



## MIAMI\_WHITE



## STOCKHOLM\_GREIGE



**R11  
CLASSE C**

DCOF>  
0,42 Wet



20 mm 3/4" ↑↓

## BASEL\_GREY



### GRES FINE PORCELLANATO

FINE PORCELAIN STONEWARE/GRES CERAME FIN/FEINSTEINZEUG-KOLLEKTIONEN/GRES PORCELLANICO FINO  
SQUADRATO - SQUARED - EQUARRI - REKTIFIZIERT - ESCUADRADO

				20 mm 3/4" ↑↓	
		COLOR	SURFACE	60x120 23 <sup>5</sup> / <sub>8</sub> "x47 <sup>1</sup> / <sub>4</sub> "	60x60 23 <sup>5</sup> / <sub>8</sub> "x23 <sup>5</sup> / <sub>8</sub> "
<b>AIRTECH</b>		MIAMI_WHITE	STRUTTURATO	761418 ■ FL-11300	761414 ■ FL-09300
		STOCKHOLM_GREIGE	STRUTTURATO	761420 ■ FL-11300	761416 ■ FL-09300
		BASEL_GREY	STRUTTURATO	761419 ■ FL-11300	761415 ■ FL-09300



**PEZZI SPECIALI**  
Special trims/Pièces spéciales/Formstücke  
Piezas especiales  
**pag 184/187**

	RESISTENZA ALLA FLESSIONE IN N/mm <sup>2</sup> N/mm <sup>2</sup> FLEXURAL STRENGTH TEST / RESISTANCE A LA FLEXION EN N/mm <sup>2</sup> / BIEGEFESTIGKEIT IN N/mm <sup>2</sup> / RESISTENCIA A LA FLEXION EN N/mm <sup>2</sup>	valore medio <b>52 N/mm<sup>2</sup></b>
	Forza di rottura in N (sp. > 7,5 mm) Breaking strength in N (sp. > 7,5 mm) / Force de rupture en N (sp. > 7,5 mm) / Bruchlast in N (Dicke > 7,5 mm) / Fuerza de rotura en N (gr. > 7,5 mm)	valore medio <b>14000 N</b>

<b>AIRTECH</b>	scatola - box			pallet		
	pz	mq	kg	box	mq	kg
60x120 20mm	1	0,72	32,26	30	21,60	1000
60x60 20mm	2	0,72	32,15	30	21,60	990





# BIOTECH

gres fine porcellanato  
fine porcelain stoneware  
grès cérame fin  
feinsteinzeug-kollektionen  
gres porcelánico fino





**Questa collezione fa parte del progetto CarbonZero, le superfici Carbon Neutral che compensano tutta la CO<sub>2</sub> emessa durante il loro ciclo di vita.**

*This collection is part of CarbonZero project, Florim's Carbon Neutral surfaces offset all the CO<sub>2</sub> emitted during their lifecycle.*



## BIOTECH

**Biotech** è la collezione di Florim che incontra i principi della Bioarchitettura. Destinata ai progetti architettonici, propone una selezione di pietre industriali in grande formato realizzate attraverso tecnologie innovative che permettono di spingersi oltre la consueta efficienza produttiva che Florim assicura nelle sue Fabbriche 4.0, con alti standard qualitativi in termini di performance tecniche ed estetiche. Un corpo tutta massa e superfici materiche che richiamano le pietre di ispirazione costituiscono il tratto distintivo di Biotech, realizzata utilizzando materie prime certificate e nuovi impianti capaci di decorare riducendo il consumo d'acqua, di energia e di emissioni nell'aria.

The **Biotech** collection by Florim embraces the principles of sustainable architecture. Devised for architecture projects, it contains a selection of industrial stones with large formats. They have been produced using innovative technologies that take things to an even higher level than the customary production efficiency found in Florim's Industry 4.0 factories, with high standards of technical and aesthetic performance. Biotech's distinguishing features are full bodies and surfaces whose material properties call to mind the stones that inspired them. The products are made using certified raw materials and new decorative systems with lower water consumption, energy consumption and emissions.

**Biotech** est la collection de Florim qui épouse les principes de la bio-architecture. Destinée aux projets architecturaux, elle propose une sélection de pierres industrielles grand format réalisées grâce à des technologies innovantes qui permettent de dépasser l'efficacité de production que Florim garantit habituellement dans ses Usines 4.0, avec des normes de qualité élevées en termes de performances techniques et esthétiques. Corps pleine masse et surfaces matérielles rappelant les pierres d'inspiration : telles sont les caractéristiques de Biotech, réalisée à partir de matières premières certifiées et avec de nouveaux équipements capables de réaliser des décors en réduisant la consommation d'eau, d'énergie et les émissions atmosphériques.

**Biotech** ist die Kollektion von Florim, die sich an den Prinzipien der Bio-Architektur orientiert. Sie ist für architektonische Projekte bestimmt und bietet eine Auswahl an großformatigem Kunststein, der mit innovativen Technologien hergestellt wird. Dadurch ist es möglich, über die übliche Produktionseffizienz hinauszugehen, die Florim in seinen 4.0 Produktionsstätten mit hohen Qualitätsstandards in Bezug auf technische und ästhetische Leistungen gewährleistet. Ein massiver Korpus und strukturierte, an Naturstein erinnernde Oberflächen sind das Markenzeichen von Biotech, das aus zertifizierten Rohstoffen und unter Verwendung hochmoderner Anlagen hergestellt wird. Diese ermöglichen hochwertige Einrichtungslösungen unter Reduzierung des Wasser- und Energieverbrauchs sowie der Luftemissionen.

**Biotech** es la colección de Florim inspirada en los principios de la bioarquitectura. Destinada a proyectos arquitectónicos, ofrece una selección de piedras industriales de gran formato realizadas con tecnologías innovadoras que permiten ir más allá de la habitual eficiencia productiva que Florim garantiza en sus Fábricas 4.0, con altos estándares de calidad en cuanto a prestaciones técnicas y estéticas. Un cuerpo todo masa y superficies matéricas que recuerdan las piedras de inspiración son el rasgo distintivo de Biotech, creada con materias primas certificadas y nuevos sistemas de decoración que reducen al mismo tiempo el consumo de agua, energía y emisiones contaminantes.



# BIOTECH

## CREMA STONE



## STONEWOOD



**R10**  
**CLASSE B**  
(naturele)

**R10**  
(canneté)

**R11**  
(R11 PTV)

DCOF>  
0,42 Wet

BS EN 16165  
ANNEX C  
>36 Wet  
slider 96  
(R11 PTV)

9 mm 3/8" ↑↓



**R9**  
(soft)

**R10**  
**CLASSE B**  
(naturele)

6 mm 1/4" ↑↓

FLORIM OVERSIZE  
**magnum**

### GRES FINE PORCELLANATO

FINE PORCELAIN STONEWARE / GRÈS CÉRAMÉ FIN / FEINSTEINZEUG-KOLLEKTIONEN / GRES PORCELÁNICO FINO

SQUADRATO - SQUARED - EQUARRI - REKTIFIZIERT - ESCUADRADO

9 mm 3/8" ↑↓		COLOR	SURFACE	120x120 47 <sup>1/4</sup> "x47 <sup>1/4</sup> "	80x180 31 <sup>1/2</sup> "x70 <sup>6/7</sup> "	60x120 23 <sup>5/8</sup> "x47 <sup>1/4</sup> "	60x60 23 <sup>5/8</sup> "x23 <sup>5/8</sup> "	30x60 11 <sup>4/5</sup> "x23 <sup>5/8</sup> "
BIOTECH	CREMA STONE	NATURALE/MATTE	-	778856 ■ FL-09870	778861 ■ FL-09100	779221 ■ FL-05800	779500 ■ FL-04900	
		R11 PTV	779557 ■ FL-06650	-	779560 ■ FL-09100	-	-	
		CANNETÉ	-	-	778865 ■ FL-09500	-	-	
	STONEWOOD	NATURALE/MATTE	-	778858 ■ FL-09870	778863 ■ FL-09100	779223 ■ FL-05800	779502 ■ FL-04900	
		R11 PTV	779558 ■ FL-06650	-	779561 ■ FL-09100	-	-	
		CANNETÉ	-	-	778867 ■ FL-09500	-	-	
6 mm 1/4" ↑↓		COLOR	SURFACE	120x280 47 <sup>1/4</sup> "x110 <sup>1/4</sup> "	120x240 47 <sup>1/4</sup> "x94 <sup>1/2</sup> "	120x120 47 <sup>1/4</sup> "x47 <sup>1/4</sup> "	60x120 23 <sup>5/8</sup> "x47 <sup>1/4</sup> "	
BIOTECH	CREMA STONE	NATURALE/MATTE	778773 ■ FL-10800	778786 ■ FL-09900	778793 ■ FL-08400	778798 ■ FL-07700		
		SOFT	779015 ■ FL-12000	779019 ■ FL-10900	779022 ■ FL-09250	779025 ■ FL-08350		
	STONEWOOD	NATURALE/MATTE	779016 ■ FL-10800	779020 ■ FL-09900	779023 ■ FL-08400	779026 ■ FL-07700		
		SOFT	778777 ■ FL-12000	778791 ■ FL-10900	778796 ■ FL-09250	778801 ■ FL-08350		

## LAPIS GREIGE



## SERIZZO STONE



**R10**  
**CLASSE B**  
(naturale)

**R10**  
(canneté)

**R11**  
(R11 PTV)

BS EN 16165  
ANNEX C  
>36 Wet  
slider 96  
(R11 PTV)

9 mm 3/8" ↑↓



**R9**  
(soft)

**R10**  
**CLASSE B**  
(naturale)

6 mm 1/4" ↑↓

FLORIM OVERSIZE  
**magnUm**

**GRES FINE PORCELLANATO**  
FINE PORCELAIN STONEWARE / GRÈS CÉRAME FIN / FEINSTEINZEUG-KOLLEKTIONEN / GRES PORCELÁNICO FINO  
SQUADRATO - SQUARED - EQUARRI - REKTIFIZIERT - ESCUADRADO

9 mm 3/8" ↑↓	COLOR	SURFACE	120x120 47 <sup>1/4"</sup> x47 <sup>1/4"</sup>	80x180 31 <sup>1/2"</sup> x70 <sup>5/8"</sup>	60x120 23 <sup>5/8"</sup> x47 <sup>1/4"</sup>	60x60 23 <sup>5/8"</sup> x23 <sup>5/8"</sup>	30x60 11 <sup>4/8"</sup> x23 <sup>5/8"</sup>
	LAPIS GREIGE	NATURALE/MATTE	-	778857 ■ FL-09870	778862 ■ FL-09100	779222 ■ FL-05800	779501 ■ FL-04900
		R11 PTV	779556 ■ FL-06650	-	779559 ■ FL-09100	-	-
		CANNETÉ	-	-	778866 ■ FL-09500	-	-
	SERIZZO STONE	NATURALE/MATTE	-	778855 ■ FL-09870	778860 ■ FL-09100	779220 ■ FL-05800	779499 ■ FL-04900

6 mm 1/4" ↑↓	COLOR	SURFACE	120x280 47 <sup>1/4"</sup> x110 <sup>1/4"</sup>	120x240 47 <sup>1/4"</sup> x94 <sup>1/2"</sup>	120x120 47 <sup>1/4"</sup> x47 <sup>1/4"</sup>	60x120 23 <sup>5/8"</sup> x47 <sup>1/4"</sup>
	LAPIS GREIGE	NATURALE/MATTE	778774 ■ FL-10800	778789 ■ FL-09900	778794 ■ FL-08400	778799 ■ FL-07700
		SOFT	779014 ■ FL-12000	779018 ■ FL-10900	779021 ■ FL-09250	779024 ■ FL-08350
	SERIZZO STONE	NATURALE/MATTE	778772 ■ FL-10800	778782 ■ FL-09900	778792 ■ FL-08400	778797 ■ FL-07700

# BIOTECH

## SOAP STONE



V2

R9  
(soft)

DCOF >  
0,42 Wet

9 mm 3/8" ↑↓

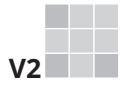

V2

R9  
(soft)

6 mm 1/4" ↑↓

FLORIM OVERSIZE  
magnum

**GRES FINE PORCELLANATO**  
FINE PORCELAIN STONEWARE / GRÈS CÉRAMÉ FIN / FEINSTEINZEUG-KOLLEKTIONEN / GRES PORCELÁNICO FINO  
SQUADRATO - SQUARED - EQUARRI - REKTIFIZIERT - ESCUADRADO

9 mm 3/8" ↑↓	COLOR	SURFACE	80x180 31 1/2" x 70 5/7"	60x120 23 5/8" x 47 1/4"	60x60 23 5/8" x 23 5/8"	30x60 11 1/5" x 23 5/8"	
<b>BIOTECH</b>		SOAP STONE	SOFT	778859 ■ FL-10850	778864 ■ FL-09940	779224 ■ FL-06350	779503 ■ FL-05400



6 mm 1/4" ↑↓	COLOR	SURFACE	120x280 47 3/4" x 110 1/4"	120x240 47 3/4" x 94 1/2"	120x120 47 3/4" x 47 3/4"	60x120 23 5/8" x 47 1/4"	
<b>BIOTECH</b>		SOAP STONE	SOFT	778775 ■ FL-12000	778790 ■ FL-10900	778795 ■ FL-09250	778800 ■ FL-08350

## GRES FINE PORCELLANATO

FINE PORCELAIN STONEWARE / GRÈS CÉRAMÉ FIN / FEINSTEINZEUG-KOLLEKTIONEN / GRES PORCELÁNICO FINO  
 SQUADRATO - SQUARED - EQUARRI - REKTIFIZIERT - ESCUADRADO

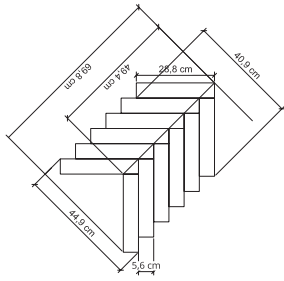

9 mm 3/8" ↑↓		COLOR	SURFACE	29x38 11 <sup>3/7"</sup> x15" pz/box 6
<b>BIOTECH</b>		TOUCH CREMA STONE	MIX MATTE/CANNETÉ	779353 ▲ FL-02700
		TOUCH STONEWOOD	MIX MATTE/CANNETÉ	779354 ▲ FL-02700
		TOUCH LAPIS GREIGE	MIX MATTE/CANNETÉ	779355 ▲ FL-02700

9 mm 3/8" ↑↓		COLOR	SURFACE	
HERRINGBONE				

<b>BIOTECH</b>		CREMA STONE	MATTE	779361 ■ FL-23600
		STONEWOOD	MATTE	779362 ■ FL-23600
		LAPIS GREIGE	MATTE	779363 ■ FL-23600

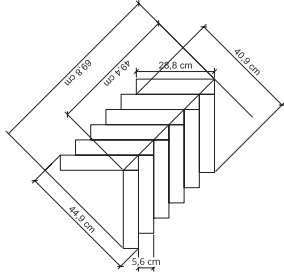







6 mm 1/4" ↑↓		COLOR	SURFACE	33,5x37 13 <sup>1/5"</sup> x14 <sup>4/7"</sup> pz/box 6
<b>BIOTECH</b>		SQUARES SERIZZO STONE	NATURALE/MATTE	779356 ▲ FL-02200
		SQUARES SOAP STONE	SOFT	779357 ▲ FL-02200

6 mm 1/4" ↑↓		COLOR	SURFACE	
HERRINGBONE				

<b>BIOTECH</b>		CREMA STONE	MATTE	779358 ■ FL-26800
		STONEWOOD	MATTE	779359 ■ FL-26800
		LAPIS GREIGE	MATTE	779360 ■ FL-26800

# BIOTECH

PEZZI SPECIALI/SPECIAL TRIMS/PIÈCES SPÉCIALES/FORMSTÜCKE/PIEZAS ESPECIALES

9 mm 3/8" 				<b>4,6x120</b> <small>1 4/5" x 4 7/8"</small>  battiscopa	<b>33x120x3</b> <small>1 3/8" x 4 7/8" x 1 1/8"</small>  gradino pz/box 2
	COLOR		SURFACE		
<b>BIOTECH</b>		CREMA STONE	NATURALE	779580 ◆ FL-01600	779032 ▲ FL-20400
		STONEWOOD	NATURALE	779584 ◆ FL-01600	779036 ▲ FL-20400
		LAPIS GREIGE	NATURALE	779581 ◆ FL-01600	779033 ▲ FL-20400
		SERIZZO STONE	NATURALE	779582 ◆ FL-01600	779034 ▲ FL-20400
		SOAP STONE	SOFT	779583 ◆ FL-01600	779035 ▲ FL-20400

FLORIM OVERSIZE  
**magnUm**

**120x280/120x240/120x120/60x120**  
 Specifica Imballo pag.  
 Packaging specifications on page  
 Spécifications d'emballage à page  
 Verpackungsdetail Seite  
 Especificaciones de embalaje a la página  
**194/195**

**Per un effetto ottimale della posa, Florim suggerisce di mantenere 2 mm di fuga per pose monoformato e 3 mm per combinare formati misti** - For optimal installation results, Florim recommends maintaining a joint of 2 mm 1/12" for single format installations and 3 mm 1/8" to combine mixed formats. - Pour réaliser une pose parfait, Florim conseille de laisser 2 mm de joint pour la pose des monoformats et 3 mm pour les combinaisons de formats mixtes. - Um einen optimalen effekt beim verlegen zu erzielen empfiehlt Florim eine 2 mm fugе bei einformatigen verlegungen und 3 mm fugе bei formatkombinationen - Para lograr los máximos resultados en la posa del producto, Florim aconseja 2 mm de junta en aplicaciones monoformato y 3 mm en combinaciones de formatos mixtos.

BIOTECH	scatola - box			pallet		
	pz	mq	kg	box	mq	kg
80x180	2	2,88	59,33	20	57,60	1240
60x120	2	1,44	28,08	30	43,20	870
60x60	3	1,08	21,06	40	43,20	870
30x60	6	1,08	20,84	40	43,20	860
HERRINGBONE	4	0,81	11,73	16	12,96	220

BIOTECH	scatola - box			pallet		
	pz	ml	kg	box	mq	kg
4,6x120 battiscopa	6	7,20	7,20	-	-	-





# BIOTECH OUTDOOR

## Vantaggi tecnici - Technical advantages - Avantages techniques Technische Vorteile - Ventajas técnicas

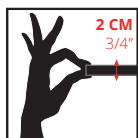

- Lastra monolitica compatta di spessore 2 cm squadrata e rettificata
- Compact monolithic slab 2 cm thick squared and rectified
- Dalle monolithique compacte de 2 cm d'épaisseur, équarrie et rectifiée
- Kompakte monolithische Platte, 2 cm dick, rechteckig und scharfkantig geschliffen
- Losa monolítica compacta de 2 cm de espesor, escuadrada y rectificada.



- INGELIVO
- FROST RESISTANT
- INGÉLIF
- FROSTBESTÄNDIG
- RESISTENTE A LA HELADA



- ELEVATA RESISTENZA AI CARICHI STATICI
- HIGH STATIC LOAD RESISTANCE
- RÉSISTANCE ÉLEVÉE AUX CHARGES STATIQUES
- HOHE STATISCHE BELASTBARKEIT
- ELEVADA RESISTENCIA A LAS CARGAS ESTÁTICAS



- FACILE DA POSARE
- EASY TO INSTALL
- FACILE À POSER
- VERLEGELEICHT
- FÁCIL DE COLOCAR



- ANTISCIVOLO R11
- ANTI SLIP R11
- ANTIDÉRAPANT R11
- RUTSCHFEST R11
- ANTIDESLIZANTE R11

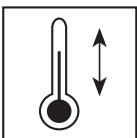

- RESISTENTE AGLI SBALZI TERMICI
- THERMAL SHOCK RESISTANT
- RÉSISTANT AUX ÉCARTS THERMIQUES
- TEMPERATURWECHSELBESTÄNDIG
- RESISTENTE A LAS OSCILACIONES TÉRMICAS



- FACILE DA PULIRE
- EASY TO CLEAN
- FACILE À NETTOYER
- REINIGUNGSLEICHT
- FÁCIL DE LIMPIAR

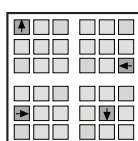

- RIMOVIBILE E RIUTILIZZABILE
- REMOVABLE AND REUSABLE
- DÉMONTABLE ET RÉUTILISABLE
- ENTFERNBAR UND WIEDERVERWENDBAR
- DESMONTABLE Y REUTILIZABLE



- INATTACCABILE DA AGENTI CHIMICI E MUFFE
- IMPERVIOUS TO ATTACK BY CHEMICALS OR MOULD
- RÉSISTANT AUX AGENTS CHIMIQUES ET AUX MOISSISSURES
- UNANGREIFBAR DURCH CHEMISCHE STOFFE UND SCHIMMEL
- RESISTENTE A LOS AGENTES QUÍMICOS Y A LOS MOHOS

## Applicazioni - Applications - Applications - Verlegung - Aplicaciones

- Posa diretta su erba
- Direct installation on grass
- Pose directe sur de l'herbe
- Verlegung direkt auf Rasen
- Colocación directa sobre hierba



- Posa diretta su ghiaia
- Direct installation over gravel
- Pose direct sur du gravier
- Verlegung direkt auf Kies
- Colocación directa sobre grava



- Posa su massetto cementizio
- Installation on sand-cement screed
- Pose sur chape ciment
- Verlegung auf Zement-Unterbetonblock
- Colocación sobre contrapiso de hormigón

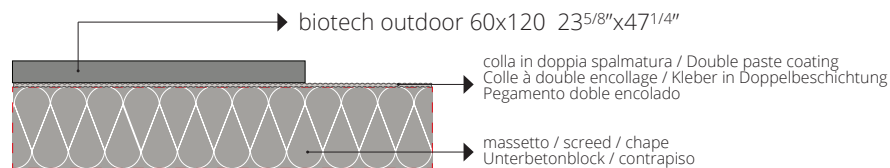

- Posa su piedini fissi o regolabili
- Installation on fixed or adjustable feet
- Pose sur pieds fixes ou réglables
- Verlegung auf feststehende oder regulierbare Füße
- Colocación sobre pies fijos o regulables

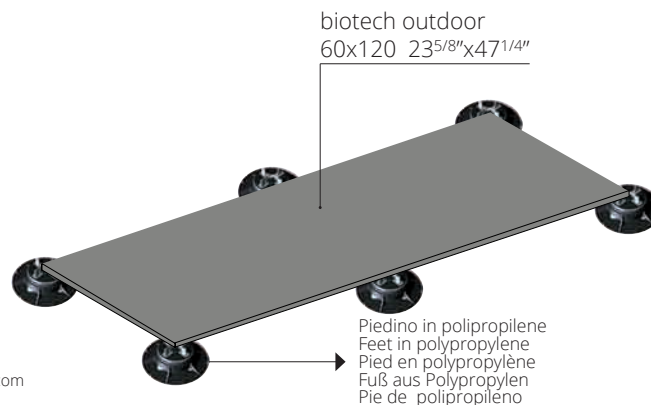

Per le specifiche di utilizzo dei sistemi sopraelevati vedi il sito florim.com  
For the specifics on use of raised systems visit the site florim.com  
Pour les caractéristiques d'utilisation des systèmes surélevés, voir le site florim.com  
Für die Nutzungsbedingungen der Doppelbodensysteme siehe Webseite florim.com  
Para las especificaciones de empleo de los sistemas sobreelevados consulte el sitio web florim.com

Le lastre ceramiche sono sottoposte a un trattamento di compattazione termica che assicura resistenza e durata nel tempo. Il bassissimo assorbimento d'acqua rende perciò il materiale ingelivo. Ciò può comportare ristagni d'acqua superficiali anche per materiale installato a regola d'arte. / Ceramic tiles undergo a compacting thermal treatment that ensures resistance and durability. The low level of water absorption makes the slabs frost resistant. This could result in superficial water stagnations even if materials are installed in a workmanlike manner. / Les carreaux de céramique subissent un traitement thermique de compactage qui assure résistance et durabilité. Le faible niveau d'absorption d'eau rend les dalles résistantes au gel. Il pourrait en résulter des stagnations d'eau superficielles, même si les dalles ont été installées dans les règles de l'art. / Die Keramikplatten werden einer thermischen Verdichtung unterzogen, welche die Widerstandsfähigkeit und Langlebigkeit sichert. Die extrem niedrige Wasseraufnahme macht das Material frostsicher. Die hohe Materialdichte kann, auch bei einer perfekten Verlegung, eine längere Abtrochnungszeit von angestaumtem Wasser zur Folge haben. / Las baldosas cerámicas se someten a un tratamiento de compactación térmica que asegura resistencia y durabilidad. La baja absorción de agua hace que las baldosas resistan al hielo. Esto podría resultar en estancamientos superficiales de agua, incluso si los materiales están instalados según las reglas del arte.

## CREMA STONE



## STONEWOOD



**V2**  
CREMA STONE  
SOAP STONE

**V3**  
STONEWOOD  
LAPIS GREIGE  
SERIZZO STONE

## LAPIS GREIGE



## SERIZZO STONE

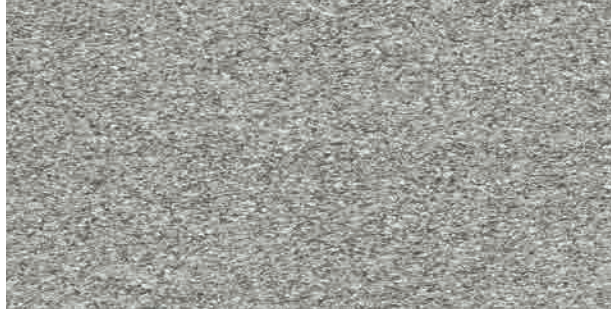

**R11**  
**CLASSE C**  
(strutturato)

DCOF>  
0,42 Wet

20 mm 3/4" ↑↓

## SOAP STONE

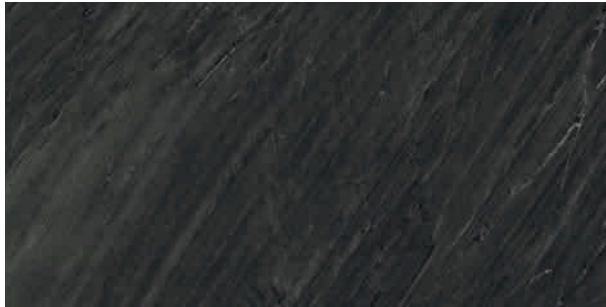

### GRES FINE PORCELLANATO

FINE PORCELAIN STONEWARE/GRES CERAME FIN/FEINSTEINZEUG-KOLLEKTIONEN/GRES PORCELANICO FINO  
SQUADRATO - SQUARED - EQUARRI - REKTIFIZIERT - ESCUADRADO

20 mm 3/4" ↑↓

	COLOR	SURFACE	60x120 23 <sup>5</sup> / <sub>8</sub> "x47 <sup>1</sup> / <sub>4</sub> "
	 CREMA STONE	STRUTTURATO	776402 ■ FL-10300
	 STONEWOOD	STRUTTURATO	776405 ■ FL-10300
<b>BIOTECH</b>	 LAPIS GREIGE	STRUTTURATO	776403 ■ FL-10300
	 SERIZZO STONE	STRUTTURATO	776400 ■ FL-10300
	 SOAP STONE	STRUTTURATO	776406 ■ FL-10300

### PEZZI SPECIALI

Special trims/Pièces spéciales/Formstücke  
Piezas especiales  
**pag 184/187**

	RESISTENZA ALLA FLESSIONE IN N/mm <sup>2</sup> N/mm <sup>2</sup> FLEXURAL STRENGTH TEST / RESISTANCE A LA FLEXION EN N/mm <sup>2</sup> / BIEGEFESTIGKEIT IN N/mm <sup>2</sup> / RESISTENCIA A LA FLEXION EN N/mm <sup>2</sup>	valore medio <b>52 N/mm<sup>2</sup></b>
	Forza di rottura in N (sp. > 7,5 mm) Breaking strength in N (sp. > 7,5 mm) / Force de rupture en N (sp. > 7,5 mm) / Bruchlast in N (Dicke > 7,5 mm) / Fuerza de rotura en N (gr. > 7,5 mm)	valore medio <b>14000 N</b>

BIOTECH	scatola - box			pallet		
	pz	mq	kg	box	mq	kg
60x120 20mm	1	0,72	32,26	30	21,60	1000





# B&W\_MARBLE

gres fine porcellanato  
fine porcelain stoneware  
grès cérame fin  
feinsteinzeug-kollektionen  
gres porcelánico fino







## B&W\_MARBLE

L'idea di dualismo cromatico di "B&W" evolve in "**B&W\_Marble**", la nuova collezione progettuale del marchio Architectural design. La serie propone la purezza di tinta dei due opposti di luce per eccellenza, il bianco e il nero, che diventa lo sfondo dal quale prende vita un "pantone lapideo" composto da un ventaglio di elementi dalle forme più o meno regolari che ricordano le venature del marmo. Il marmo viene inteso come una materia fortemente progettuale legata alla terra e alla natura, rafforzando la proposta di osmosi tra ambiente naturale e ambiente costruito tipica del marchio Florim.

The "B&W" idea of chromatic dualism evolves into "**B&W\_Marble**", the new Architectural design collection for architectural projects. The series offers the purity of shades of the most sharply contrasting opposites, white and black, which become the background for a range of "pantone colours in stone", with an assortment of elements of more or less regular shapes that evoke the vein patterns of marble. Marble is viewed here as a material with strong architectural connotations, linked to the earth and nature, reinforcing the concept of osmosis between the natural and built environment typical of the Florim brand.

L'idée de dualisme chromatique de «B&W» évolue en «**B&W\_Marble**», la nouvelle collection conceptuelle de la marque Architectural design. Cette série propose la pureté de teinte des deux opposés par excellence, le blanc et le noir, qui devient le fond donnant vie à un « pantone de pierre » composé d'un éventail d'éléments aux formes plus ou moins régulières qui rappellent les veinures du marbre. Le marbre est perçu comme une matière fortement conceptuelle liée à la terre et à la nature, renforçant ainsi la proposition d'osmose entre environnement naturel et environnement construit typique de la marque Florim.

Aus der Idee des chromatischen Dualismus von „B&W“ entsteht „**B&W\_Marble**“, die neue Designkollektion der Marke Architectural design. Die Serie bietet die Farbreinheit der zwei Lichtgegensätze par excellence, Schwarz und Weiß. Sie bildet den Hintergrund für eine „steingraue Pantone-Farbpalette“, welche sich aus einer Reihe von Elementen mit mehr oder weniger regelmäßigen Formen zusammensetzt, die an Marmoradern erinnern. Unter Marmor ist ein äußerst gestaltbares Material zu verstehen, das mit der Erde und Natur verbunden ist und die Osmoselösung zwischen dem natürlichen Raum und dem vom Menschen erschaffenen Raum verstärkt. Eine Lösung, die für das Markenzeichen Florim so typisch ist.

La idea de dualismo cromático de B&W evoluciona en **B&W\_Marble**, la nueva colección de diseño de la marca Architectural design. La serie propone la pureza cromática de los dos opuestos de luz por excelencia, el blanco y el negro, que deviene el fondo en el que cobra vida un "pantone lítico" compuesto por un abanico de elementos de formas, más o menos regulares, que recuerdan las vetas del mármol. El mármol es considerado una materia de diseño, fuertemente vinculada a la tierra y a la naturaleza, reforzando la propuesta de ósmosis entre el ambiente natural y el ambiente construido, típica de la marca Florim.

# B&W\_MARBLE

## WHITE



## BLACK

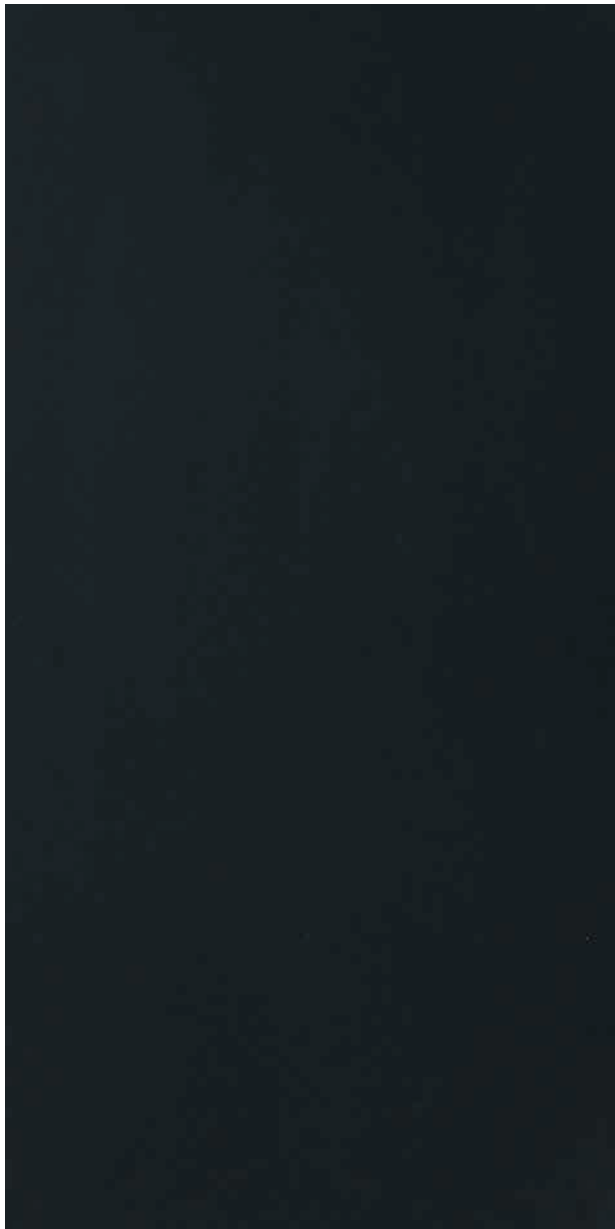

V1

R9  
(naturale)

DCOF>  
0,42 Wet  
(naturale)

9 mm 3/8" ↑↓



V1

R9  
(naturale)

DCOF>  
0,42 Wet  
(naturale)

6 mm 1/4" ↑↓

FLOORM OVERSIZE  
**magnUm**

### GRES FINE PORCELLANATO

FINE PORCELAIN STONEWARE / GRÈS CÉRAME FIN / FEINSTEINZEUG-KOLLEKTIONEN / GRES PORCELÁNICO FINO  
SQUADRATO - SQUARED - EQUARRI - REKTIFIZIERT - ESCUADRADO

9 mm 3/8" ↑↓		COLOR	SURFACE	60x120 23 <sup>5/8"</sup> x47 <sup>1/4"</sup>	60x60 23 <sup>5/8"</sup> x23 <sup>5/8"</sup>	30x60 11 <sup>4/5"</sup> x23 <sup>5/8"</sup>
<b>B&amp;W_MARBLE</b>		WHITE	NATURALE	755567 ■ FL-09100	755473 ■ FL-05800	754462 ■ FL-04900
			HIGH-GLOSSY	755569 ■ FL-10500	755475 ■ FL-07300	754464 ■ FL-06500
		BLACK	NATURALE	755566 ■ FL-09100	755474 ■ FL-05800	754463 ■ FL-04900
			HIGH-GLOSSY	755568 ■ FL-10500	755476 ■ FL-07300	754465 ■ FL-06500

6 mm 1/4" ↑↓		COLOR	SURFACE	160x320 63"x126"	120x280 47 <sup>1/4"</sup> x110 <sup>1/4"</sup>	120x240 47 <sup>1/4"</sup> x94 <sup>1/2"</sup>	120x120 47 <sup>1/4"</sup> x47 <sup>1/4"</sup>	60x120 23 <sup>5/8"</sup> x47 <sup>1/4"</sup>
<b>B&amp;W_MARBLE</b>		WHITE	NATURALE	751164 ■ FL-14500	765518 ■ FL-10800	751165 ■ FL-09900	751167 ■ FL-08400	751166 ■ FL-07700
			HIGH-GLOSSY	751171 ■ FL-17200	765527 ■ FL-13400	751172 ■ FL-12400	751174 ■ FL-10800	751173 ■ FL-10300
		BLACK	NATURALE	751178 ■ FL-14500	765515 ■ FL-10800	751179 ■ FL-09900	751181 ■ FL-08400	751180 ■ FL-07700
			HIGH-GLOSSY	751185 ■ FL-17200	765525 ■ FL-13400	751186 ■ FL-12400	751188 ■ FL-10800	751187 ■ FL-10300

WAVE

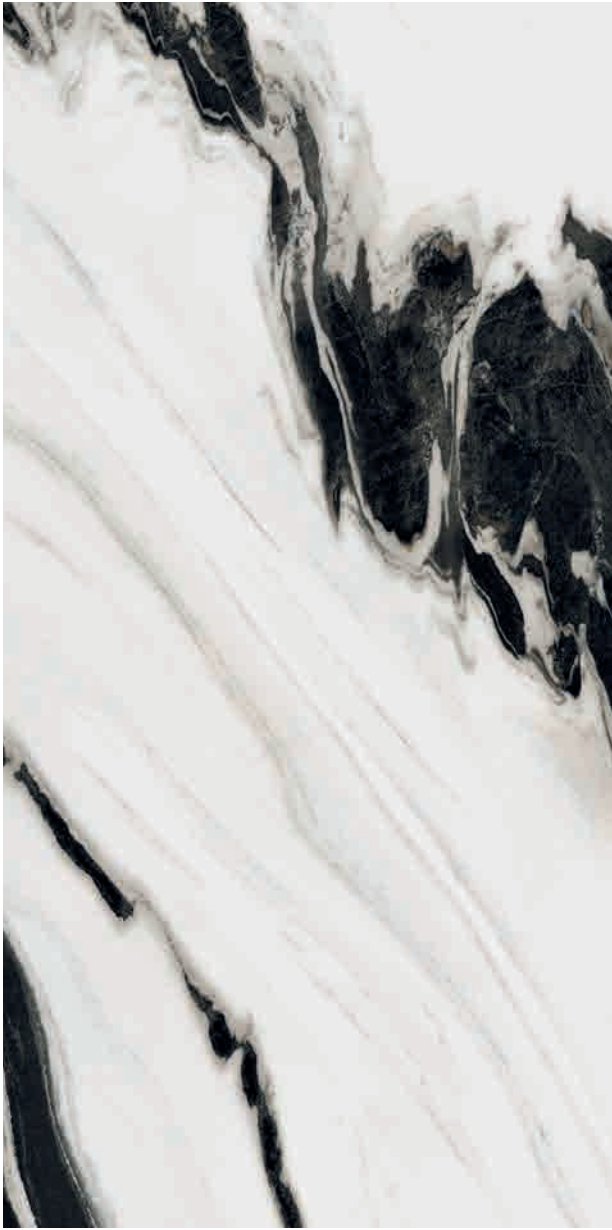

FRAGMENT





R9  
(naturale)

DCOF>  
0,42 Wet  
(naturale)

9 mm 3/8" ↑↓

**GRES FINE PORCELLANATO**  
FINE PORCELAIN STONEWARE / GRÈS CÉRAME FIN / FEINSTEINZEUG-KOLLEKTIONEN / GRES PORCELÁNICO FINO  
SQUADRATO - SQUARED - EQUARRI - REKTIFIZIERT - ESCUADRADO

9 mm 3/8" ↑↓		COLOR	SURFACE	60x120 23 <sup>5/8"</sup> x47 <sup>1/4"</sup>	60x60 23 <sup>5/8"</sup> x23 <sup>5/8"</sup>	30x60 11 <sup>4/8"</sup> x23 <sup>5/8"</sup>
<b>B&amp;W_MARBLE</b>		WAVE	NATURALE	766391 ■ FL-09100	766483 ■ FL-05800	766481 ■ FL-04900
			HIGH-GLOSSY	766392 ■ FL-10500	766484 ■ FL-07300	766482 ■ FL-06500
		FRAGMENT	NATURALE	766399 ■ FL-09100	766597 ■ FL-05800	766581 ■ FL-04900
			HIGH-GLOSSY	766398 ■ FL-10500	766602 ■ FL-07300	766592 ■ FL-06500



# B&W\_MARBLE

## BREACH



## PEBBLE



V3

R9  
(naturale)

DCOF >  
0,42 Wet  
(naturale)

9 mm 3/8" ↑ ↓



V3

R9  
(naturale)

DCOF >  
0,42 Wet  
(naturale)

6 mm 1/4" ↑ ↓



FLOREM OVERSIZE  
magnum

### GRES FINE PORCELLANATO

FINE PORCELAIN STONEWARE / GRÈS CÉRAME FIN / FEINSTEINZEUG-KOLLEKTIONEN / GRES PORCELÁNICO FINO

SQUADRATO - SQUARED - EQUARRI - REKTIFIZIERT - ESCUADRADO

9 mm 3/8" ↑ ↓

	COLOR	SURFACE	60x120 23 <sup>5/8"</sup> x47 <sup>1/4"</sup>	60x60 23 <sup>5/8"</sup> x23 <sup>5/8"</sup>	30x60 11 <sup>4/5"</sup> x23 <sup>5/8"</sup>	
<b>B&amp;W_MARBLE</b>		BREACH	NATURALE	766401 ■ FL-09100	766598 ■ FL-05800	766587 ■ FL-04900
			HIGH-GLOSSY	766402 ■ FL-10500	766603 ■ FL-07300	766593 ■ FL-06500
		PEBBLE	NATURALE	766404 ■ FL-09100	-	-
			HIGH-GLOSSY	766403 ■ FL-10500	-	-

6 mm 1/4" ↑ ↓

	COLOR	SURFACE	160x320 63"x126"	120x280 47 <sup>1/4"</sup> x110 <sup>1/4"</sup>	120x240 47 <sup>1/4"</sup> x94 <sup>1/2"</sup>	120x120 47 <sup>1/4"</sup> x47 <sup>1/4"</sup>	60x120 23 <sup>5/8"</sup> x47 <sup>1/4"</sup>	
<b>B&amp;W_MARBLE</b>		BREACH	NATURALE	765497 ■ FL-14500	765521 ■ FL-10800	765539 ■ FL-09900	765566 ■ FL-08400	765586 ■ FL-07700
			HIGH-GLOSSY	765503 ■ FL-17200	765533 ■ FL-13400	765545 ■ FL-12400	765575 ■ FL-10800	765596 ■ FL-10300

## FLOW



## FALL





V3

R9  
(naturale)











DCOF >  
0,42 Wet  
(naturale)

9 mm 3/8" ↑↓

**GRES FINE PORCELLANATO**  
FINE PORCELAIN STONEWARE / GRÈS CÉRAME FIN / FEINSTEINZEUG-KOLLEKTIONEN / GRES PORCELÁNICO FINO  
SQUADRATO - SQUARED - EQUARRI - REKTIFIZIERT - ESCUADRADO

9 mm 3/8" ↑↓		COLOR	SURFACE	60x120 23 <sup>5/8"</sup> x47 <sup>1/4"</sup>
<b>B&amp;W_MARBLE</b>		FLOW	NATURALE	766406 ■ FL-09100
			HIGH-GLOSSY	766405 ■ FL-10500
		FALL	NATURALE	766408 ■ FL-09100
			HIGH-GLOSSY	766407 ■ FL-10500

# B&W\_MARBLE







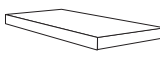
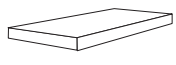

9 mm 3/8" ↑				<b>30x30</b> 1 1/4"x1 1/4"  mosaico tessere 3x3 pz/box 11	<b>21x40</b> 8 1/4"x15 3/4"  listello sfalsato
B&W_MARBLE		WHITE	NATURALE	767385 ▲ FL-02000	767401 ■ FL-17200
			HIGH-GLOSSY	767376 ▲ FL-02300	767393 ■ FL-21000
		BLACK	NATURALE	767386 ▲ FL-02000	767402 ■ FL-17200
			HIGH-GLOSSY	767377 ▲ FL-02300	767394 ■ FL-21000
		WAVE	NATURALE	767387 ▲ FL-02000	767403 ■ FL-17200
			HIGH-GLOSSY	767378 ▲ FL-02300	767395 ■ FL-21000
		FRAGMENT	NATURALE	767388 ▲ FL-02000	767404 ■ FL-17200
			HIGH-GLOSSY	767379 ▲ FL-02300	767396 ■ FL-21000
		BREACH	NATURALE	767389 ▲ FL-02000	767405 ■ FL-17200
			HIGH-GLOSSY	767380 ▲ FL-02300	767397 ■ FL-21000
		PEBBLE	NATURALE	767390 ▲ FL-02000	767406 ■ FL-17200
			HIGH-GLOSSY	767381 ▲ FL-02300	767398 ■ FL-21000
		FLOW	NATURALE	767391 ▲ FL-02000	767407 ■ FL-17200
			HIGH-GLOSSY	767383 ▲ FL-02300	767399 ■ FL-21000
	FALL	NATURALE	767392 ▲ FL-02000	767408 ■ FL-17200	
		HIGH-GLOSSY	767384 ▲ FL-02300	767400 ■ FL-21000	

**Per un effetto ottimale della posa, Florim suggerisce di mantenere 2 mm di fuga per pose monoformato e 3 mm per combinare formati misti** - For optimal installation results, Florim recommends maintaining a joint of 2 mm 1/12" for single format installations and 3 mm 1/8" to combine mixed formats. - Pour réaliser une pose parfait, Florim conseille de laisser 2 mm de joint pour la pose des monoformats et 3 mm pour les combinaisons de formats mixtes. - Um einen optimalen effekt beim verlegen zu erzielen empfiehlt Florim eine 2 mm fugen bei einformatigen verlegungen und 3 mm fugen bei formatkombinationen - Para lograr los maximos resultados en la posa del producto, Florim aconseja 2 mm de junta en aplicaciones monoformato y 3 mm en combinaciones de formatos mixtos

**In relazione alle differenti tecnologie produttive l'accostamento di prodotti con spessori diversi potrebbe presentare delle disomogeneità, se ne sconsiglia pertanto l'abbinamento.** / Due to the different production technologies, contiguous installation of products with different thickness may give a non-homogeneous result. For this reason we do not recommend this option. / Vu que différentes technologies de production sont utilisées avec des épaisseurs différentes, des problèmes d'homogénéité pourraient se présenter, il est donc déconseillé de les poser ensemble. / Wegen unterschiedlicher Produktionstechnologien können die Fliesen mit verschiedenen Materialstärken optische Differenzen aufweisen. Von einem direkten Aneinanderlegen wird deshalb abgeraten. / Dadas las diferentes tecnologías productivas, la combinación de productos de diferentes espesores podría dar lugar a heterogeneidad, por lo que se desaconseja mezclarlas.

PEZZI SPECIALI/SPECIAL TRIMS/PIÈCES SPÉCIALES/FORMSTÜCKE/PIEZAS ESPECIALES

9 mm 3/8" 

	COLOR	SURFACE	4,6x60 1 4/8"x23 3/8"  battiscopa	33x120x3 13"x47 1/4"x1 1/8"  angolo gradino DX pz/box 2	33x120x3 13"x47 1/4"x1 1/8"  gradino pz/box 2	33x120x3 13"x47 1/4"x1 1/8"  angolo gradino SX pz/box 2	
<b>B&amp;W_MARBLE</b>		WHITE	NATURALE	756613 ◆ FL-01600	767430 ▲ FL-31100	767422 ▲ FL-20400	767438 ▲ FL-31100
		HIGH-GLOSSY	756611 ◆ FL-01600	-	-	-	
		BLACK	NATURALE	756614 ◆ FL-01600	767431 ▲ FL-31100	767423 ▲ FL-20400	767439 ▲ FL-31100
		HIGH-GLOSSY	756612 ◆ FL-01600	-	-	-	
		WAVE	NATURALE	767415 ◆ FL-01600	767432 ▲ FL-31100	767424 ▲ FL-20400	767440 ▲ FL-31100
		HIGH-GLOSSY	767409 ◆ FL-01600	-	-	-	
		FRAGMENT	NATURALE	767416 ◆ FL-01600	767433 ▲ FL-31100	767425 ▲ FL-20400	767441 ▲ FL-31100
		HIGH-GLOSSY	767410 ◆ FL-01600	-	-	-	
		BREACH	NATURALE	767417 ◆ FL-01600	767434 ▲ FL-31100	767426 ▲ FL-20400	767442 ▲ FL-31100
		HIGH-GLOSSY	767411 ◆ FL-01600	-	-	-	
		PEBBLE	NATURALE	767418 ◆ FL-01600	767435 ▲ FL-31100	767427 ▲ FL-20400	767443 ▲ FL-31100
		HIGH-GLOSSY	767412 ◆ FL-01600	-	-	-	
		FLOW	NATURALE	767420 ◆ FL-01600	767436 ▲ FL-31100	767428 ▲ FL-20400	767444 ▲ FL-31100
		HIGH-GLOSSY	767413 ◆ FL-01600	-	-	-	
		FALL	NATURALE	767421 ◆ FL-01600	767437 ▲ FL-31100	767429 ▲ FL-20400	767445 ▲ FL-31100
		HIGH-GLOSSY	767414 ◆ FL-01600	-	-	-	

FLORIM OVERSIZE  
**magnUm**

160x320/120x280/120x240/120x120/60x120

Specifica Imballo pag.  
Packaging specifications on page  
Spécifications d'emballage à page  
Verpackungsdetail Seite  
Especificaciones de embalaje a la página  
**194/195**









<b>B&amp;W_MARBLE</b>	scatola - box			pallet		
	pz	mq	kg	box	mq	kg
60x120	2	1,44	28,08	30	43,20	870
60x60	3	1,08	21,06	40	43,20	870
30x60	6	1,08	20,84	40	43,20	860
21x40 modulo listello sfalsato	5	0,42	9,66	40	16,80	420

<b>B&amp;W_MARBLE</b>	scatola - box			pallet		
	pz	ml	kg	box	mq	kg
4,6x60 battiscopa	14	8,40	8,40	-	-	-



# B&W\_MARBLE

PEZZI SPECIALI/SPECIAL TRIMS/PIÈCES SPÉCIALES/FORMSTÜCKE/PIEZAS ESPECIALES

6 mm 1/4" 		COLOR	SURFACE	<b>30x30</b> 11 4/5" x 11 4/5"  mosaico tessere 7,5x7,5 <b>pz/box 11</b>	<b>30x30</b> 11 4/5" x 11 4/5"  muretto tessere 7,5x15 <b>pz/box 11</b>	<b>30x30</b> 11 4/5" x 11 4/5"  mosaico tessere 1,5x3 <b>pz/box 11</b>	<b>4,6x80</b> 1 4/5" x 3 1/2"  battiscopa
<b>B&amp;W_MARBLE</b>		WHITE	NATURALE	751192 ▲ FL-01800	751196 ▲ FL-01800	751200 ▲ FL-02700	751204 ◆ FL-01800
		HIGH-GLOSSY	751194 ▲ FL-02100	751198 ▲ FL-02100	751202 ▲ FL-03100	751206 ◆ FL-01800	
		BLACK	NATURALE	751193 ▲ FL-01800	751197 ▲ FL-01800	751201 ▲ FL-02700	751205 ◆ FL-01800
		HIGH-GLOSSY	751195 ▲ FL-02100	751199 ▲ FL-02100	751203 ▲ FL-03100	751207 ◆ FL-01800	
		BREACH	NATURALE	767454 ▲ FL-01800	767466 ▲ FL-01800	767478 ▲ FL-02700	767490 ◆ FL-01800
		HIGH-GLOSSY	767448 ▲ FL-02100	767460 ▲ FL-02100	767472 ▲ FL-03100	767484 ◆ FL-01800	

6 mm 1/4" ↑↓

COLOR

SURFACE

60x120  
23<sup>5</sup>/<sub>8</sub>"x47<sup>1</sup>/<sub>4</sub>"

B&W\_MARBLE



B&W DECOR

NATURALE

767918  
■ FL-29000





# BUILDTECH/2.0

gres fine porcellanato  
fine porcelain stoneware  
grès cérame fin  
feinsteinzeug-kollektionen  
gres porcelánico fino







## BUILDTECH/2.0

In **Buildtech/2.0** il tema del cemento si accompagna a quello del colore. Coerenza e costanza nella ricerca hanno permesso di sviluppare un approccio intuitivo fatto di interesse e curiosità verso i possibili modi di vivere. Interprete di uno stile essenziale ma sofisticato che si evidenzia nella possibilità di molteplici combinazioni tra effetti e differenti superfici studiate per integrarsi ed essere protagoniste dei progetti più accattivanti.

The theme of cement goes hand in hand with that of colour in **Buildtech/ 2.0**. Consistency and constancy in research are the hallmarks of our intuitive approach made up of interest and curiosity regarding possible ways of living. An exponent of an essential yet sophisticated style featuring a wide array of possible combinations of effects and different surfaces designed to complement and star in eye-catching projects.

Dans **Buildtech/ 2.0** le thème du ciment s'accompagne de celui de la couleur. Une recherche cohérente et constante a permis de développer une approche intuitive faite d'intérêt et de curiosité pour les différents modes de vie possibles. Interprète d'un style à la fois essentiel et sophistiqué révélé par les multiples combinaisons d'effets et les différentes surfaces étudiées pour s'intégrer et être protagonistes des projets les plus séduisants.

In **Buildtech/ 2.0** geht das Thema Zement mit der Farbe einher. Dank einer kohärenten und konstanten Forschungstätigkeit wurde ein intuitiver Ansatz entwickelt, der auf dem Interesse und der Neugierde für mögliche Lebensweisen basiert. Der Interpret eines aufs Wesentliche beschränkte, nichtsdestotrotz jedoch edlen Stils, der durch vielfache Kombinationsmöglichkeiten von Effekten und verschiedenen Oberflächen hervorgehoben wird, welche sich integrieren und die Protagonisten der attraktivsten Projekte sind.

En **Buildtech/ 2.0** el tema del cemento se acompaña con el del color. Coherencia y constancia en la búsqueda han permitido desarrollar un enfoque intuitivo basado en el interés y en la curiosidad por las posibles formas de vivir. Una colección intérprete de un estilo esencial, aunque sofisticado, que se manifiesta en la posibilidad de múltiples combinaciones entre efectos y distintas superficies estudiadas para integrarse y ser protagonistas de los proyectos más atractivos.

# BUILDTECH/2.0

## BUILD\_WHITE TU



## BUILD\_WHITE GG



**R10  
CLASSE B**

DCOF >  
0,42 Wet

**9 mm** 3/8"

**GRES FINE PORCELLANATO**  
FINE PORCELAIN STONEWARE / GRÈS CÉRAME FIN / FEINSTEINZEUG-KOLLEKTIONEN / GRES PORCELÁNICO FINO  
SQUADRATO - SQUARED - EQUARRI - REKTIFIZIERT - ESCUADRADO

BUILDTECH/2.0	COLOR	SURFACE	9 mm 3/8"		
			60x120 23 <sup>5/8"</sup> x47 <sup>1/4"</sup>	60x60 23 <sup>5/8"</sup> x23 <sup>5/8"</sup>	30x60 11 <sup>4/8"</sup> x23 <sup>5/8"</sup>
	BUILD_WHITE TU	NATURALE	748989 ■ FL-09100	749025 ■ FL-05800	749079 ■ FL-04900
	BUILD_WHITE GG	NATURALE	749013 ■ FL-09100	749061 ■ FL-05800	749115 ■ FL-04900

## BUILD\_WHITE CE



CE

**R10  
CLASSE A**  
(naturale CE)

**R9**  
(soft CE)

**R10  
CLASSE B**  
(R+PTV)

**R11  
CLASSE C**  
(strutturato)

DCOF>  
0,42 Wet  
(naturale/soft  
strutturato)

BS EN 16165  
ANNEX C  
>36 wet  
slider 96  
(R+PTV)

9 mm 3/8" ↑↓



**R9  
CLASSE A**  
(naturale)

**R10  
CLASSE B**  
(R+PTV)

DCOF>  
0,42 Wet

BS EN 16165  
ANNEX C  
>36 wet  
slider 96  
(R+PTV)

6 mm 1/4" ↑↓

FLORIM OVERSIZE  
**magnUm**

### GRES FINE PORCELLANATO

FINE PORCELAIN STONEWARE / GRÈS CÉRAMÉ FIN / FEINSTEINZEUG-KOLLEKTIONEN / GRES PORCELÁNICO FINO  
SQUADRATO - SQUARED - EQUARRI - REKTIFIZIERT - ESCUADRADO

9 mm 3/8" ↑↓	COLOR	SURFACE	60x120 23 <sup>5/8"</sup> x47 <sup>1/4"</sup>	80x80 31 <sup>1/2"</sup> x31 <sup>1/2"</sup>	40x80 15 <sup>3/4"</sup> x31 <sup>1/2"</sup>	60x60 23 <sup>5/8"</sup> x23 <sup>5/8"</sup>	30x60 11 <sup>4/8"</sup> x23 <sup>5/8"</sup>
<b>BUILDTECH/2.0</b>	BUILD_WHITE CE	NATURALE	765232 ■ FL-09100	765244 ■ FL-08100	765252 ■ FL-05800	765264 ■ FL-05800	765280 ■ FL-04900
		SOFT	765236 ■ FL-09100	765248 ■ FL-08100	765256 ■ FL-05800	765268 ■ FL-05800	765284 ■ FL-04900
		R+PTV	765240 ■ FL-09100	-	-	765276 ■ FL-05800	765292 ■ FL-04900
		STRUTTURATO	-	-	765260 ■ FL-05800	765272 ■ FL-05800	765288 ■ FL-04900

6 mm 1/4" ↑↓	COLOR	SURFACE	120x240 47 <sup>1/4"</sup> x94 <sup>1/2"</sup>	120x120 47 <sup>1/4"</sup> x47 <sup>1/4"</sup>	60x120 23 <sup>5/8"</sup> x47 <sup>1/4"</sup>
<b>BUILDTECH/2.0</b>	BUILD_WHITE CE	NATURALE	766105 ■ FL-09900	766116 ■ FL-08400	766131 ■ FL-07700
		R+PTV	766110 ■ FL-09900	766121 ■ FL-08400	-



# BUILDTECH/2.0

## BUILD\_BONE TU



## BUILD\_BONE GG



**R10  
CLASSE B**

DCOF>  
0,42 Wet

9 mm 3/8" ↑↓

**GRES FINE PORCELLANATO**  
FINE PORCELAIN STONEWARE / GRÈS CÉRAME FIN / FEINSTEINZEUG-KOLLEKTIONEN / GRES PORCELÁNICO FINO  
SQUADRATO - SQUARED - EQUARRI - REKTIFIZIERT - ESCUADRADO

BUILDTECH/2.0	COLOR	SURFACE	9 mm 3/8" ↑↓		
			60x120 23 <sup>5/8"</sup> x47 <sup>1/4"</sup>	60x60 23 <sup>5/8"</sup> x23 <sup>5/8"</sup>	30x60 11 <sup>4/8"</sup> x23 <sup>5/8"</sup>
	BUILD_BONE TU	NATURALE	748990 ■ FL-09100	749026 ■ FL-05800	749080 ■ FL-04900
	BUILD_BONE GG	NATURALE	749014 ■ FL-09100	749062 ■ FL-05800	749116 ■ FL-04900

## BUILD\_BONE CE



CE

**R10  
CLASSE A**  
(naturale CE)

**R9**  
(soft CE)

**R10  
CLASSE B**  
(R+PTV)

**R11  
CLASSE C**  
(strutturato)

DCOF>  
0,42 Wet  
(naturale/soft  
strutturato)

BS EN 16165  
ANNEX C  
>36 wet  
slider 96  
(R+PTV)

9 mm 3/8" ↑↓



CE

**R9  
CLASSE A**  
(naturale)

**R10  
CLASSE B**  
(R+PTV)

DCOF>  
0,42 Wet

BS EN 16165  
ANNEX C  
>36 wet  
slider 96  
(R+PTV)

6 mm 1/4" ↑↓

FLORIM OVERSIZE  
**magnum**

### GRES FINE PORCELLANATO

FINE PORCELAIN STONEWARE / GRÈS CÉRAME FIN / FEINSTEINZEUG-KOLLEKTIONEN / GRES PORCELÁNICO FINO  
SQUADRATO - SQUARED - EQUARRI - REKTIFIZIERT - ESCUADRADO

9 mm 3/8" ↑↓	COLOR	SURFACE	60x120 23 <sup>5/8"</sup> x47 <sup>1/4"</sup>	80x80 31 <sup>1/2"</sup> x31 <sup>1/2"</sup>	40x80 15 <sup>3/4"</sup> x31 <sup>1/2"</sup>	60x60 23 <sup>5/8"</sup> x23 <sup>5/8"</sup>	30x60 11 <sup>4/8"</sup> x23 <sup>5/8"</sup>
<b>BUILDTECH/2.0</b>	BUILD_BONE CE	NATURALE	765233 ■ FL-09100	765245 ■ FL-08100	765253 ■ FL-05800	765265 ■ FL-05800	765281 ■ FL-04900
		SOFT	765237 ■ FL-09100	765249 ■ FL-08100	765257 ■ FL-05800	765269 ■ FL-05800	765285 ■ FL-04900
		R+PTV	765241 ■ FL-09100	-	-	765277 ■ FL-05800	765293 ■ FL-04900
		STRUTTURATO	-	-	765261 ■ FL-05800	765273 ■ FL-05800	765289 ■ FL-04900

6 mm 1/4" ↑↓	COLOR	SURFACE	120x240 47 <sup>1/4"</sup> x94 <sup>1/2"</sup>	120x120 47 <sup>1/4"</sup> x47 <sup>1/4"</sup>	60x120 23 <sup>5/8"</sup> x47 <sup>1/4"</sup>
<b>BUILDTECH/2.0</b>	BUILD_BONE CE	NATURALE	766107 ■ FL-09900	766118 ■ FL-08400	766133 ■ FL-07700
		R+PTV	766112 ■ FL-09900	766123 ■ FL-08400	-

# BUILDTECH/2.0

## BUILD\_MUD TU



## BUILD\_MUD GG



**R10  
CLASSE B**

DCOF>  
0,42 Wet

**9 mm** 3/8"

**GRES FINE PORCELLANATO**  
FINE PORCELAIN STONEWARE / GRÈS CÉRAME FIN / FEINSTEINZEUG-KOLLEKTIONEN / GRES PORCELÁNICO FINO  
SQUADRATO - SQUARED - EQUARRI - REKTIFIZIERT - ESCUADRADO

BUILDTECH/2.0	COLOR	SURFACE	9 mm 3/8"		
			60x120 23 <sup>5/8"</sup> x47 <sup>1/4"</sup>	60x60 23 <sup>5/8"</sup> x23 <sup>5/8"</sup>	30x60 11 <sup>4/8"</sup> x23 <sup>5/8"</sup>
	BUILD_MUD TU	NATURALE	748993 ■ FL-09100	749029 ■ FL-05800	749083 ■ FL-04900
	BUILD_MUD GG	NATURALE	749017 ■ FL-09100	749065 ■ FL-05800	749119 ■ FL-04900

## BUILD\_MUD CE



**R10  
CLASSE A**  
(naturale CE)

**R9**  
(soft CE)

**R10  
CLASSE B**  
(R+PTV)

**R11  
CLASSE C**  
(strutturato)

DCOF>  
0,42 Wet  
(naturale/soft  
strutturato)

BS EN 16165  
ANNEX C  
>36 wet  
slider 96  
(R+PTV)

9 mm 3/8" ↑↓



**R9  
CLASSE A**  
(naturale)

**R10  
CLASSE B**  
(R+PTV)

DCOF>  
0,42 Wet

BS EN 16165  
ANNEX C  
>36 wet  
slider 96  
(R+PTV)

6 mm 1/4" ↑↓

FLORIM OVERSIZE  
**magnUm**

### GRES FINE PORCELLANATO

FINE PORCELAIN STONEWARE / GRÈS CÉRAME FIN / FEINSTEINZEUG-KOLLEKTIONEN / GRES PORCELÁNICO FINO  
SQUADRATO - SQUARED - EQUARRI - REKTIFIZIERT - ESCUADRADO

9 mm 3/8" ↑↓	COLOR	SURFACE	60x120 23 <sup>5/8"</sup> x47 <sup>1/4"</sup>	80x80 31 <sup>1/2"</sup> x31 <sup>1/2"</sup>	40x80 15 <sup>3/4"</sup> x31 <sup>1/2"</sup>	60x60 23 <sup>5/8"</sup> x23 <sup>5/8"</sup>	30x60 11 <sup>4/8"</sup> x23 <sup>5/8"</sup>
<b>BUILDTECH/2.0</b>	BUILD_MUD CE	NATURALE	765234 ■ FL-09100	765246 ■ FL-08100	765254 ■ FL-05800	765266 ■ FL-05800	765282 ■ FL-04900
		SOFT	765238 ■ FL-09100	765250 ■ FL-08100	765258 ■ FL-05800	765270 ■ FL-05800	765286 ■ FL-04900
		R+PTV	765242 ■ FL-09100	-	-	765278 ■ FL-05800	765294 ■ FL-04900
		STRUTTURATO	-	-	765262 ■ FL-05800	765274 ■ FL-05800	765290 ■ FL-04900
6 mm 1/4" ↑↓	COLOR	SURFACE	120x240 47 <sup>1/4"</sup> x94 <sup>1/2"</sup>	120x120 47 <sup>1/4"</sup> x47 <sup>1/4"</sup>	60x120 23 <sup>5/8"</sup> x47 <sup>1/4"</sup>		
<b>BUILDTECH/2.0</b>	BUILD_MUD CE	NATURALE	766108 ■ FL-09900	766119 ■ FL-08400	766134 ■ FL-07700		
		R+PTV	766113 ■ FL-09900	766124 ■ FL-08400	-		



# BUILDTECH/2.0

## BUILD\_COAL TU

## BUILD\_COAL GG



R10  
CLASSE B



DCOF>  
0,42 Wet

9 mm 3/8" ↑↓

### GRES FINE PORCELLANATO

FINE PORCELAIN STONEWARE / GRÈS CÉRAME FIN / FEINSTEINZEUG-KOLLEKTIONEN / GRES PORCELÁNICO FINO

SQUADRATO - SQUARED - EQUARRI - REKTIFIZIERT - ESCUADRADO

9 mm 3/8" ↑↓		COLOR	SURFACE	60x120 23 <sup>5/8"</sup> x47 <sup>1/4"</sup>	60x60 23 <sup>5/8"</sup> x23 <sup>5/8"</sup>	30x60 11 <sup>4/8"</sup> x23 <sup>5/8"</sup>
BUILDTECH/2.0		BUILD_COAL TU	NATURALE	748994 ■ FL-09100	749030 ■ FL-05800	749084 ■ FL-04900
		BUILD_COAL GG	NATURALE	749018 ■ FL-09100	749066 ■ FL-05800	749120 ■ FL-04900

## BUILD\_COAL CE



CE

**R10  
CLASSE A**  
(naturale CE)

**R9**  
(soft CE)

**R10  
CLASSE B**  
(R+PTV)

**R11  
CLASSE C**  
(strutturato)

DCOF>  
0,42 Wet  
(naturale/soft  
strutturato)

BS EN 16165  
ANNEX C  
>36 wet  
slider 96  
(R+PTV)

9 mm 3/8" ↑



**R9  
CLASSE A**  
(naturale)

**R10  
CLASSE B**  
(R+PTV)

DCOF>  
0,42 Wet

BS EN 16165  
ANNEX C  
>36 wet  
slider 96  
(R+PTV)

6 mm 1/4" ↑

FLORIM OVERSIZE  
**magnUm**











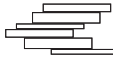

### GRES FINE PORCELLANATO

FINE PORCELAIN STONEWARE / GRÈS CÉRAMÉ FIN / FEINSTEINZEUG-KOLLEKTIONEN / GRES PORCELÁNICO FINO  
SQUADRATO - SQUARED - EQUARRI - REKTIFIZIERT - ESCUADRADO

9 mm 3/8" ↑	COLOR	SURFACE	60x120 23 <sup>5/8"</sup> x47 <sup>1/4"</sup>	80x80 31 <sup>1/2"</sup> x31 <sup>1/2"</sup>	40x80 15 <sup>3/4"</sup> x31 <sup>1/2"</sup>	60x60 23 <sup>5/8"</sup> x23 <sup>5/8"</sup>	30x60 11 <sup>4/5"</sup> x23 <sup>5/8"</sup>
<b>BUILDTECH/2.0</b>	BUILD_COAL CE	NATURALE	765235 ■ FL-09100	765247 ■ FL-08100	765255 ■ FL-05800	765267 ■ FL-05800	765283 ■ FL-04900
		SOFT	765239 ■ FL-09100	765251 ■ FL-08100	765259 ■ FL-05800	765271 ■ FL-05800	765287 ■ FL-04900
		R+PTV	765243 ■ FL-09100	-	-	765279 ■ FL-05800	765295 ■ FL-04900
		STRUTTURATO	-	-	765263 ■ FL-05800	765275 ■ FL-05800	765291 ■ FL-04900

6 mm 1/4" ↑	COLOR	SURFACE	120x240 47 <sup>1/4"</sup> x94 <sup>1/2"</sup>	120x120 47 <sup>1/4"</sup> x47 <sup>1/4"</sup>	60x120 23 <sup>5/8"</sup> x47 <sup>1/4"</sup>
<b>BUILDTECH/2.0</b>	BUILD_COAL CE	NATURALE	766109 ■ FL-09900	766120 ■ FL-08400	766135 ■ FL-07700
		R+PTV	766114 ■ FL-09900	766125 ■ FL-08400	-

# BUILDTECH/2.0

9 mm 3/8" ↑↓				<b>30x30</b> 11 4/5" x 11 4/5"  mosaico tessere 3x3 pz/box 11	<b>21x40</b> 8 1/4" x 15 3/4"  listello sfalsato pz/box 5	<b>30x30</b> 11 4/5" x 11 4/5"  mattoncino tessere 7,5x15 pz/box 11
	COLOR	SURFACE				
	BUILD_WHITE TU	NATURALE	749223 ▲ FL-02000	749187 ▲ FL-01600	749259 ▲ FL-01500	
	BUILD_WHITE GG	NATURALE	749247 ▲ FL-02000	749211 ▲ FL-01600	749283 ▲ FL-01500	
	BUILD_WHITE CE	NATURALE	767494 ▲ FL-02000	767502 ▲ FL-01600	767511 ▲ FL-01500	
		SOFT	767498 ▲ FL-02000	767506 ▲ FL-01600	767515 ▲ FL-01500	
	BUILD_BONE TU	NATURALE	749224 ▲ FL-02000	749188 ▲ FL-01600	749260 ▲ FL-01500	
	BUILD_BONE GG	NATURALE	749248 ▲ FL-02000	749212 ▲ FL-01600	749284 ▲ FL-01500	
	BUILD_BONE CE	NATURALE	767495 ▲ FL-02000	767503 ▲ FL-01600	767512 ▲ FL-01500	
		SOFT	767499 ▲ FL-02000	767508 ▲ FL-01600	767516 ▲ FL-01500	
	BUILD_MUD TU	NATURALE	749227 ▲ FL-02000	749191 ▲ FL-01600	749263 ▲ FL-01500	
	BUILD_MUD GG	NATURALE	749251 ▲ FL-02000	749215 ▲ FL-01600	749287 ▲ FL-01500	
	BUILD_MUD CE	NATURALE	767496 ▲ FL-02000	767504 ▲ FL-01600	767513 ▲ FL-01500	
		SOFT	767500 ▲ FL-02000	767509 ▲ FL-01600	767517 ▲ FL-01500	
	BUILD_COAL TU	NATURALE	749228 ▲ FL-02000	749192 ▲ FL-01600	749264 ▲ FL-01500	
	BUILD_COAL GG	NATURALE	749252 ▲ FL-02000	749216 ▲ FL-01600	749288 ▲ FL-01500	
	BUILD_COAL CE	NATURALE	749497 ▲ FL-02000	767505 ▲ FL-01600	767514 ▲ FL-01500	
		SOFT	767501 ▲ FL-02000	767510 ▲ FL-01600	767518 ▲ FL-01500	

## BUILDTECH/2.0

FLORIM OVERSIZE  
**magnUlm**

**120x240/120x120/60x120**  
 Specifica Imballo pag.  
 Packaging specifications on page  
 Spécifications d'emballage à page  
 Verpackungsdetail Seite  
 Especificaciones de embalaje a la página  
**194/195**















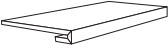
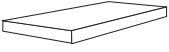

**In relazione alle differenti tecnologie produttive l'accostamento di prodotti con spessori diversi potrebbe presentare delle disomogeneità, se ne sconsiglia pertanto l'abbinamento.** / Due to the different production technologies, contiguous installation of products with different thickness may give a non-homogeneous result. For this reason we do not recommend this option. / Vu que différentes technologies de production sont utilisées avec des épaisseurs différentes, des problèmes d'homogénéité pourraient se présenter, il est donc déconseillé de les poser ensemble. / Wegen unterschiedlicher Produktionstechnologien können die Fliesen mit verschiedenen Materialstärken optische Differenzen aufweisen. Von einem direkten Aneinanderlegen wird deshalb abgeraten. / Dadas las diferentes tecnologías productivas, la combinación de productos de diferentes espesores podría dar lugar a heterogeneidad, por lo que se desaconseja mezclarlas.

**Per un effetto ottimale della posa, Florim suggerisce di mantenere 2 mm di fuga per pose monofornate e 3 mm per combinare formati misti.** - For optimal installation results, Florim recommends maintaining a joint of 2 mm / 1/12" for single format installations and 3 mm / 1/8" to combine mixed formats. - Pour réaliser une pose parfait, Florim conseille de laisser 2 mm de joint pour la pose des monofornats et 3 mm pour les combinaisons de formats mixtes. - Um einen optimalen Effekt beim Verlegen zu erzielen empfiehlt Florim eine 2 mm fugge bei einformatigen Verlegungen und 3 mm fugge bei formatkombinationen. - Para lograr los máximos resultados en la posa del producto, Florim aconseja 2 mm de junta en aplicaciones monofornate y 3 mm en combinaciones de formatos mixtos.







BUILDTECH/2.0	scatola - box			pallet		
	pz	mq	kg	box	mq	kg
60x120	2	1,44	28,08	30	43,20	870
80x80	2	1,28	24,96	40	51,20	1030
40x80	3	0,96	18,53	56	53,76	1070
60x60	3	1,08	21,06	40	43,20	870
30x60	6	1,08	20,84	40	43,20	860

BUILDTECH/2.0	scatola - box			pallet		
	pz	ml	kg	box	mq	kg
4,6x60 battiscopa	14	8,40	8,40	-	-	-

PEZZI SPECIALI/SPECIAL TRIMS/PIÈCES SPÉCIALES/FORMSTÜCKE/PIEZAS ESPECIALES

9 mm 3/8" ↑↓		COLOR	SURFACE	4,6x60 1 4/5"x23 5/8"  battiscopa	33x120x3 13"x47 1/4"x1 1/6"  angolo gradino DX pz/box 2	33x120x3 13"x47 1/4"x1 1/6"  gradino pz/box 2	33x120x3 13"x47 1/4"x1 1/6"  angolo gradino SX pz/box 2
BUILDTECH/2.0		BUILD_WHITE TU	NATURALE	749295 ◆ FL-01600	749385 ▲ FL-31100	749349 ▲ FL-20400	749421 ▲ FL-31100
		BUILD_WHITE GG	NATURALE	749319 ◆ FL-01600	749409 ▲ FL-31100	749373 ▲ FL-20400	749445 ▲ FL-31100
		BUILD_WHITE CE	NATURALE	767519 ◆ FL-01600	767536 ▲ FL-31100	767528 ▲ FL-20400	767544 ▲ FL-31100
			SOFT	767523 ◆ FL-01600	767540 ▲ FL-31100	767532 ▲ FL-20400	767548 ▲ FL-31100
		BUILD_BONE TU	NATURALE	749296 ◆ FL-01600	749386 ▲ FL-31100	749350 ▲ FL-20400	749422 ▲ FL-31100
		BUILD_BONE GG	NATURALE	749320 ◆ FL-01600	749410 ▲ FL-31100	749374 ▲ FL-20400	749446 ▲ FL-31100
		BUILD_BONE CE	NATURALE	767520 ◆ FL-01600	767537 ▲ FL-31100	767529 ▲ FL-20400	767545 ▲ FL-31100
			SOFT	767525 ◆ FL-01600	767541 ▲ FL-31100	767533 ▲ FL-20400	767549 ▲ FL-31100
		BUILD_MUD TU	NATURALE	749299 ◆ FL-01600	749389 ▲ FL-31100	749353 ▲ FL-20400	749425 ▲ FL-31100
		BUILD_MUD GG	NATURALE	749323 ◆ FL-01600	749413 ▲ FL-31100	749377 ▲ FL-20400	749449 ▲ FL-31100
		BUILD_MUD CE	NATURALE	767521 ◆ FL-01600	767538 ▲ FL-31100	767530 ▲ FL-20400	767546 ▲ FL-31100
			SOFT	767526 ◆ FL-01600	767542 ▲ FL-31100	767534 ▲ FL-20400	767550 ▲ FL-31100
		BUILD_COAL TU	NATURALE	749300 ◆ FL-01600	749390 ▲ FL-31100	749354 ▲ FL-20400	749426 ▲ FL-31100
		BUILD_COAL GG	NATURALE	749324 ◆ FL-01600	749414 ▲ FL-31100	749378 ▲ FL-20400	749450 ▲ FL-31100
		BUILD_COAL CE	NATURALE	767522 ◆ FL-01600	767539 ▲ FL-31100	767531 ▲ FL-20400	767547 ▲ FL-31100
			SOFT	767527 ◆ FL-01600	767543 ▲ FL-31100	767535 ▲ FL-20400	767551 ▲ FL-31100

PEZZI SPECIALI/SPECIAL TRIMS/PIÈCES SPÉCIALES/FORMSTÜCKE/PIEZAS ESPECIALES

6 mm 1/4" ↑↓		COLOR	SURFACE	30x30 11 4/5"x11 4/5"  mosaico tessere 7,5x7,5 pz/box 11	30x30 11 4/5"x11 4/5"  muretto tessere 7,5x15 pz/box 11	4,6x60 1 4/5"x23 5/8"  battiscopa
BUILDTECH/2.0		BUILD_WHITE CE	NATURALE	767552 ▲ FL-01800	767556 ▲ FL-01800	767560 ◆ FL-01800
		BUILD_BONE CE	NATURALE	767553 ▲ FL-01800	767557 ▲ FL-01800	767561 ◆ FL-01800
		BUILD_MUD CE	NATURALE	767554 ▲ FL-01800	767558 ▲ FL-01800	767562 ◆ FL-01800
		BUILD_COAL CE	NATURALE	767555 ▲ FL-01800	767559 ▲ FL-01800	767563 ◆ FL-01800



# BUILDTECH/2.0 OUTDOOR

## Vantaggi tecnici - Technical advantages - Avantages techniques Technische Vorteile - Ventajas técnicas

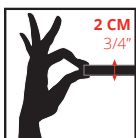

- Lastra monolitica compatta di spessore 2 cm squadrata e rettificata
- Compact monolithic slab 2 cm thick squared and rectified
- Dalle monolithique compacte de 2 cm d'épaisseur, équarrie et rectifiée
- Kompakte monolithische Platte, 2 cm dick, rechteckig und scharfkantig geschliffen
- Losa monolítica compacta de 2 cm de espesor, escuadrada y rectificada.

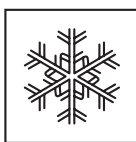

- INGELIVO
- FROST RESISTANT
- INGÉLIF
- FROSTBESTÄNDIG
- RESISTENTE A LA HELADA



- ELEVATA RESISTENZA AI CARICHI STATICI
- HIGH STATIC LOAD RESISTANCE
- RÉSISTANCE ÉLEVÉE AUX CHARGES STATIQUES
- HOHE STATISCHE BELASTBARKEIT
- ELEVADA RESISTENCIA A LAS CARGAS ESTÁTICAS



- FACILE DA POSARE
- EASY TO INSTALL
- FACILE À POSER
- VERLEGELEICHT
- FÁCIL DE COLOCAR



- ANTISCIVOLO R11
- ANTI SLIP R11
- ANTIDÉRAPANT R11
- RUTSCHFEST R11
- ANTIDESLIZANTE R11

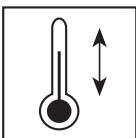

- RESISTENTE AGLI SBALZI TERMICI
- THERMAL SHOCK RESISTANT
- RÉSISTANT AUX ÉCARTS THERMIQUES
- TEMPERATURWECHSELBESTÄNDIG
- RESISTENTE A LAS OSCILACIONES TÉRMICAS



- FACILE DA PULIRE
- EASY TO CLEAN
- FACILE À NETTOYER
- REINIGUNGSLEICHT
- FÁCIL DE LIMPIAR

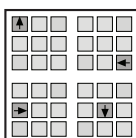

- RIMOVIBILE E RIUTILIZZABILE
- REMOVABLE AND REUSABLE
- DÉMONTABLE ET RÉUTILISABLE
- ENTFERNBAR UND WIEDERVERWENDBAR
- DESMONTABLE Y REUTILIZABLE



- INATTACCABILE DA AGENTI CHIMICI E MUFFE
- IMPERVIOUS TO ATTACK BY CHEMICALS OR MOULD
- RÉSISTANT AUX AGENTS CHIMIQUES ET AUX MOISSISSURES
- UNANGREIFBAR DURCH CHEMISCHE STOFFE UND SCHIMMEL
- RESISTENTE A LOS AGENTES QUÍMICOS Y A LOS MOHOS

## Applicazioni - Applications - Applications - Verlegung - Aplicaciones

- Posa diretta su erba
- Direct installation on grass
- Pose directe sur de l'herbe
- Verlegung direkt auf Rasen
- Colocación directa sobre hierba



- Posa diretta su ghiaia
- Direct installation over gravel
- Pose direct sur du gravier
- Verlegung direkt auf Kies
- Colocación directa sobre grava



- Posa su massetto cementizio
- Installation on sand-cement screed
- Pose sur chape ciment
- Verlegung auf Zement-Unterbetonblock
- Colocación sobre contrapiso de hormigón

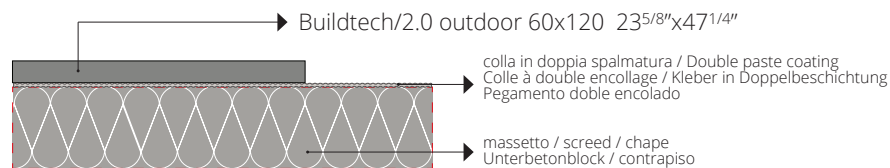

- Posa su piedini fissi o regolabili
- Installation on fixed or adjustable feet
- Pose sur pieds fixes ou réglables
- Verlegung auf feststehende oder regulierbare Füße
- Colocación sobre pies fijos o regulables

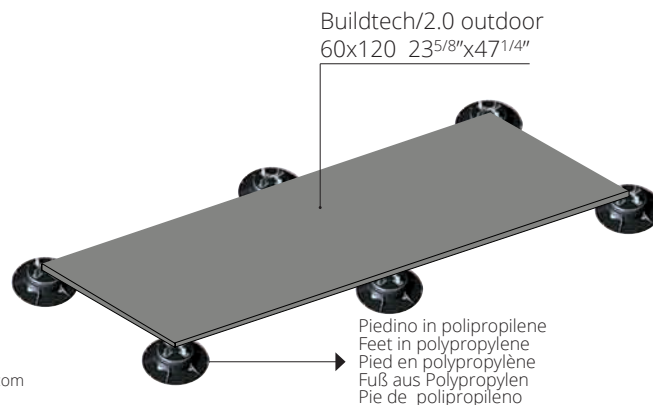

Per le specifiche di utilizzo dei sistemi sopraelevati vedi il sito florim.com  
For the specifics on use of raised systems visit the site florim.com  
Pour les caractéristiques d'utilisation des systèmes surélevés, voir le site florim.com  
Für die Nutzungsbedingungen der Doppelbodensysteme siehe Webseite florim.com  
Para las especificaciones de empleo de los sistemas sobreelevados consulte el sitio web florim.com

Le lastre ceramiche sono sottoposte a un trattamento di compattazione termica che assicura resistenza e durata nel tempo. Il bassissimo assorbimento d'acqua rende perciò il materiale ingelivo. Ciò può comportare ristagni d'acqua superficiali anche per materiale installato a regola d'arte. / Ceramic tiles undergo a compacting thermal treatment that ensures resistance and durability. The low level of water absorption makes the slabs frost resistant. This could result in superficial water stagnations even if materials are installed in a workmanlike manner. / Les carreaux de céramique subissent un traitement thermique de compactage qui assure résistance et durabilité. Le faible niveau d'absorption d'eau rend les dalles résistantes au gel. Il pourrait en résulter des stagnations d'eau superficielles, même si les dalles ont été installées dans les règles de l'art. / Die Keramikplatten werden einer thermischen Verdichtung unterzogen, welche die Widerstandsfähigkeit und Langlebigkeit sichert. Die extrem niedrige Wasseraufnahme macht das Material frostsicher. Die hohe Materialdichte kann, auch bei einer perfekten Verlegung, eine längere Abtrochnungszeit von angestaumtem Wasser zur Folge haben. / Las baldosas cerámicas se someten a un tratamiento de compactación térmica que asegura resistencia y durabilidad. La baja absorción de agua hace que las baldosas resistan al hielo. Esto podría resultar en estancamientos superficiales de agua, incluso si los materiales están instalados según las reglas del arte.

## BUILD\_WHITE CE

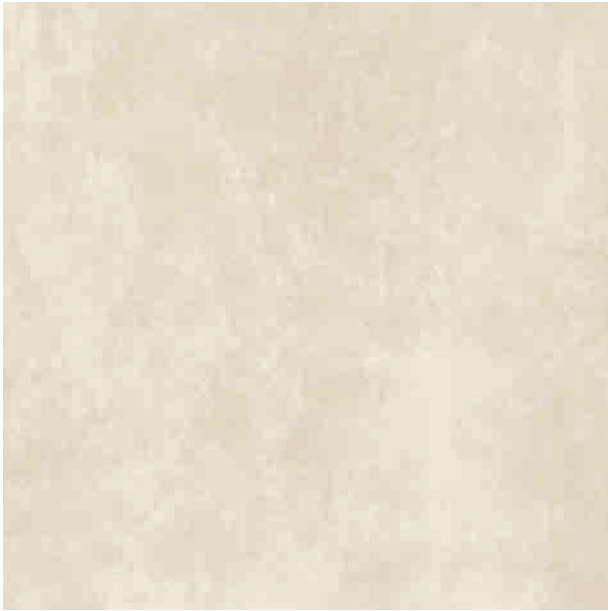

## BUILD\_BONE CE

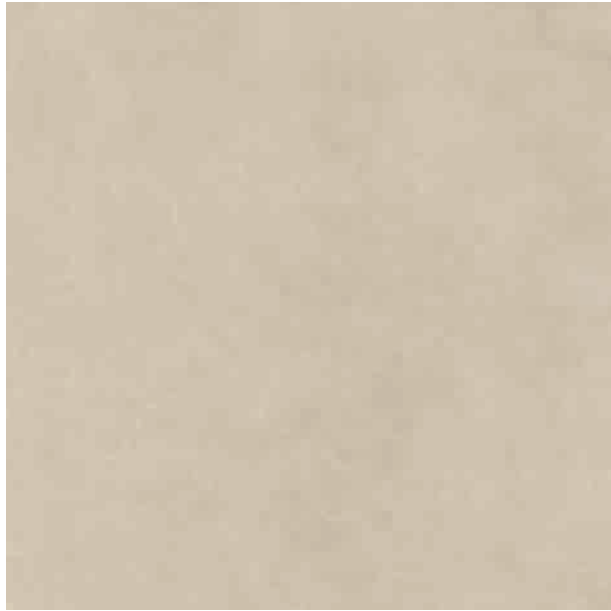

R11  
CLASSE C

20 mm 3/4" ↑↓

## BUILD\_MUD CE



## BUILD\_COAL CE



### GRES FINE PORCELLANATO

FINE PORCELAIN STONEWARE/GRES CERAME FIN/FEINSTEINZEUG-KOLLEKTIONEN/GRES PORCELANICO FINO  
SQUADRATO - SQUARED - EQUARRI - REKTIFIZIERT - ESCUADRADO

20 mm 3/4" ↑↓

	COLOR	SURFACE	60x120 23 <sup>5/8"</sup> x47 <sup>1/4"</sup>
	BUILD_WHITE CE	STRUTTURATO	765296 ■ FL-10300
	BUILD_BONE CE	STRUTTURATO	765297 ■ FL-10300
	BUILD_MUD CE	STRUTTURATO	765298 ■ FL-10300
	BUILD_COAL CE	STRUTTURATO	765299 ■ FL-10300

### BUILDTECH/2.0



20mm  
BUILD\_BONE - BUILD\_MUD - BUILD\_COAL

ISO 10545-4	RESISTENZA ALLA FLESSIONE IN N/mm <sup>2</sup> N/mm <sup>2</sup> FLEXURAL STRENGTH TEST / RESISTANCE A LA FLEXION EN N/mm <sup>2</sup> / BIEGEFESTIGKEIT IN N/mm <sup>2</sup> / RESISTENCIA A LA FLEXION EN N/mm <sup>2</sup>	valore medio 52 N/mm <sup>2</sup>
	Forza di rottura in N (ep. > 7,5 mm) Breaking strength in N (ep. > 7,5 mm) / Force de rupture en N (ep. > 7,5 mm) / Bruchlast in N (Dicke > 7,5 mm) / Fuerza de rotura en N (g. > 7,5 mm)	valore medio 14000 N

BUILDTECH/2.0	scatola - box			pallet		
	pz	mq	kg	box	mq	kg
60x120 20mm	1	0,72	32,26	30	21,60	1000

### PEZZI SPECIALI

Special trims/Pièces spéciales/Formstücke  
Piezas especiales  
pag 184/187



# BUILDTECH/2.0

## CREAM

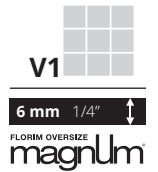
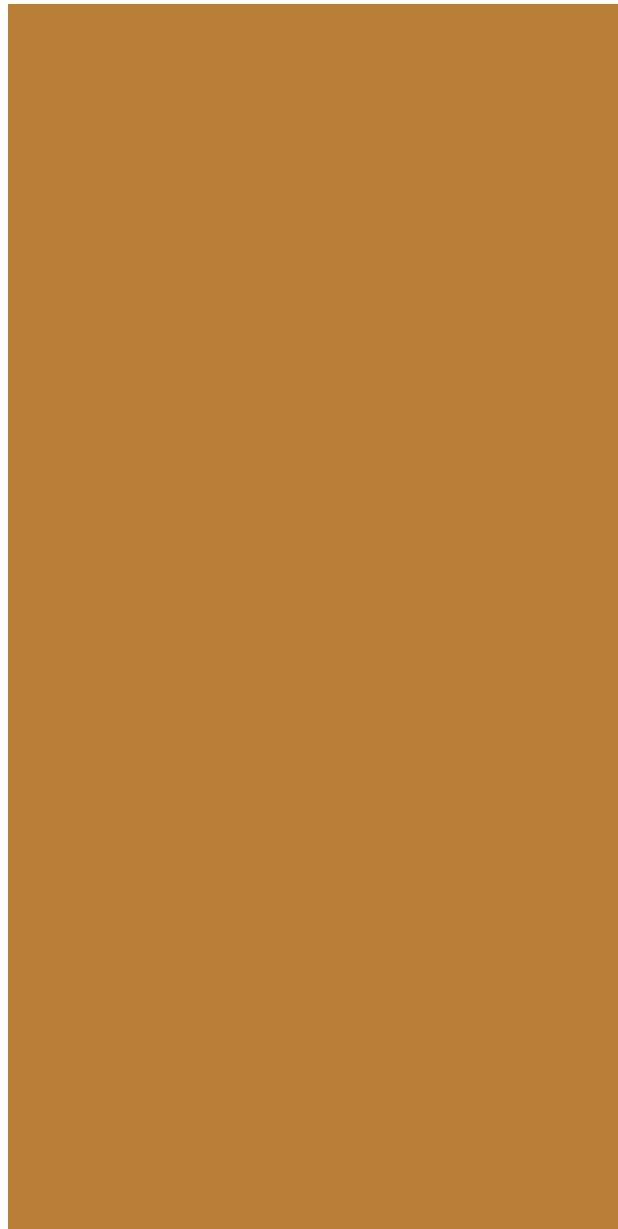
## MUSTARD



**GRES PORCELLANATO DECORATO**  
 DECORATED PORCELAIN TILES/GRÈS CÉRAMÉ DÉCORÉ/VERZIERTES FEINSTEINZEUG/GRES PORCELÁNICO DECORADO  
 SQUADRATO - SQUARED - EQUARRI - REKTIFIZIERT - ESCUADRADO

6 mm 1/4" ↑↓		COLOR	SURFACE	120x280 47 <sup>1/4"</sup> x110 <sup>1/4"</sup>	120x240 47 <sup>1/4"</sup> x94 <sup>1/2"</sup>	120x120 47 <sup>1/4"</sup> x47 <sup>1/4"</sup>	60x120 23 <sup>5/8"</sup> x47 <sup>1/4"</sup>
<b>BUILDTECH/2.0</b>		CREAM	GLOSSY	766859 ■ FL-36500	766674 ■ FL-36500	766879 ■ FL-32200	766900 ■ FL-30000
			NATURALE	766849 ■ FL-27900	766660 ■ FL-27900	766869 ■ FL-25700	766890 ■ FL-23600
		MUSTARD	GLOSSY	766858 ■ FL-36500	766672 ■ FL-36500	766878 ■ FL-32200	766899 ■ FL-30000
			NATURALE	766848 ■ FL-27900	766659 ■ FL-27900	766868 ■ FL-25700	766889 ■ FL-23600

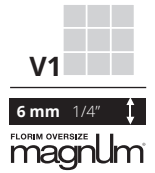

## SCARLET

## CRIMSON



### GRES PORCELLANATO DECORATO

DECORATED PORCELAIN TILES/GRÈS CÉRAMÉ DÉCORÉ/VERZIERTES FEINSTEINZEUG/GRES PORCELÁNICO DECORADO  
SQUADRATO - SQUARED - EQUARRI - REKTIFIZIERT - ESCUADRADO

6 mm 1/4" ↑↓		COLOR	SURFACE	120x280 47 <sup>1/4"</sup> x110 <sup>1/4"</sup>	120x240 47 <sup>1/4"</sup> x94 <sup>1/2"</sup>	120x120 47 <sup>1/4"</sup> x47 <sup>1/4"</sup>	60x120 23 <sup>5/8"</sup> x47 <sup>1/4"</sup>
<b>BUILDTECH/2.0</b>		SCARLET	GLOSSY	766862 ■ FL-36500	766677 ■ FL-36500	766882 ■ FL-32200	766903 ■ FL-30000
			NATURALE	766852 ■ FL-27900	766663 ■ FL-27900	766872 ■ FL-25700	766893 ■ FL-23600
		CRIMSON	GLOSSY	766863 ■ FL-36500	766678 ■ FL-36500	766883 ■ FL-32200	766904 ■ FL-30000
			NATURALE	766853 ■ FL-27900	766665 ■ FL-27900	766873 ■ FL-25700	766894 ■ FL-23600



# BUILDTECH/2.0



## FUCHSIA

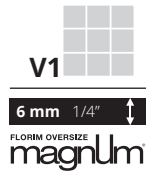

## BURGUNDY



**GRES PORCELLANATO DECORATO**  
 DECORATED PORCELAIN TILES/GRÈS CÉRAMÉ DÉCORÉ/VERZIERTES FEINSTEINZEUG/GRES PORCELÁNICO DECORADO  
 SQUADRATO - SQUARED - EQUARRI - REKTIFIZIERT - ESCUADRADO



6 mm 1/4" ↑↓		COLOR	SURFACE	120x280 47 <sup>1/4"</sup> x110 <sup>1/4"</sup>	120x240 47 <sup>1/4"</sup> x94 <sup>1/2"</sup>	120x120 47 <sup>1/4"</sup> x47 <sup>1/4"</sup>	60x120 23 <sup>5/8"</sup> x47 <sup>1/4"</sup>
<b>BUILDTECH/2.0</b>		FUCHSIA	GLOSSY	766865 ■ FL-36500	766680 ■ FL-36500	766885 ■ FL-32200	766906 ■ FL-30000
			NATURALE	766855 ■ FL-27900	766667 ■ FL-27900	766875 ■ FL-25700	766896 ■ FL-23600
		BURGUNDY	GLOSSY	766864 ■ FL-36500	766679 ■ FL-36500	766884 ■ FL-32200	766905 ■ FL-30000
			NATURALE	766854 ■ FL-27900	766666 ■ FL-27900	766874 ■ FL-25700	766895 ■ FL-23600

## SKY

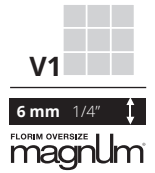
## MIDNIGHT



**GRES PORCELLANATO DECORATO**  
 DECORATED PORCELAIN TILES/GRÈS CÉRAMÉ DÉCORÉ/VERZIERTES FEINSTEINZEUG/GRES PORCELÁNICO DECORADO  
 SQUADRATO - SQUARED - EQUARRI - REKTIFIZIERT - ESCUADRADO

6 mm 1/4" ↑↓		COLOR	SURFACE	120x280 47 <sup>1/4"</sup> x110 <sup>1/4"</sup>	120x240 47 <sup>1/4"</sup> x94 <sup>1/2"</sup>	120x120 47 <sup>1/4"</sup> x47 <sup>1/4"</sup>	60x120 23 <sup>5/8"</sup> x47 <sup>1/4"</sup>
<b>BUILDTECH/2.0</b>		SKY	GLOSSY	766861 ■ FL-36500	766676 ■ FL-36500	766881 ■ FL-32200	766902 ■ FL-30000
			NATURALE	766851 ■ FL-27900	766662 ■ FL-27900	766871 ■ FL-25700	766892 ■ FL-23600
		MIDNIGHT	GLOSSY	766860 ■ FL-36500	766675 ■ FL-36500	766880 ■ FL-32200	766901 ■ FL-30000
			NATURALE	766850 ■ FL-27900	766661 ■ FL-27900	766870 ■ FL-25700	766891 ■ FL-23600

# BUILDTECH/2.0



## TEAL

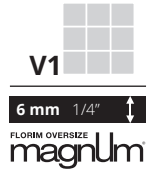

## BOTTLE



**GRES PORCELLANATO DECORATO**  
 DECORATED PORCELAIN TILES/GRÈS CÉRAMÉ DÉCORÉ/VERZIERTES FEINSTEINZEUG/GRES PORCELÁNICO DECORADO  
 SQUADRATO - SQUARED - EQUARRI - REKTIFIZIERT - ESCUADRADO

6 mm 1/4" ↑↓		COLOR	SURFACE	120x280 47 <sup>1/8"</sup> x110 <sup>1/4"</sup>	120x240 47 <sup>1/8"</sup> x94 <sup>1/2"</sup>	120x120 47 <sup>1/8"</sup> x47 <sup>1/8"</sup>	60x120 23 <sup>5/8"</sup> x47 <sup>1/8"</sup>
<b>BUILDTECH/2.0</b>		TEAL	GLOSSY	766856 ■ FL-36500	766668 ■ FL-36500	766876 ■ FL-32200	766897 ■ FL-30000
			NATURALE	766846 ■ FL-27900	766657 ■ FL-27900	766866 ■ FL-25700	766886 ■ FL-23600
		BOTTLE	GLOSSY	766857 ■ FL-36500	766671 ■ FL-36500	766877 ■ FL-32200	766898 ■ FL-30000
			NATURALE	766847 ■ FL-27900	766658 ■ FL-27900	766867 ■ FL-25700	766888 ■ FL-23600

FLORIM OVERSIZE  
**magnUm**

**120x280/120x240/120x120/60x120**  
 Specifica Imballo pag.  
 Packaging specifications on page  
 Spécifications d'emballage à page  
 Verpackungsdetail Seite  
 Especificaciones de embalaje a la página  
**194/195**







# CORETECH

gres fine porcellanato  
fine porcelain stoneware  
grès cérame fin  
feinsteinzeug-kollektionen  
gres porcelánico fino

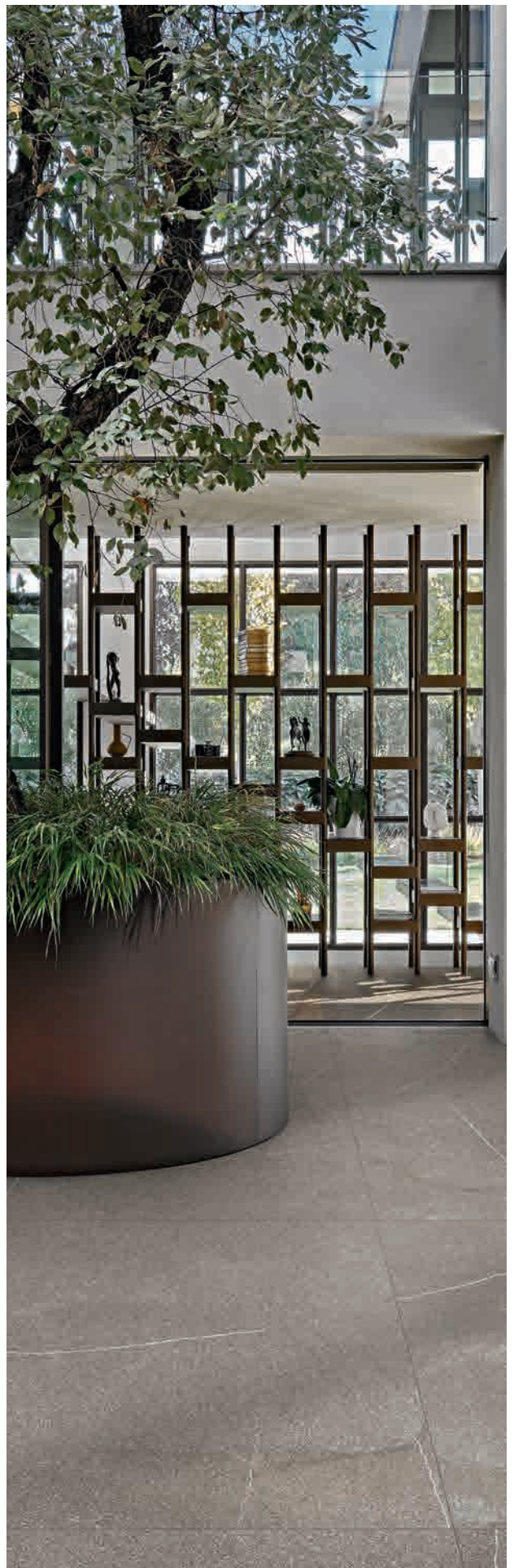





**Questa collezione fa parte del progetto CarbonZero, le superfici Carbon Neutral che compensano tutta la CO<sub>2</sub> emessa durante il loro ciclo di vita.**

*This collection is part of CarbonZero project, Florim's Carbon Neutral surfaces offset all the CO<sub>2</sub> emitted during their lifecycle.*



## CORETECH

**Coretech** è la collezione di Florim che rende la pietra piacentina, estratta nel cuore delle Prealpi Giulie, ancora più performante per le esigenze dell'architettura contemporanea. Ispirata ad un materiale naturalmente bello, resistente, durabile e lavorabile, Coretech si spinge oltre, per assicurare un approccio sostenibile al costruire.

Florim's **Coretech** collection takes Piasentina stone quarried in the foothills of the Julian Alps and enhances its performance to cater to the needs of contemporary architecture. Inspired by a naturally beautiful, tough and workable yet durable material, Coretech takes things to the next level, ensuring a sustainable approach to construction.

**Coretech** est la collection de Florim qui rend la pierre Piasentina, extraite au cœur des Préalpes juliennes, encore plus adaptée aux besoins de l'architecture contemporaine. Inspirée d'un matériau naturellement beau, résistant, durable et facile à travailler, Coretech va encore plus loin afin de garantir une approche durable de la construction.

**Coretech** ist die Kollektion von Florim, mit der Pietra Piasentina, der im Herzen der Julischen Voralpen gewonnen wird, noch mehr Leistungsfähigkeit erhält und somit den Anforderungen der Zeitgenössischen Architektur bestens gerecht wird. Coretech geht, von diesem natürlich schönen, widerstandsfähigen, haltbaren und verarbeitbaren Material inspiriert, noch ein Stück weiter, um der Baubranche einen nachhaltigen Ansatz zu bieten.

**Coretech** es la colección de Florim que logra que la piedra Piasentina, extraída en el corazón de los Prealpes Julianos, ofrezca un mejor rendimiento para las necesidades de la arquitectura contemporánea. La colección Coretech, inspirada en un material hermoso por naturaleza, resistente, duradero y fácil de trabajar, va más allá para garantizar un enfoque sostenible en la construcción.



# CORETECH

## FLAME LIGHT



## BRUSHED LIGHT



**V2**  
**R10**  
 (naturelle)  
**CLASSE B**  
 (naturelle  
 flame light)

**R11**  
 (R11 PTV)

DCOF>  
 0,42 Wet

BS EN 16165  
 ANNEX C  
 >36 wet  
 slider 96  
 (R11 PTV)

9 mm 3/8" ↑↓



**V2**  
**R10**  
 (brushed light  
 naturelle)

**R10**  
**CLASSE B**  
 (flame light  
 naturelle)

DCOF>  
 0,42 Wet

6 mm 1/4" ↑↓

FLOHM OVERSIZE  
**magnum**

**GRES FINE PORCELLANATO**  
 FINE PORCELAIN STONEWARE / GRÈS CÉRAME FIN / FEINSTEINZEUG-KOLLEKTIONEN / GRES PORCELÁNICO FINO  
 SQUADRATO - SQUARED - EQUARRI - REKTIFIZIERT - ESCUADRADO

9 mm 3/8" ↑↓		COLOR	SURFACE	120x120 47 1/4" x 47 1/4"	80x180 31 1/2" x 70 5/8"	60x120 23 5/8" x 47 1/4"	60x60 23 5/8" x 23 5/8"	
<b>CORETECH</b>		FLAME LIGHT	NATURALE/MATTE	-	778943 ■ FL-09870	778947 ■ FL-09100	779227 ■ FL-05800	
			R11 PTV	779553 ■ FL-06650	-	779555 ■ FL-09100	-	
			CANNETÉ	-	-	778953 ■ FL-09500	-	
		BRUSHED LIGHT	NATURALE/MATTE	-	778944 ■ FL-11200	778948 ■ FL-10500	779228 ■ FL-07300	
6 mm 1/4" ↑↓		COLOR	SURFACE	120x280 47 1/4" x 94 1/2"	120x240 47 1/4" x 94 1/2"	120x120 47 1/4" x 47 1/4"	60x120 23 5/8" x 47 1/4"	
<b>CORETECH</b>		FLAME LIGHT	NATURALE/MATTE	778907 ■ FL-10800	778911 ■ FL-09900	778915 ■ FL-08400	778919 ■ FL-07700	
		BRUSHED LIGHT	NATURALE/MATTE	778908 ■ FL-13400	778912 ■ FL-12400	778916 ■ FL-10800	778920 ■ FL-10300	

## SATIN DARK



## FLAME DARK



**R10**  
(naturale)  
**CLASSE B**  
(naturale  
flame dark)

**R9**  
(soft)

**R11**  
(R11 PTV)

DCOF>  
0,42 Wet

BS EN 16165  
ANNEX C  
>36 wet  
slider 96  
(R11 PTV)

9 mm 3/8" ↑↓



**R10**  
(naturale)  
**CLASSE B**  
(naturale  
flame dark)





**R9**  
(soft)

DCOF>  
0,42 Wet

6 mm 1/4" ↑↓

FLORIM OVERSIZE  
**magnlum**





**GRES FINE PORCELLANATO**  
FINE PORCELAIN STONEWARE / GRÈS CÉRAMÉ FIN / FEINSTEINZEUG-KOLLEKTIONEN / GRES PORCELÁNICO FINO  
SQUADRATO - SQUARED - EQUARRI - REKTIFIZIERT - ESCUADRADO

9 mm 3/8" ↑↓		COLOR	SURFACE	120x120 47 <sup>1/4"</sup> x47 <sup>1/4"</sup>	80x180 31 <sup>1/2"</sup> x70 <sup>5/7"</sup>	60x120 23 <sup>5/8"</sup> x47 <sup>1/4"</sup>	60x60 23 <sup>5/8"</sup> x23 <sup>5/8"</sup>
CORETECH		SATIN DARK	SOFT	-	778941 ■ FL-11200	778945 ■ FL-10500	779225 ■ FL-07300
		FLAME DARK	NATURALE/MATTE	-	778942 ■ FL-09870	778946 ■ FL-09100	779226 ■ FL-05800
			R11 PTV	779552 ■ FL-06650	-	779554 ■ FL-09100	-
6 mm 1/4" ↑↓		COLOR	SURFACE	120x280 47 <sup>1/4"</sup> x94 <sup>1/2"</sup>	120x240 47 <sup>1/4"</sup> x94 <sup>1/2"</sup>	120x120 47 <sup>1/4"</sup> x47 <sup>1/4"</sup>	60x120 23 <sup>5/8"</sup> x47 <sup>1/4"</sup>
CORETECH		SATIN DARK	SOFT	778905 ■ FL-13400	778909 ■ FL-12400	778913 ■ FL-10800	778917 ■ FL-10300
		FLAME DARK	NATURALE/MATTE	778906 ■ FL-10800	778910 ■ FL-09900	778914 ■ FL-08400	778918 ■ FL-07700

# CORETECH

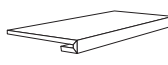
PEZZI SPECIALI/SPECIAL TRIMS/PIÈCES SPÉCIALES/FORMSTÜCKE/PIEZAS ESPECIALES

9 mm 3/8" 

	COLOR	SURFACE	4,6x120 1 47/50" x 4 7 1/4"	33x120x3 1 3" x 4 7 1/4" x 1 1/16"	
			 battiscopa	 gradino pz/box 2	
<b>CORETECH</b>		FLAME LIGHT	NATURALE/MATTE	779586 ◆ FL-01600	779049 ▲ FL-20400
		BRUSHED LIGHT	NATURALE/MATTE	779585 ◆ FL-01600	779047 ▲ FL-20400
		SATIN DARK	SOFT	779588 ◆ FL-01600	779050 ▲ FL-20400
		FLAME DARK	NATURALE/MATTE	779587 ◆ FL-01600	779048 ▲ FL-20400

FLORIM OVERSIZE  
**magnUm**

**120x280/120x240/120x120/60x120**  
 Specifica Imballo pag.  
 Packaging specifications on page  
 Spécifications d'emballage à page  
 Verpackungsdetail Seite  
 Especificaciones de embalaje a la página  
**194/195**

Per un effetto ottimale della posa, Florim suggerisce di mantenere 2 mm di fuga per pose monoformato e 3 mm per combinare formati misti - For optimal installation results, Florim recommends maintaining a joint of 2 mm 1/12" for single format installations and 3 mm 1/8" to combine mixed formats. - Pour réaliser une pose parfait, Florim conseille de laisser 2 mm de joint pour la pose des monoformats et 3 mm pour les combinaisons de formats mixtes. - Um einen optimalen effekt beim verlegen zu erzielen empfiehlt Florim eine 2 mm fugе bei einformatigen verlegungen und 3 mm fugе bei formatkombinationen - Para lograr los máximos resultados en la posa del producto, Florim aconseja 2 mm de junta en aplicaciones monoformato y 3 mm en combinaciones de formatos mixtos.

CORETECH	scatola - box			pallet		
	pz	mq	kg	box	mq	kg
80x180	2	2,88	59,33	20	57,60	1240
60x120	2	1,44	28,08	30	43,20	870
60x60	3	1,08	21,06	40	43,20	870

CORETECH	scatola - box			pallet		
	pz	ml	kg	box	mq	kg
4,6x120 battiscopa	6	7,20	7,20	-	-	-





# CORETECH OUTDOOR

## Vantaggi tecnici - Technical advantages - Avantages techniques Technische Vorteile - Ventajas técnicas

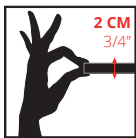

- Lastra monolitica compatta di spessore 2 cm squadrata e rettificata
- Compact monolithic slab 2 cm thick squared and rectified
- Dalle monolithique compacte de 2 cm d'épaisseur, égarrie et rectifiée
- Kompakte monolithische Platte, 2 cm dick, rechteckig und scharfkantig geschliffen
- Losa monolítica compacta de 2 cm de espesor, escuadrada y rectificada.

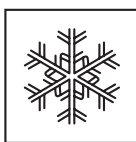

- INGELIVO
- FROST RESISTANT
- INGÉLIF
- FROSTBESTÄNDIG
- RESISTENTE A LA HELADA



- ELEVATA RESISTENZA AI CARICHI STATICI
- HIGH STATIC LOAD RESISTANCE
- RÉSISTANCE ÉLEVÉE AUX CHARGES STATIQUES
- HOHE STATISCHE BELASTBARKEIT
- ELEVADA RESISTENCIA A LAS CARGAS ESTÁTICAS



- FACILE DA POSARE
- EASY TO INSTALL
- FACILE À POSER
- VERLEGELEICHT
- FÁCIL DE COLOCAR



- ANTISCIVOLO R11
- ANTI SLIP R11
- ANTIDÉRAPANT R11
- RUTSCHFEST R11
- ANTIDESLIZANTE R11

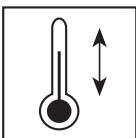

- RESISTENTE AGLI SBALZI TERMICI
- THERMAL SHOCK RESISTANT
- RÉSISTANT AUX ÉCARTS THERMIQUES
- TEMPERATURWECHSELBESTÄNDIG
- RESISTENTE A LAS OSCILACIONES TÉRMICAS



- FACILE DA PULIRE
- EASY TO CLEAN
- FACILE À NETTOYER
- REINIGUNGSLEICHT
- FÁCIL DE LIMPIAR

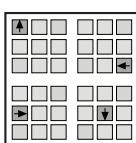

- RIMOVIBILE E RIUTILIZZABILE
- REMOVABLE AND REUSABLE
- DÉMONTABLE ET RÉUTILISABLE
- ENTFERNBAR UND WIEDERVERWENDBAR
- DESMONTABLE Y REUTILIZABLE



- INATTACCABILE DA AGENTI CHIMICI E MUFFE
- IMPERVIUS TO ATTACK BY CHEMICALS OR MOULD
- RÉSISTANT AUX AGENTS CHIMIQUES ET AUX MOISSISSURES
- UNANGREIFBAR DURCH CHEMISCHE STOFFE UND SCHIMMEL
- RESISTENTE A LOS AGENTES QUÍMICOS Y A LOS MOHOS

## Applicazioni - Applications - Applications - Verlegung - Aplicaciones

- Posa diretta su erba
- Direct installation on grass
- Pose directe sur de l'herbe
- Verlegung direkt auf Rasen
- Colocación directa sobre hierba



- Posa diretta su ghiaia
- Direct installation over gravel
- Pose direct sur du gravier
- Verlegung direkt auf Kies
- Colocación directa sobre grava



- Posa su massetto cementizio
- Installation on sand-cement screed
- Pose sur chape ciment
- Verlegung auf Zement-Unterbetonblock
- Colocación sobre contrapiso de hormigón

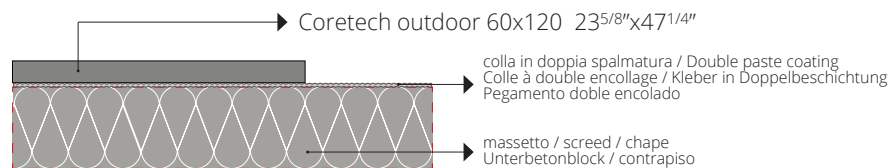

- Posa su piedini fissi o regolabili
- Installation on fixed or adjustable feet
- Pose sur pieds fixes ou réglables
- Verlegung auf feststehende oder regulierbare Füße
- Colocación sobre pies fijos o regulables

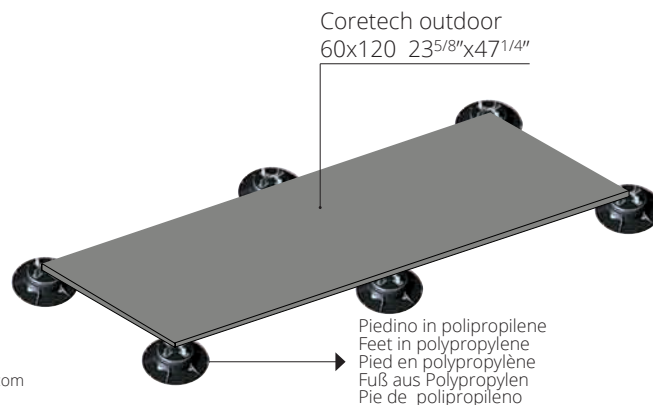

Per le specifiche di utilizzo dei sistemi sopraelevati vedi il sito florim.com  
For the specifics on use of raised systems visit the site florim.com  
Pour les caractéristiques d'utilisation des systèmes surélevés, voir le site florim.com  
Für die Nutzungsbedingungen der Doppelbodensysteme siehe Webseite florim.com  
Para las especificaciones de empleo de los sistemas sobreelevados consulte el sitio web florim.com

Le lastre ceramiche sono sottoposte a un trattamento di compattazione termica che assicura resistenza e durata nel tempo. Il bassissimo assorbimento d'acqua rende perciò il materiale ingelivo. Ciò può comportare ristagni d'acqua superficiali anche per materiale installato a regola d'arte. / Ceramic tiles undergo a compacting thermal treatment that ensures resistance and durability. The low level of water absorption makes the slabs frost resistant. This could result in superficial water stagnations even if materials are installed in a workmanlike manner. / Les carreaux de céramique subissent un traitement thermique de compactage qui assure résistance et durabilité. Le faible niveau d'absorption d'eau rend les dalles résistantes au gel. Il pourrait en résulter des stagnations d'eau superficielles, même si les dalles ont été installées dans les règles de l'art. / Die Keramikplatten werden einer thermischen Verdichtung unterzogen, welche die Widerstandsfähigkeit und Langlebigkeit sichert. Die extrem niedrige Wasseraufnahme macht das Material frostsicher. Die hohe Materialdichte kann, auch bei einer perfekten Verlegung, eine längere Abtrochnungszeit von angestaumtem Wasser zur Folge haben. / Las baldosas cerámicas se someten a un tratamiento de compactación térmica que asegura resistencia y durabilidad. La baja absorción de agua hace que las baldosas resistan al hielo. Esto podría resultar en estancamientos superficiales de agua, incluso si los materiales están instalados según las reglas del arte.

## FLAME LIGHT



V2

R11  
CLASSE C

20 mm 3/4" ↑↓

### GRES FINE PORCELLANATO

FINE PORCELAIN STONEWARE/GRES CERAME FIN/FEINSTEINZEUG-KOLLEKTIONEN/GRES PORCELANICO FINO  
SQUADRATO - SQUARED - EQUARRI - REKTIFIZIERT - ESCUADRADO

20 mm 3/4" ↑↓	COLOR	SURFACE	60x120 23 <sup>5/8"</sup> x47 <sup>1/4"</sup>
---------------	-------	---------	--

CORETECH		FLAME LIGHT	STRUTTURATO	778955 ■ FL-10300
----------	--	-------------	-------------	----------------------

	<b>RESISTENZA ALLA FLESSIONE IN N/mm<sup>2</sup></b> N/mm <sup>2</sup> FLEXURAL STRENGTH TEST / RESISTANCE A LA FLEXION EN N/mm <sup>2</sup> / BIEGEFESTIGKEIT IN N/mm <sup>2</sup> / RESISTENCIA A LA FLEXION EN N/mm <sup>2</sup>	<b>valore medio</b> 52 N/mm <sup>2</sup>
	Forza di rottura in N (sp. > 7,5 mm) Breaking strength in N (sp. > 7,5 mm) / Force de rupture en N (sp. > 7,5 mm) / Bruchlast in N (Dicke > 7,5 mm) / Fuerza de rotura en N (sp. > 7,5 mm)	<b>valore medio</b> 14000 N

### PEZZI SPECIALI

Special trims/Pièces spéciales/Formstücke  
Piezas especiales  
pag 184/187

CORETECH	scatola - box			pallet		
	pz	mq	kg	box	mq	kg
60x120 20mm	1	0,72	32,26	30	21,60	1000

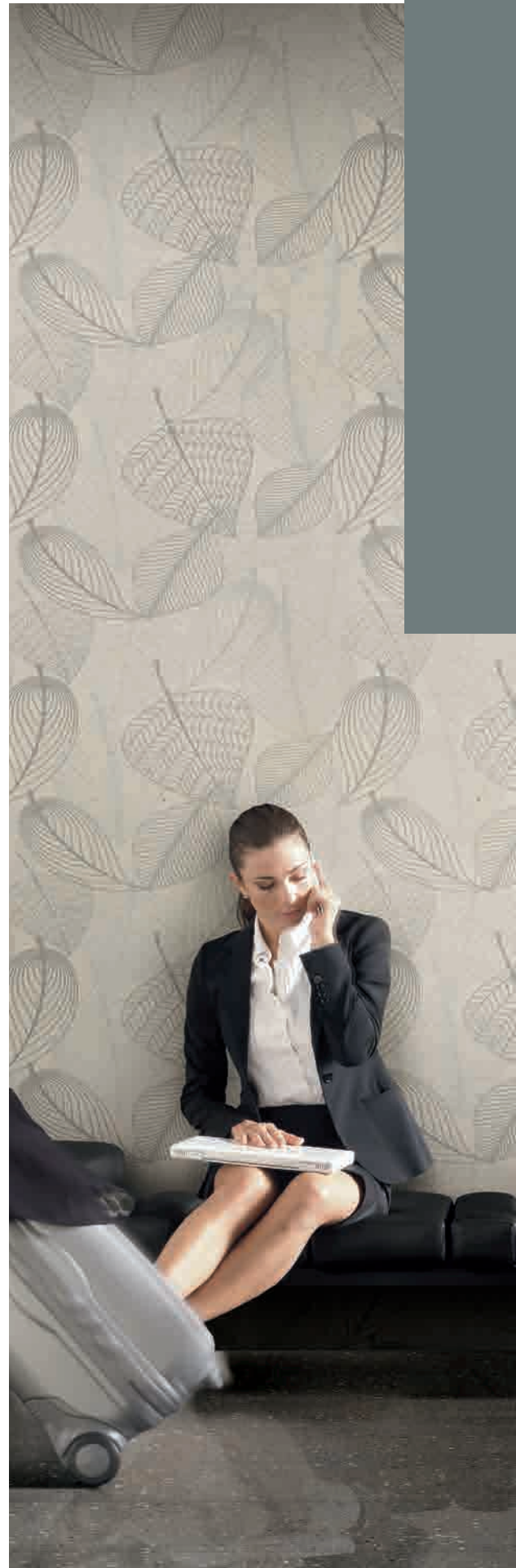



# EARTHTECH

gres fine porcellanato  
fine porcelain stoneware  
grès cérame fin  
feinsteinzeug-kollektionen  
gres porcelánico fino

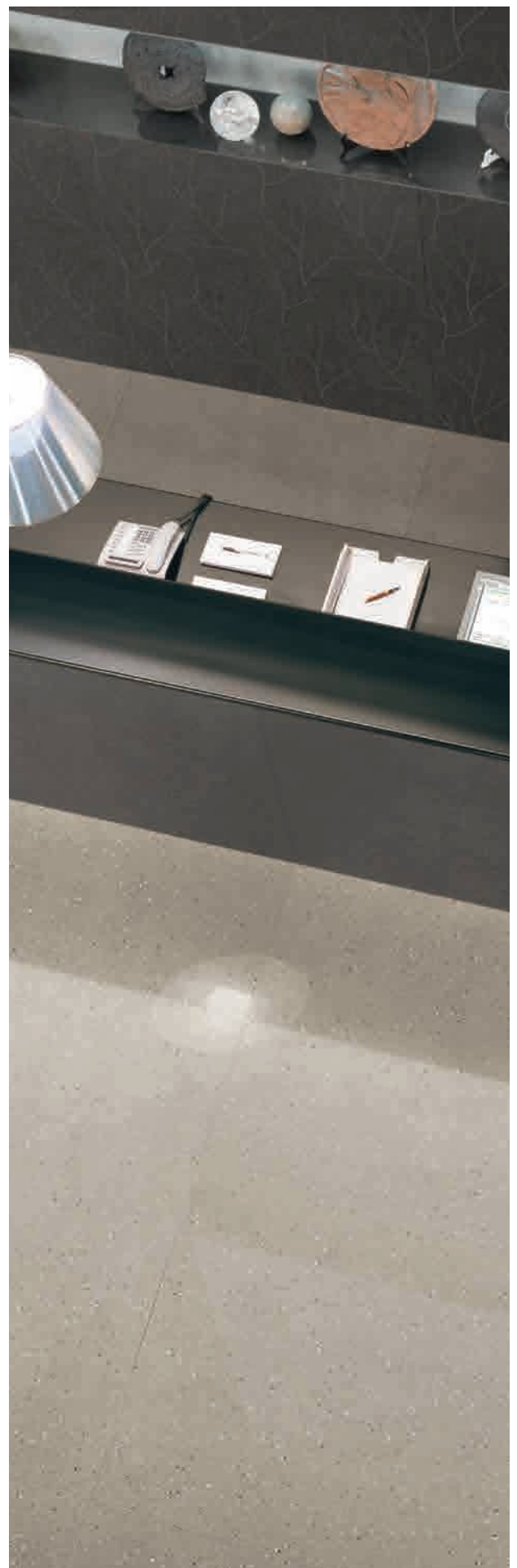





## EARTHTECH

Terra e tecnologia sono divenuti un binomio sempre più reale, portatore di una nuova consapevolezza che parte dalla nostra storia per creare un futuro responsabile. **Earthtech** è la sintesi di una mentalità contemporanea, capace di essere soggetto attivo nelle regole della costruzione circolare. Un prodotto tecnico tutta massa che amalgama insieme superficie e spessore, nato dalla miscelazione spontanea di piccoli frammenti e pigmenti di diversi colori. **Sei cromie** essenziali in accordo con le sfumature degli elementi naturali caratterizzano questa serie che propone tonalità facilmente abbinabili tra loro. **Ground e Flakes** sono le due famiglie estetiche in cui si sviluppa la collezione attraverso una palette cromatica neutra e due colori intensi, giallo e arancione. Nuove finiture, comfort e glossy-bright, ne arricchiscono le possibilità di utilizzo.

Earth and technology have increasingly become a truly dual concept, bearer of a new awareness coming from our past to create a responsible future. **Earthtech** is the synthesis of a contemporary mindset, capable of being an active player within the rules of circular construction. It is a full-bodied technical product which mixes together surface and thickness, born from the spontaneous blending of small fragments and pigments of different colours. **Six essential hues** in harmony with shades of natural elements are the distinguishing features of this series which offers easily matchable tones. **Ground and Flakes** are the two aesthetic families in which the collection develops, through a neutral colour palette and two intense colours, yellow and orange. New finishes, Comfort and Glossy bright enhance their potential uses.

La terre et la technologie forment désormais un binôme de plus en plus concret, porteur d'une nouvelle prise de conscience qui part de notre histoire pour créer un futur responsable. **Earthtech** est la synthèse d'une mentalité moderne, à même de jouer un rôle actif dans les règles de la construction circulaire. Un produit technique pleine masse qui amalgame surface et épaisseur, né du mélange spontané de petits fragments et pigments de diverses couleurs. **Six colorations** essentielles en accord avec les nuances des éléments naturels caractérisent cette série qui propose des teintes pouvant facilement être combinées. **Ground et flakes** sont les deux familles esthétiques au sein desquelles se développe la collection à travers une palette chromatique neutre et deux couleurs intenses, le jaune et l'orange. De nouvelles finitions, Comfort et Glossy bright, enrichissent les possibilités d'utilisation.

Erde und Technologie wurden zu einer immer reelleren Kombination, zum Träger eines neuen Bewusstseins, das unsere Geschichte als Ausgangspunkt für die Schaffung einer verantwortungsbewussten Zukunft nimmt. **Earthtech** ergibt sich aus einer zeitgenössischen Mentalität, die bei den Regeln zur Kreislaufbauwirtschaft eine aktive Rolle spielt. Ein ganzscherbiges technisches Produkt, das Oberfläche und Masse vermischt und aus der spontanen Mischung kleiner Fragmente und verschiedenfarbiger Pigmente entsteht. **Sechs Farben** widerspiegeln die Nuancen der Naturelemente und zeichnen diese Serie mit ihren untereinander leicht kombinierbaren Farbtönen aus. **Ground und Flakes** sind zwei ästhetische Varianten, in denen sich die Kollektion durch eine neutrale Farbpalette und zwei intensive Farben, gelb und orange, entwickelt. Neue Oberflächen, Comfort und Glossy-Bright, vervielfältigen ihre Einsatzmöglichkeiten.

La tierra y la tecnología se han convertido en un binomio cada vez más real, portador de una nueva sensibilidad que echa raíces en nuestra historia para crear un futuro responsable. **Earthtech** es la síntesis de una forma de pensar contemporánea, capaz de participar activamente en la economía circular del sector de la construcción. Un producto técnico toda masa que conjuga superficie y grosor, fruto de la mezcla espontánea de pequeños fragmentos y pigmentos de varios colores. **Seis colores** básicos, acordes con los matices cromáticos de los elementos naturales, componen esta serie caracterizada por tonalidades fáciles de combinar entre sí. **Ground y flakes** son las dos familias estéticas en las que se articula la colección, por medio de una paleta cromática neutra y dos colores intensos: el amarillo y el naranja. Se enriquece con los nuevos acabados Comfort y Glossy-bright, que amplían sus posibilidades de uso.

## PUMICE\_GROUND



## PUMICE\_FLAKES



**R10**  
**Classe B**  
(comfort)

DCOF>  
0,60 Wet  
(comfort)

BS EN 16165  
ANNEX C  
>36 wet  
slider 96  
(comfort)

**9 mm** 3/8" ↑↓

**R10**  
**Classe B**



DCOF>  
0,60 Wet

BS EN 16165  
ANNEX C  
>36 wet  
slider 96  
(comfort)

**6 mm** 1/4" ↑↓

FLOHM OVERSIZE  
**magnum**

**GRES FINE PORCELLANATO**  
FINE PORCELAIN STONEWARE / GRÈS CÉRAME FIN / FEINSTEINZEUG-KOLLEKTIONEN / GRES PORCELÁNICO FINO  
SQUADRATO - SQUARED - EQUARRI - REKTIFIZIERT - ESCUADRADO

<b>9 mm</b> 3/8" ↑↓		COLOR	SURFACE	<b>120x240</b> 47 <sup>1/4"</sup> x94 <sup>1/2"</sup>	<b>120x120</b> 47 <sup>1/4"</sup> x47 <sup>1/4"</sup>	<b>60x120</b> 23 <sup>5/8"</sup> x47 <sup>1/4"</sup>	<b>60x60*</b> 23 <sup>5/8"</sup> x23 <sup>5/8"</sup>
<b>EARTHTECH</b>		PUMICE_GROUND	COMFORT	-	777189 ■ FL-10300	776958 ■ FL-09100	776977 ■ FL-08100
		PUMICE_FLAKES	COMFORT	776929 ■ FL-12400	776941 ■ FL-10300	776960 ■ FL-09100	776979 ■ FL-08100
			GLOSSY-BRIGHT	776923 ■ FL-15100	776935 ■ FL-12400	776947 ■ FL-10500	776967 ■ FL-09400
<b>6 mm</b> 1/4" ↑↓		COLOR	SURFACE	<b>120x280</b> 47 <sup>1/4"</sup> x110 <sup>1/4"</sup>	<b>120x240</b> 47 <sup>1/4"</sup> x94 <sup>1/2"</sup>	<b>120x120</b> 47 <sup>1/4"</sup> x47 <sup>1/4"</sup>	<b>60x120</b> 23 <sup>5/8"</sup> x47 <sup>1/4"</sup>
<b>EARTHTECH</b>		PUMICE_GROUND	COMFORT	771449 ■ FL-10800	771459 ■ FL-09900	771607 ■ FL-08400	771631 ■ FL-07700

**60x60\***

only upon request for orders > 1.000 sqm  
uniquement sur demande pour les commandes > 1.000 m<sup>2</sup>  
nur auf Anfrage für Bestellungen > 1.000 m<sup>2</sup>  
solo a petición para pedidos > 1.000 m<sup>2</sup>

## DESERT\_GROUND



## DESERT\_FLAKES



**R10**  
**Classe B**  
(comfort)

DCOF>  
0,60 Wet  
(comfort)

BS EN 16165  
ANNEX C  
>36 wet  
slider 96  
(comfort)

9 mm 3/8" ↑↓

**R10**  
**Classe B**

DCOF>  
0,60 Wet

BS EN 16165  
ANNEX C  
>36 wet  
slider 96  
(comfort)

6 mm 1/4" ↑↓

FLORIM OVERSIZE  
**magnum**

**GRES FINE PORCELLANATO**  
FINE PORCELAIN STONEWARE / GRÈS CÉRAME FIN / FEINSTEINZEUG-KOLLEKTIONEN / GRES PORCELÁNICO FINO  
SQUADRATO - SQUARED - EQUARRI - REKTIFIZIERT - ESCUADRADO

9 mm 3/8" ↑↓		COLOR	SURFACE	120x240 47 <sup>1/4"</sup> x94 <sup>1/2"</sup>	120x120 47 <sup>1/4"</sup> x47 <sup>1/4"</sup>	60x120 23 <sup>5/8"</sup> x47 <sup>1/4"</sup>	60x60* 23 <sup>5/8"</sup> x23 <sup>5/8"</sup>
<b>EARTHTECH</b>	DESERT_GROUND	COMFORT	-	777184 ■ FL-10300	776953 ■ FL-09100	776972 ■ FL-08100	
	DESERT_FLAKES	COMFORT	776932 ■ FL-12400	776944 ■ FL-10300	776963 ■ FL-09100	776982 ■ FL-08100	
		GLOSSY-BRIGHT	776926 ■ FL-15100	776938 ■ FL-12400	776951 ■ FL-10500	776970 ■ FL-09400	
6 mm 1/4" ↑↓		COLOR	SURFACE	120x280 47 <sup>1/4"</sup> x110 <sup>1/4"</sup>	120x240 47 <sup>1/4"</sup> x94 <sup>1/2"</sup>	120x120 47 <sup>1/4"</sup> x47 <sup>1/4"</sup>	60x120 23 <sup>5/8"</sup> x47 <sup>1/4"</sup>
<b>EARTHTECH</b>	DESERT_GROUND	COMFORT		771450 ■ FL-10800	771462 ■ FL-09900	771626 ■ FL-08400	771632 ■ FL-07700



## FOG\_GROUND



## FOG\_FLAKES

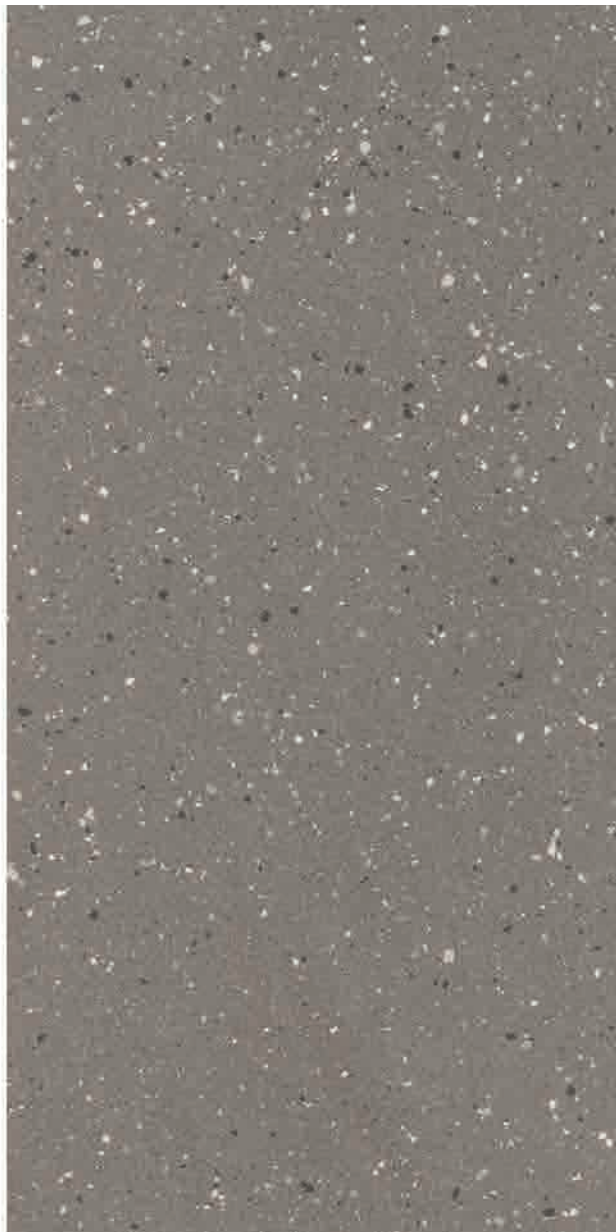

**R10**  
**Classe B**  
(comfort)

DCOF>  
0,60 Wet  
(comfort)

BS EN 16165  
ANNEX C  
>36 wet  
slider 96  
(comfort)

**9 mm** 3/8" ↑↓

**R10**  
**Classe B**



DCOF>  
0,60 Wet

BS EN 16165  
ANNEX C  
>36 wet  
slider 96  
(comfort)

**6 mm** 1/4" ↑↓

FLOHM OVERSIZE  
**magnum**

**GRES FINE PORCELLANATO**  
FINE PORCELAIN STONEWARE / GRÈS CÉRAME FIN / FEINSTEINZEUG-KOLLEKTIONEN / GRES PORCELÁNICO FINO  
SQUADRATO - SQUARED - EQUARRI - REKTIFIZIERT - ESCUADRADO

<b>9 mm</b> 3/8" ↑↓		COLOR	SURFACE	<b>120x240</b> 47 <sup>1/4"</sup> x94 <sup>1/2"</sup>	<b>120x120</b> 47 <sup>1/4"</sup> x47 <sup>1/4"</sup>	<b>60x120</b> 23 <sup>5/8"</sup> x47 <sup>1/4"</sup>	<b>60x60*</b> 23 <sup>5/8"</sup> x23 <sup>5/8"</sup>
<b>EARTHTECH</b>		FOG_GROUND	COMFORT	-	777185 ■ FL-10300	776954 ■ FL-09100	776973 ■ FL-08100
		FOG_FLAKES	COMFORT	776931 ■ FL-12400	776943 ■ FL-10300	776962 ■ FL-09100	776981 ■ FL-08100
			GLOSSY-BRIGHT	776925 ■ FL-15100	776937 ■ FL-12400	776949 ■ FL-10500	776969 ■ FL-09400
<b>6 mm</b> 1/4" ↑↓		COLOR	SURFACE	<b>120x280</b> 47 <sup>1/4"</sup> x110 <sup>1/4"</sup>	<b>120x240</b> 47 <sup>1/4"</sup> x94 <sup>1/2"</sup>	<b>120x120</b> 47 <sup>1/4"</sup> x47 <sup>1/4"</sup>	<b>60x120</b> 23 <sup>5/8"</sup> x47 <sup>1/4"</sup>
<b>EARTHTECH</b>		FOG_GROUND	COMFORT	771451 ■ FL-10800	771463 ■ FL-09900	771627 ■ FL-08400	771633 ■ FL-07700

**60x60\***

solo su richiesta per ordini >1.000 mq  
only upon request for orders > 1.000 sqm  
uniquement sur demande pour les commandes >1.000 m<sup>2</sup>  
nur auf Anfrage für Bestellungen >1.000 m<sup>2</sup>  
solo a petición para pedidos >1.000 m<sup>2</sup>

## CARBON\_GROUND

## CARBON\_FLAKES

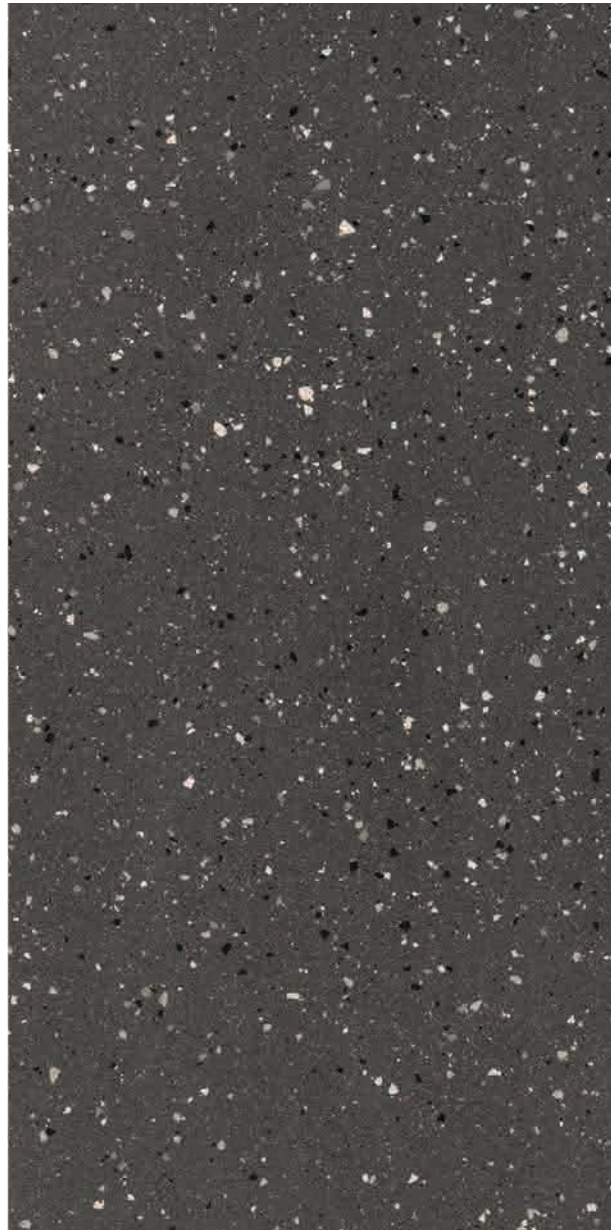

**R10**  
**Classe B**  
(comfort)

DCOF>  
0,60 Wet  
(comfort)

BS EN 16165  
ANNEX C  
>36 wet  
slider 96  
(comfort)

9 mm 3/8" ↑↓

**R10**  
**Classe B**



DCOF>  
0,60 Wet

BS EN 16165  
ANNEX C  
>36 wet  
slider 96  
(comfort)

6 mm 1/4" ↑↓

FLORIM OVERSIZE  
**magnum**

**GRES FINE PORCELLANATO**  
FINE PORCELAIN STONEWARE / GRÈS CÉRAME FIN / FEINSTEINZEUG-KOLLEKTIONEN / GRES PORCELÁNICO FINO  
SQUADRATO - SQUARED - EQUARRI - REKTIFIZIERT - ESCUADRADO

9 mm 3/8" ↑↓		COLOR	SURFACE	120x240 47 <sup>1/4"</sup> x94 <sup>1/2"</sup>	120x120 47 <sup>1/4"</sup> x47 <sup>1/4"</sup>	60x120 23 <sup>5/8"</sup> x47 <sup>1/4"</sup>	60x60* 23 <sup>5/8"</sup> x23 <sup>5/8"</sup>
<b>EARTHTECH</b>		CARBON_GROUND	COMFORT	-	777186 ■ FL-10300	776955 ■ FL-09100	776974 ■ FL-08100
		CARBON_FLAKES	COMFORT	776933 ■ FL-12400	776945 ■ FL-10300	776965 ■ FL-09100	776983 ■ FL-08100
			GLOSSY-BRIGHT	776927 ■ FL-15100	776939 ■ FL-12400	776952 ■ FL-10500	776971 ■ FL-09400
6 mm 1/4" ↑↓		COLOR	SURFACE	120x280 47 <sup>1/4"</sup> x110 <sup>1/4"</sup>	120x240 47 <sup>1/4"</sup> x94 <sup>1/2"</sup>	120x120 47 <sup>1/4"</sup> x47 <sup>1/4"</sup>	60x120 23 <sup>5/8"</sup> x47 <sup>1/4"</sup>
<b>EARTHTECH</b>		CARBON_GROUND	COMFORT	771452 ■ FL-10800	771464 ■ FL-09900	771628 ■ FL-08400	771634 ■ FL-07700

## SAVANNAH\_GROUND



## SAVANNAH\_FLAKES



**R10**  
**Classe B**  
(comfort)

DCOF>  
0,60 Wet  
(comfort)

BS EN 16165  
ANNEX C  
>36 wet  
slider 96  
(comfort)

**9 mm** 3/8" ↑↓

**R10**  
**Classe B**



DCOF>  
0,60 Wet

BS EN 16165  
ANNEX C  
>36 wet  
slider 96  
(comfort)

**6 mm** 1/4" ↑↓

FLOHM OVERSIZE  
**magnum**

**GRES FINE PORCELLANATO**  
FINE PORCELAIN STONEWARE / GRÈS CÉRAME FIN / FEINSTEINZEUG-KOLLEKTIONEN / GRES PORCELÁNICO FINO  
SQUADRATO - SQUARED - EQUARRI - REKTIFIZIERT - ESCUADRADO

<b>9 mm</b> 3/8" ↑↓		COLOR	SURFACE	<b>120x240</b> 47 <sup>1/4"</sup> x94 <sup>1/2"</sup>	<b>120x120</b> 47 <sup>1/4"</sup> x47 <sup>1/4"</sup>	<b>60x120</b> 23 <sup>5/8"</sup> x47 <sup>1/4"</sup>	<b>60x60*</b> 23 <sup>5/8"</sup> x23 <sup>5/8"</sup>
<b>EARTHTECH</b>		SAVANNAH_GROUND	COMFORT	-	777187 ■ FL-10300	776956 ■ FL-09100	776975 ■ FL-08100
		SAVANNAH_FLAKES	COMFORT	776928 ■ FL-12400	776940 ■ FL-10300	776959 ■ FL-09100	776978 ■ FL-08100
			GLOSSY-BRIGHT	776922 ■ FL-15100	776934 ■ FL-12400	776946 ■ FL-10500	776966 ■ FL-09400
<b>6 mm</b> 1/4" ↑↓		COLOR	SURFACE	<b>120x280</b> 47 <sup>1/4"</sup> x110 <sup>1/4"</sup>	<b>120x240</b> 47 <sup>1/4"</sup> x94 <sup>1/2"</sup>	<b>120x120</b> 47 <sup>1/4"</sup> x47 <sup>1/4"</sup>	<b>60x120</b> 23 <sup>5/8"</sup> x47 <sup>1/4"</sup>
<b>EARTHTECH</b>		SAVANNAH_GROUND	COMFORT	771453 ■ FL-10800	771465 ■ FL-09900	771629 ■ FL-08400	771635 ■ FL-07700

**60x60\***

solo su richiesta per ordini >1.000 mq  
only upon request for orders > 1.000 sqm  
uniquement sur demande pour les commandes >1.000 m<sup>2</sup>  
nur auf Anfrage für Bestellungen >1.000 m<sup>2</sup>  
solo a petición para pedidos >1.000 m<sup>2</sup>



## OUTBACK\_GROUND



## OUTBACK\_FLAKES

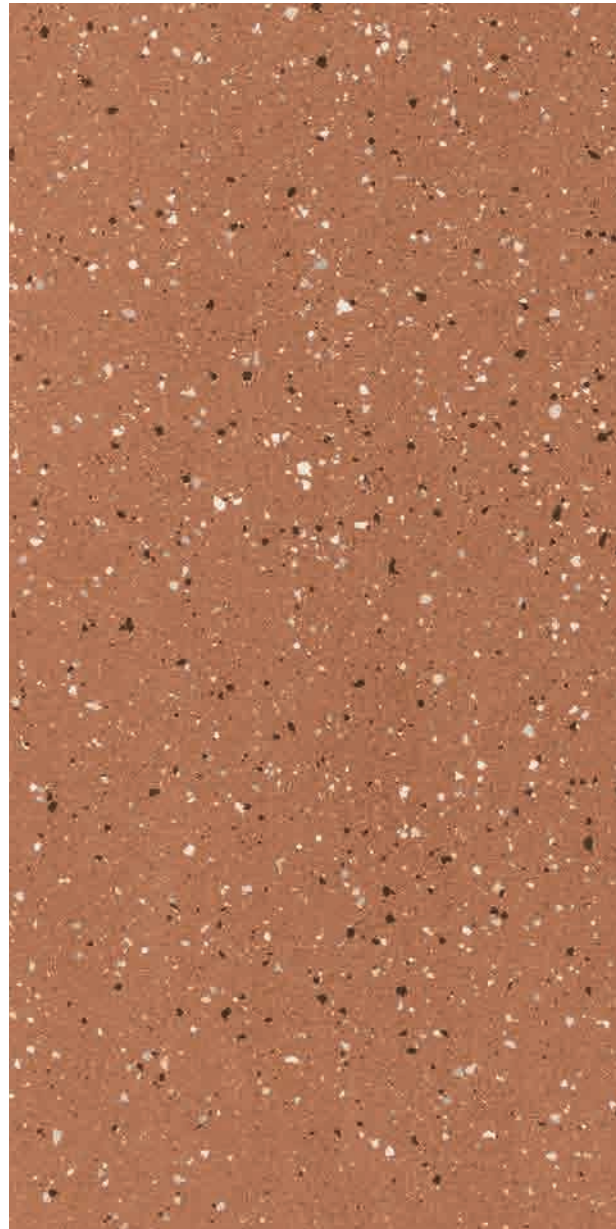

**R10**  
**Classe B**  
(comfort)

DCOF>  
0,60 Wet  
(comfort)

BS EN 16165  
ANNEX C  
>36 wet  
slider 96  
(comfort)

9 mm 3/8" ↑↓

**R10**  
**Classe B**

DCOF>  
0,60 Wet

BS EN 16165  
ANNEX C  
>36 wet  
slider 96  
(comfort)

6 mm 1/4" ↑↓

FLORIM OVERSIZE  
**magnum**

**GRES FINE PORCELLANATO**  
FINE PORCELAIN STONEWARE / GRÈS CÉRAME FIN / FEINSTEINZEUG-KOLLEKTIONEN / GRES PORCELÁNICO FINO  
SQUADRATO - SQUARED - EQUARRI - REKTIFIZIERT - ESCUADRADO

9 mm 3/8" ↑↓	COLOR	SURFACE	120x240 47 <sup>1/4"</sup> x94 <sup>1/2"</sup>	120x120 47 <sup>1/4"</sup> x47 <sup>1/4"</sup>	60x120 23 <sup>5/8"</sup> x47 <sup>1/4"</sup>	60x60* 23 <sup>5/8"</sup> x23 <sup>5/8"</sup>
<b>EARTHTECH</b>	OUTBACK_GROUND	COMFORT	-	777188 ■ FL-10300	776957 ■ FL-09100	776976 ■ FL-08100
		COMFORT	776930 ■ FL-12400	776942 ■ FL-10300	776961 ■ FL-09100	776980 ■ FL-08100
	OUTBACK_FLAKES	COMFORT	776924 ■ FL-15100	776936 ■ FL-12400	776948 ■ FL-10500	776968 ■ FL-09400
		GLOSSY-BRIGHT				
6 mm 1/4" ↑↓	COLOR	SURFACE	120x280 47 <sup>1/4"</sup> x110 <sup>1/4"</sup>	120x240 47 <sup>1/4"</sup> x94 <sup>1/2"</sup>	120x120 47 <sup>1/4"</sup> x47 <sup>1/4"</sup>	60x120 23 <sup>5/8"</sup> x47 <sup>1/4"</sup>
<b>EARTHTECH</b>	OUTBACK_GROUND	COMFORT	771454 ■ FL-10800	771466 ■ FL-09900	771630 ■ FL-08400	771636 ■ FL-07700



## PUMICE

## DESERT

## FOG



Il decoro FRONDS\_A è disponibile a magazzino nel colore CARBON GROUND nei seguenti formati 120x280, 120x240 e 60x120.

The FRONDS\_A décor is available in stock in the colour CARBON GROUND in the sizes 120x280, 120x240 and 60x120. / Le Décor FRONDS\_A est disponible en stock dans la couleur CARBON GROUND dans les formats 120x280, 120x240 e 60x120. / Der Dekor FRONDS\_A ist in der Farbe CARBON GROUND in den folgenden Formaten 120x280, 120x240 und 60x120 als Lagerware bestellbar. / La decoración FRONDS\_A está disponible en stock en el color CARBON GROUND en los siguientes formatos 120x280, 120x240 y 60x120.

### GRES FINE PORCELLANATO

FINE PORCELAIN STONEWARE / GRÈS CÉRAME FIN / FEINSTEINZEUG-KOLLEKTIONEN / GRES PORCELÁNICO FINO  
SQUADRATO - SQUARED - EQUARRI - REKTIFIZIERT - ESCUADRADO

FLORM OVERSIZE  
**magnUm**

6 mm 1/4" ↑↓	COLOR	SURFACE	120x280	120x240	60x120
			47 <sup>11/16"</sup> x 110 <sup>1/4"</sup>	47 <sup>1/4"</sup> x 94 <sup>1/2"</sup>	23 <sup>5/8"</sup> x 47 <sup>1/4"</sup>
EARTHTECH	FRONDS_A_CARBON_GROUND	COMFORT	772725 ■ FL-31100	772731 ■ FL-31100	-
	FRONDS_A_CARBON_GROUND_1	COMFORT	-	-	772737 ■ FL-29000
	FRONDS_A_CARBON_GROUND_2	COMFORT	-	-	772738 ■ FL-29000
	FRONDS_A_CARBON_GROUND_3	COMFORT	-	-	772739 ■ FL-29000
	FRONDS_A_CARBON_GROUND_4	COMFORT	-	-	772740 ■ FL-29000
	FRONDS_A_CARBON_GROUND_1+2+3+4	COMFORT	-	-	9000236 ■ FL-29000

## CARBON

## SAVANNAH

## OUTBACK



## DECORO FRONDS\_A

### GRES FINE PORCELLANATO

FINE PORCELAIN STONEWARE / GRÈS CÉRAMÉ FIN / FEINSTEINZEUG-KOLLEKTIONEN / GRES PORCELÁNICO FINO  
SQUADRATO - SQUARED - EQUARRI - REKTIFIZIERT - ESCUADRADO

6 mm 1/4" ↑↓	COLOR	SURFACE	120x280	120x240	60x120
			47 <sup>1/4"</sup> x110 <sup>1/4"</sup>	47 <sup>1/4"</sup> x94 <sup>1/2"</sup>	23 <sup>5/8"</sup> x47 <sup>1/4"</sup>
	FRONDS_A_GROUND	COMFORT	772726 ■ FL-38600	772732 ■ FL-38600	-
EARTHTECH	FRONDS_A_GROUND_1	COMFORT	-	-	772741 ■ FL-36500
	FRONDS_A_GROUND_2	COMFORT	-	-	772742 ■ FL-36500
	FRONDS_A_GROUND_3	COMFORT	-	-	772743 ■ FL-36500
	FRONDS_A_GROUND_4	COMFORT	-	-	772744 ■ FL-36500
	FRONDS_A_GROUND_1+2+3+4	COMFORT	-	-	9000240 ■ FL-36500

FLORIM OVERSIZE  
magnum

**I restanti colori sono ordinabili su richiesta tramite i codici on demand della tabella a fianco, specificando il colore desiderato.**

The remaining colours can be ordered on request using the "on demand" codes in the opposite table, specifying the desired colour. / Les autres couleurs peuvent être commandées sur demande avec les codes spécifiques du tableau en pièce jointe, en indiquant la couleur souhaitée. / Die restlichen Farben können auf Anfrage unter Verwendung der "On-Demand-Codes" in der nebenstehenden Tabelle unter Angabe der gewünschten Farbe bestellt werden. / El resto de colores se pueden pedir a través de los códigos de la tabla, eligiendo colores y acabados como desee.

## PUMICE

## DESERT

## FOG

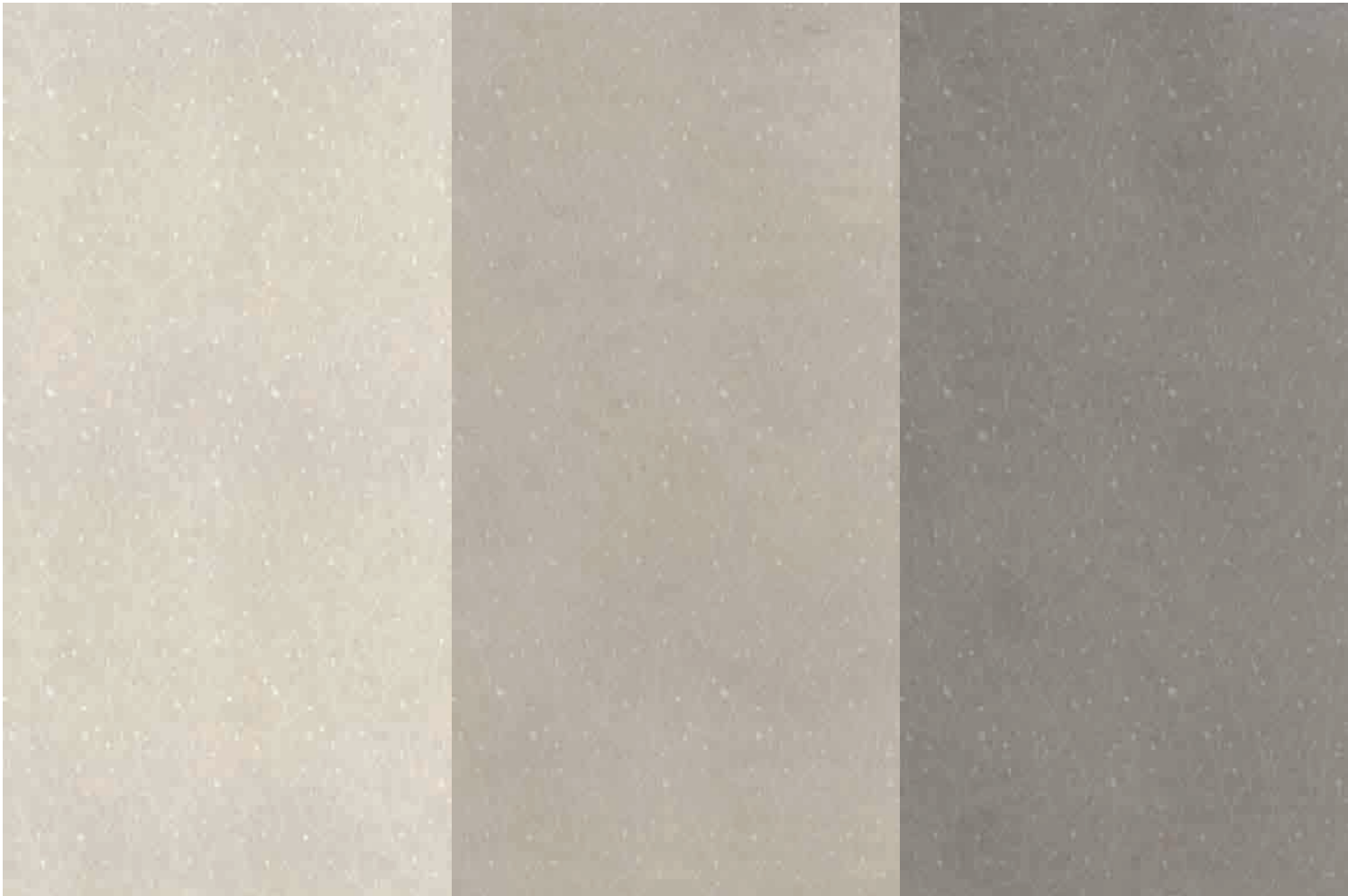

**Il decoro FRONDS\_B è disponibile a magazzino nel colore DESERT GROUND nei seguenti formati 120x280, 120x240 e 60x120.**

The FRONDS\_B décor is available in stock in the colour DESERT GROUND in the sizes 120x280, 120x240 and 60x120. / Le Décor FRONDS\_B est disponible en stock dans la couleur DESERT GROUND dans les formats 120x280, 120x240 e 60x120. / Der Dekor FRONDS\_B ist in der Farbe DESERT GROUND in den folgenden Formaten 120x280, 120x240 und 60x120 als Lagerware bestellbar. / La decoración FRONDS\_B está disponible en stock en el color DESERT GROUND en los siguientes formatos 120x280, 120x240 y 60x120.

### GRES FINE PORCELLANATO

FINE PORCELAIN STONEWARE / GRÈS CÉRAME FIN / FEINSTEINZEUG-KOLLEKTIONEN / GRES PORCELÁNICO FINO  
SQUADRATO - SQUARED - EQUARRI - REKTIFIZIERT - ESCUADRADO

FLORM OVERSIZE  
**magnUm**

6 mm 1/4" ↑↓	COLOR	SURFACE	120x280	120x240	60x120
			47 <sup>11/16"</sup> x 110 <sup>1/4"</sup>	47 <sup>11/16"</sup> x 94 <sup>1/2"</sup>	23 <sup>5/8"</sup> x 47 <sup>11/16"</sup>
<b>EARTHTECH</b>	FRONDS_B_DESERT_GROUND	COMFORT	772727 ■ FL-31100	772733 ■ FL-31100	-
	FRONDS_B_DESERT_GROUND_1	COMFORT	-	-	772745 ■ FL-29000
	FRONDS_B_DESERT_GROUND_2	COMFORT	-	-	772746 ■ FL-29000
	FRONDS_B_DESERT_GROUND_3	COMFORT	-	-	772747 ■ FL-29000
	FRONDS_B_DESERT_GROUND_4	COMFORT	-	-	772748 ■ FL-29000
	FRONDS_B_DESERT_GROUND_1+2+3+4	COMFORT	-	-	9000237 ■ FL-29000

CARBON

SAVANNAH

OUTBACK

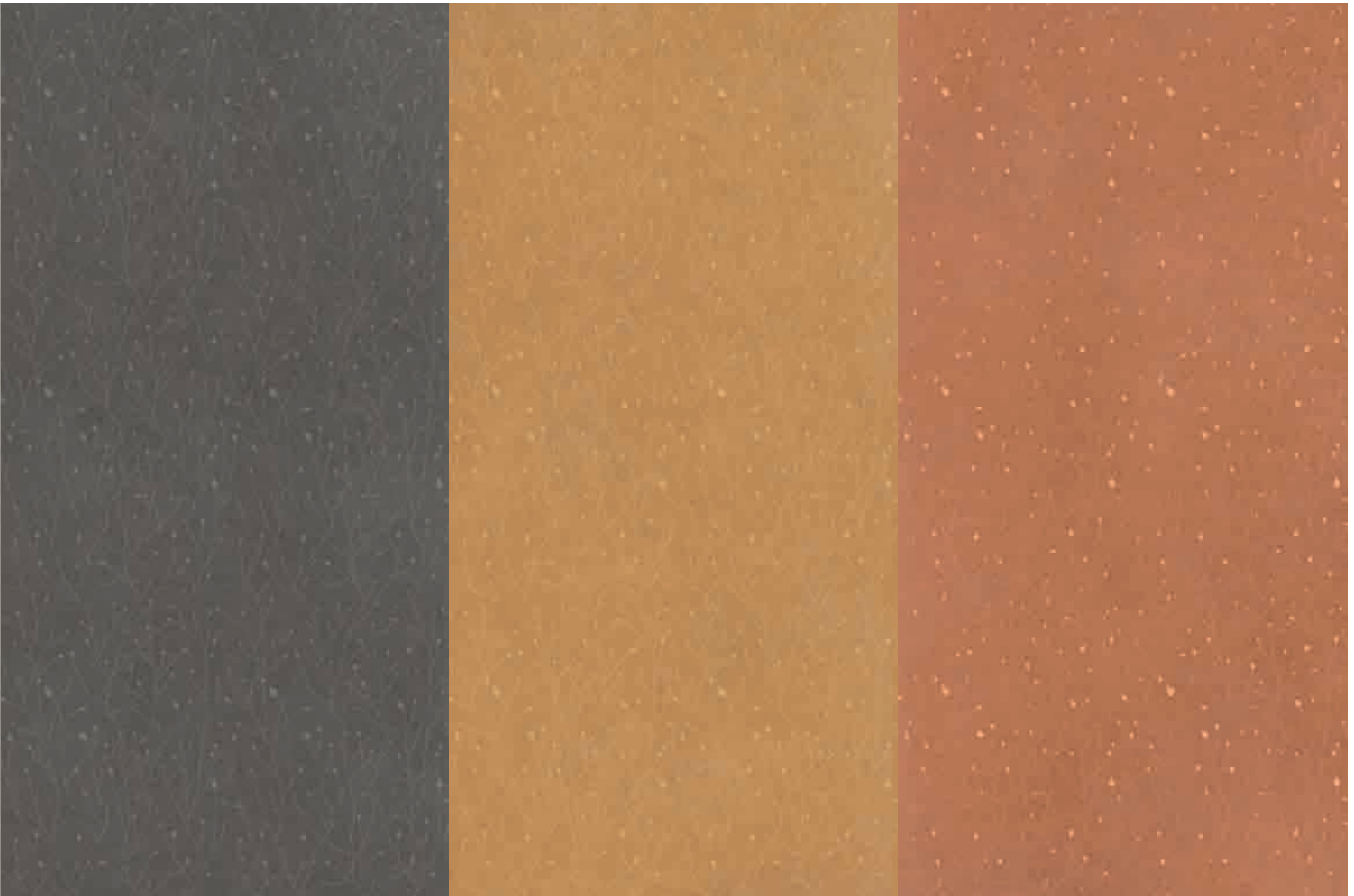

## DECORO FRONDS\_B

### GRES FINE PORCELLANATO

FINE PORCELAIN STONEWARE / GRÈS CÉRAME FIN / FEINSTEINZEUG-KOLLEKTIONEN / GRES PORCELÁNICO FINO  
SQUADRATO - SQUARED - EQUARRI - REKTIFIZIERT - ESCUADRADO

6 mm 1/4" 	COLOR	SURFACE	120x280	120x240	60x120
			47 <sup>1/4"</sup> x110 <sup>1/4"</sup>	47 <sup>1/4"</sup> x94 <sup>1/2"</sup>	23 <sup>5/8"</sup> x47 <sup>1/4"</sup>
EARTHTECH	FRONDS_B_GROUND	COMFORT	772728 ■ FL-38600	772734 ■ FL-38600	-
	FRONDS_B_GROUND_1	COMFORT	-	-	772749 ■ FL-36500
	FRONDS_B_GROUND_2	COMFORT	-	-	772750 ■ FL-36500
	FRONDS_B_GROUND_3	COMFORT	-	-	772751 ■ FL-36500
	FRONDS_B_GROUND_4	COMFORT	-	-	772752 ■ FL-36500
	FRONDS_B_GROUND_1+2+3+4	COMFORT	-	-	9000241 ■ FL-36500

FLORIM OVERSIZE  
**magnum**

**I restanti colori sono ordinabili su richiesta tramite i codici on demand della tabella a fianco, specificando il colore desiderato.**

The remaining colours can be ordered on request using the "on demand" codes in the opposite table, specifying the desired colour. / Les autres couleurs peuvent être commandées sur demande avec les codes spécifiques du tableau en pièce jointe, en indiquant la couleur souhaitée. / Die restlichen Farben können auf Anfrage unter Verwendung der "On-Demand-Codes" in der nebenstehenden Tabelle unter Angabe der gewünschten Farbe bestellt werden. / El resto de colores se pueden pedir a través de los códigos de la tabla, eligiendo colores y acabados como desea.



## PUMICE

## DESERT

## FOG



Il decoro LEAVES è disponibile a magazzino nel colore PUMICE GROUND nei seguenti formati 120x280, 120x240 e 60x120.

The LEAVES décor is available in stock in the colour PUMICE GROUND in the sizes 120x280, 120x240 and 60x120. / Le Décor LEAVES est disponible en stock dans la couleur PUMICE GROUND dans les formats 120x280, 120x240 e 60x120. / Der Dekor LEAVES ist in der Farbe PUMICE GROUND in den folgenden Formaten 120x280, 120x240 und 60x120 als Lagerware bestellbar. / La decoración LEAVES está disponible en stock en el color PUMICE GROUND en los siguientes formatos 120x280, 120x240 y 60x120.

### GRES FINE PORCELLANATO

FINE PORCELAIN STONEWARE / GRÈS CÉRAME FIN / FEINSTEINZEUG-KOLLEKTIONEN / GRES PORCELÁNICO FINO  
SQUADRATO - SQUARED - EQUARRI - REKTIFIZIERT - ESCUADRADO

FLORIM OVERSIZE  
**magnUm**

6 mm 1/4" ↑↓	COLOR	SURFACE	120x280	120x240	60x120
			47 <sup>11/16"</sup> x 110 <sup>1/4"</sup>	47 <sup>1/4"</sup> x 94 <sup>1/2"</sup>	23 <sup>5/8"</sup> x 47 <sup>1/4"</sup>
EARTHTECH	LEAVES_PUMICE_GROUND	COMFORT	772729 ■ FL-31100	772735 ■ FL-31100	-
	LEAVES_PUMICE_GROUND_1	COMFORT	-	-	772753 ■ FL-30000
	LEAVES_PUMICE_GROUND_2	COMFORT	-	-	772754 ■ FL-30000
	LEAVES_PUMICE_GROUND_3	COMFORT	-	-	772755 ■ FL-30000
	LEAVES_PUMICE_GROUND_4	COMFORT	-	-	772756 ■ FL-30000
	LEAVES_PUMICE_GROUND_1+2+3+4	COMFORT	-	-	9000238 ■ FL-30000

CARBON

SAVANNAH

OUTBACK

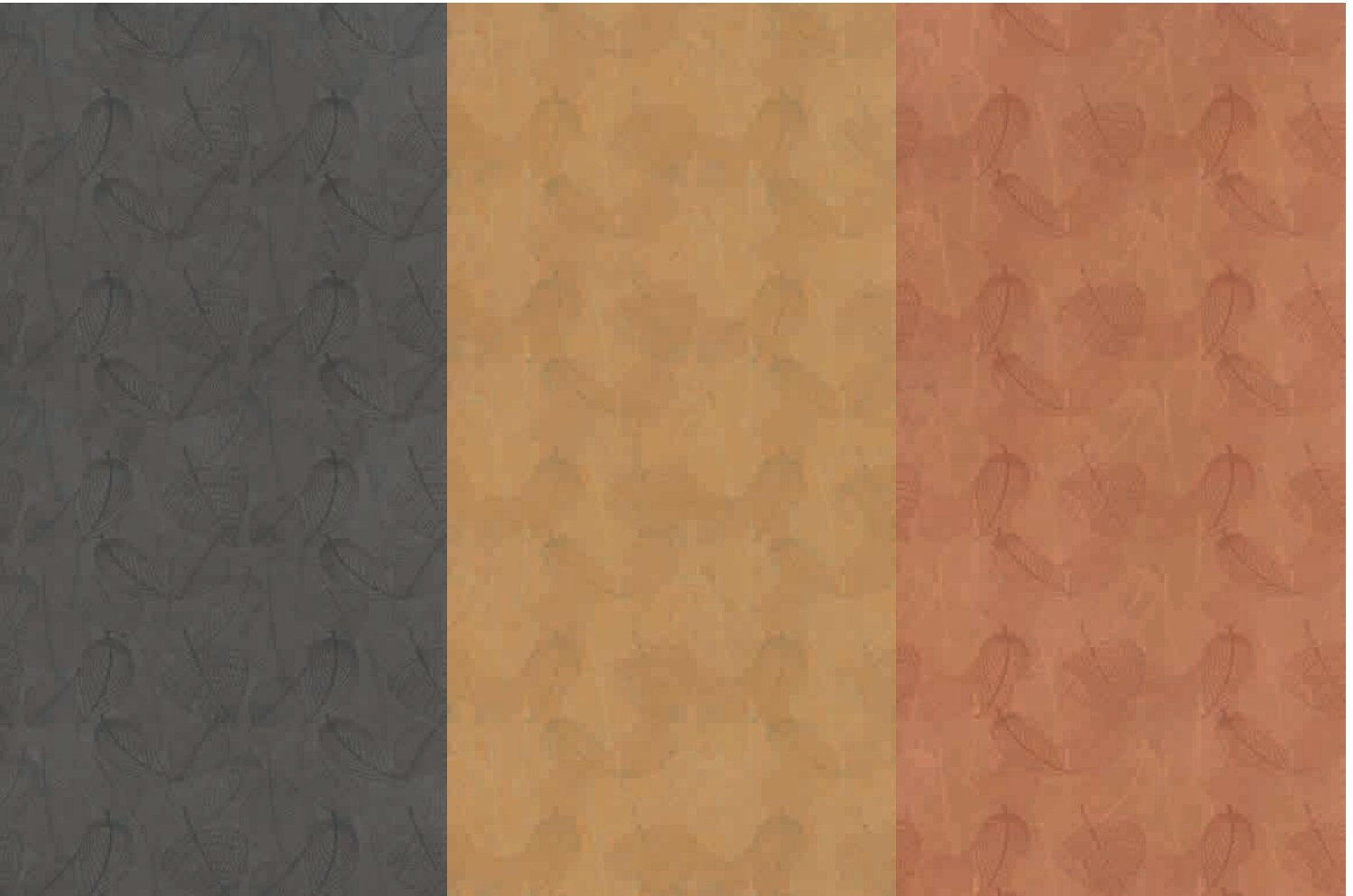

## DECORO LEAVES

### GRES FINE PORCELLANATO

FINE PORCELAIN STONEWARE / GRÈS CÉRAME FIN / FEINSTEINZEUG-KOLLEKTIONEN / GRES PORCELÁNICO FINO  
SQUADRATO - SQUARED - EQUARRI - REKTIFIZIERT - ESCUADRADO

6 mm 1/4" ↑↓	COLOR	SURFACE	120x280	120x240	60x120
			47 <sup>1/4"</sup> x110 <sup>1/4"</sup>	47 <sup>1/4"</sup> x94 <sup>1/2"</sup>	23 <sup>5/8"</sup> x47 <sup>1/4"</sup>
EARTHTECH	LEAVES_GROUND	COMFORT	772730 ■ FL-49300	772736 ■ FL-49300	-
	LEAVES_GROUND_1	COMFORT	-	-	772757 ■ FL-47100
	LEAVES_GROUND_2	COMFORT	-	-	772758 ■ FL-47100
	LEAVES_GROUND_3	COMFORT	-	-	772759 ■ FL-47100
	LEAVES_GROUND_4	COMFORT	-	-	772760 ■ FL-47100
	LEAVES_GROUND_1+2+3+4	COMFORT	-	-	9000242 ■ FL-47100

FLOIRM OVERSIZE  
magnum

**I restanti colori sono ordinabili su richiesta tramite i codici on demand della tabella a fianco, specificando il colore desiderato.**

The remaining colours can be ordered on request using the "on demand" codes in the opposite table, specifying the desired colour. / Les autres couleurs peuvent être commandées sur demande avec les codes spécifiques du tableau en pièce jointe, en indiquant la couleur souhaitée. / Die restlichen Farben können auf Anfrage unter Verwendung der On-Demand-Codes in der nebenstehenden Tabelle unter Angabe der gewünschten Farbe bestellt werden. / El resto de colores se pueden pedir a través de los códigos de la tabla, eligiendo colores y acabados como desee.



**FRONDS\_A CARBON GROUND 1+2+3+4**  
cod.9000236

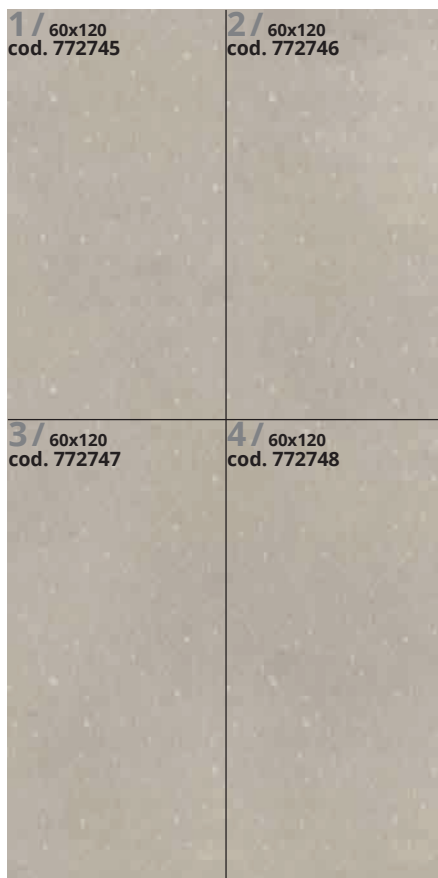

**FRONDS\_B DESERT GROUND 1+2+3+4**  
cod.9000237

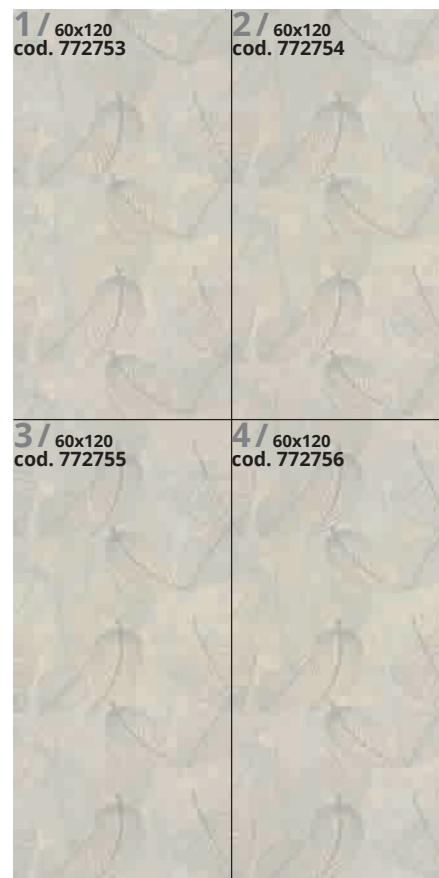

**LEAVES\_PUMICE GROUND 1+2+3+4**  
cod.9000238

Ordinando il codice es **9000236** il cliente riceverà 4 scatole, ogni scatola contiene 2 pz di ciascuna grafica. - By ordering code (for example **9000236**) the customer will receive 4 boxes, each box contains 2 pcs of each graphics. - En commandant le code (par exemple **9000236**) le client recevra 4 boites, chaque boite contiendra 2 de chaque graphique. - Bei Bestellung des Codes (z.B. **9000236**) erhält der Kunde 4 Kartons, jeder Karton enthält 2 Stück von jeder Grafik. - Al pedir el código (por ejemplo, 9000236), el cliente recibirá 4 cajas, cada caja contendrá 2 piezas de cada gráfica.

Ordinando il codice es **772737** il cliente riceverà una scatola contenente 2 pezzi della grafica **1**. - By ordering code (for example **772737**) the customers will receive 2 pcs of the design **1**. - En commandant le code (par exemple **772737**) le client recevra 1 boite, qui contiendra 2 pièces du motif **1**. - Mit der Bestellung des Codes (z.B. **772737**) erhält der Kunde eine Schachtel mit 2 Grafiken **1**. - Al pedir el código (por ejemplo, **772737**), el cliente recibirá una caja que contendrá 2 piezas del gráfico **1**.

**EARTHTECH/DECORS** nel formato 60x120 identificati dai codici **9000 1234** compongono il disegno nel formato 120x240, nel caso di danneggiamento di uno dei 4 pezzi si possono ordinare separatamente facendo riferimento al codice seriale seguito dal numero. / **EARTHTECH/DECORS** size 60x120 identified by item codes **9000 1234** compose the design in size 120x240; should one of the elements be damaged, they can be ordered separately making reference to the serial number followed by number. / **EARTHTECH/DECORS** identifiés pour le format 60x120 avec les codes **9000 1234** composent le dessin dans le format 120x240 ; en cas d'endommagement d'une des 4 plaques, elle peuvent être commandées séparément en se référant au code de série suivi du numéro. / **EARTHTECH /DECORS** im 60x120-Format, die durch die **9000 1234** - Codes gekennzeichnet sind, bilden das Bild im 120x240-Format. Wenn eines der 4 Teile beschädigt ist, kann es unter Bezugnahme auf die Seriennummer gefolgt von der Kennzahl separat bestellt werden. / **EARTHTECH/DECORS** en el formato 60x120 identificado por los códigos **9000 1234** conforman el diseño en el formato 120x240; Si una de las 4 piezas está dañada, se puede pedir por separado haciendo referencia al código de serie seguido del número.

Ogni soggetto è caratterizzato da una decorazione che continua da pezzo a pezzo considerando 2 mm di fuga. Prima di passare alla fase di posa stendere i vari soggetti a terra per verificarne la continuità del prodotto. / Each panel features a pattern that continues from piece to piece with a 2 mm joint. Before laying, spread the various panels on the ground to check the pattern's continuity. / Chaque sujet se caractérise par une décoration qui continue d'une pièce à l'autre, en tenant compte de 2 mm de joint. Avant de passer à la phase de pose, étaler les différents sujets au sol, pour en vérifier la continuité de la décoration. / Jedes Muster ist von einem Dekor charakterisiert, das von Platte zu Platte weiterverläuft, wenn man von der 2 mm Fuge absieht. Sollte vor dem Verlegen die einzelnen Muster auf den Boden angeordnet werden, um die Kontinuität des Dekors zu prüfen. / Cada pieza se caracteriza por una decoración que continúa de una a otra con una fuga de 2 mm. Antes de pasar a la fase de colocación extender los diferentes motivos sobre el suelo para comprobar la continuidad de la decoración.

# DECORO TWIST

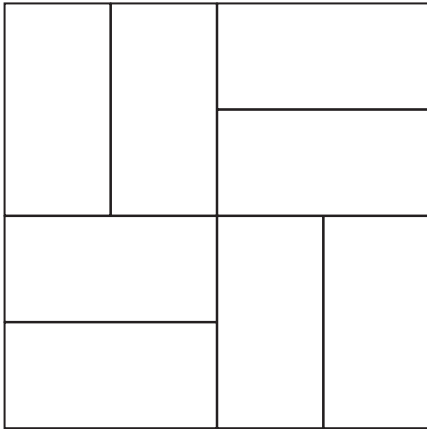

<b>9 mm</b> 3/8" ↑↓	COLOR	<b>30x30</b> 11 <sup>4/5"</sup> x11 <sup>4/5"</sup>
	TWIST_CARBON_FLAKES GLOSSY-BRIGHT PUMICE_FLAKES COMFORT	772716 ■ FL-30000
<b>EARTHTECH</b>	TWIST*	772724 ■ FL-36500
<b>6 mm</b> 1/4" ↑↓	COLOR	<b>30x30</b> 11 <sup>4/5"</sup> x11 <sup>4/5"</sup>
	TWIST*	772723 ■ FL-36500
<b>EARTHTECH</b>	TWIST*	772723 ■ FL-36500











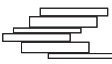

Il decoro TWIST è disponibile a magazzino nei colori CARBON FLAKES GLOSSY-BRIGHT+PUMICE FLAKES COMFORT nel formato 30x30. / The TWIST décor is available in stock in the colours CARBON FLAKES GLOSSY-BRIGHT+PUMICE FLAKES COMFORT in the size 30x30 cm. / Le décor TWIST est disponible en stock dans les couleurs CARBON FLAKES GLOSSY-BRIGHT + PUMICE FLAKES COMFORT en format 30x30. / Der Dekor TWIST ist in den Farben CARBON FLAKES GLOSSY-BRIGHT + PUMICE FLAKES COMFORT im Format 30x30 als Lagerware bestellbar. / La decoración TWIST está disponible en stock en los colores CARBON FLAKES GLOSSY-BRIGHT + PUMICE FLAKES COMFORT en el formato 30x30.

\*I restanti colori sono ordinabili su richiesta tramite i codici on demand della tabella, scegliendo colori e finiture nel modo in cui si desidera. / The remaining colours can be ordered on request using the "on demand" codes in the table, specifying the desired colours and finishes. / Les autres couleurs peuvent être commandées sur demande avec les codes spécifiques du tableau en pièce jointe, en indiquant les couleurs et les finitions souhaitées. / Die restlichen Farben können auf Anfrage über die On-Demand-Codes der Tabelle bestellt werden, wobei Farben und Oberflächen nach Ihren Wünschen ausgewählt werden. / El resto de colores se pueden pedir a través de los códigos de la tabla, eligiendo colores y acabados como desee.

EARTHTECH	scatola - box			pallet		
	pz	mq	kg	box	mq	kg
30x30 twist <b>9mm</b>	6	0,54	12,64	60	32,40	780
30x30 twist ON DEMAND <b>9mm</b>	6	0,54	12,64	36	19,44	480
30x30 twist <b>6mm</b>	9	0,81	12,00	36	29,16	450



# EARTHTECH

9 mm 3/8" ↑	COLOR	SURFACE	30x30 11 4/5" x 11 4/5"	21x40 8 1/4" x 15 3/4"
			 mosaico tessere 3x3 pz/box 11	 modulo listello sfalsato
	PUMICE_GROUND	COMFORT	772393 ▲ FL-02000	772417 ■ FL-17200
	PUMICE_FLAKES	COMFORT	772399 ▲ FL-03100	772423 ■ FL-19900
		GLOSSY-BRIGHT	772435 ▲ FL-03800	772429 ■ FL-22600
	DESERT_GROUND	COMFORT	772394 ▲ FL-02000	772418 ■ FL-17200
	DESERT_FLAKES	COMFORT	772400 ▲ FL-03100	772424 ■ FL-19900
		GLOSSY-BRIGHT	772436 ▲ FL-03800	772430 ■ FL-22600
	FOG_GROUND	COMFORT	772395 ▲ FL-02000	772419 ■ FL-17200
	FOG_FLAKES	COMFORT	772401 ▲ FL-03100	772425 ■ FL-19900
		GLOSSY-BRIGHT	772437 ▲ FL-03800	772431 ■ FL-22600
	CARBON_GROUND	COMFORT	772396 ▲ FL-02000	772420 ■ FL-17200
		COMFORT	772402 ▲ FL-03100	772426 ■ FL-19900
	CARBON_FLAKES	GLOSSY-BRIGHT	772438 ▲ FL-03800	772432 ■ FL-22600
		COMFORT	772397 ▲ FL-02000	772421 ■ FL-17200
	SAVANNAH_GROUND	COMFORT	772397 ▲ FL-02000	772421 ■ FL-17200
	SAVANNAH_FLAKES	COMFORT	772403 ▲ FL-03100	772427 ■ FL-19900
		GLOSSY-BRIGHT	772439 ▲ FL-03800	772433 ■ FL-22600
	OUTBACK_GROUND	COMFORT	772398 ▲ FL-02000	772422 ■ FL-17200
	OUTBACK_FLAKES	COMFORT	772404 ▲ FL-03100	772428 ■ FL-19900
		GLOSSY-BRIGHT	772440 ▲ FL-03800	772434 ■ FL-22600

EARTHTECH













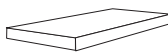

EARTHTECH	scatola - box			pallet		
	pz	mq	kg	box	mq	kg
60x60	3	1,08	23,87	40	43,20	980
60x120	2	1,44	34,27	30	43,20	1050
21x40 mod. list. sfalsato	5	0,42	9,66	40	16,80	420

EARTHTECH	scatola - box			pallet		
	pz	ml	kg	box	mq	kg
4,6x60 battiscopa	14	8,40	8,40	-	-	-











# Architectural design

PEZZI SPECIALI/SPECIAL TRIMS/PIÈCES SPÉCIALES/FORMSTÜCKE/PIEZAS ESPECIALES

9 mm 3/8" 

	COLOR	SURFACE	4,6x60 1 4/8"x23 5/8"  battiscopa	33x120x3 13"x47 1/4"x1 1/6"  angolo gradino DX pz/box 2	33x120x3 13"x47 1/4"x1 1/6"  gradino pz/box 2	33x120x3 13"x47 1/4"x1 1/6"  angolo gradino SX pz/box 2	
<b>EARTHTECH</b>		PUMICE_GROUND	COMFORT	772441 ◆ FL-01600	772485 ▲ FL-31100	772466 ▲ FL-20400	772491 ▲ FL-31100
		PUMICE_FLAKES	COMFORT	772447 ◆ FL-01600	772499 ▲ FL-31100	772472 ▲ FL-20400	772505 ▲ FL-31100
			GLOSSY-BRIGHT	772453 ◆ FL-01600	772511 ▲ FL-36500	772478 ▲ FL-22600	772517 ▲ FL-36500
		DESERT_GROUND	COMFORT	772442 ◆ FL-01600	772486 ▲ FL-31100	772467 ▲ FL-20400	772492 ▲ FL-31100
		DESERT_FLAKES	COMFORT	772448 ◆ FL-01600	772500 ▲ FL-31100	772473 ▲ FL-20400	772506 ▲ FL-31100
			GLOSSY-BRIGHT	772454 ◆ FL-01600	772512 ▲ FL-36500	772479 ▲ FL-22600	772518 ▲ FL-36500
		FOG_GROUND	COMFORT	772443 ◆ FL-01600	772487 ▲ FL-31100	772468 ▲ FL-20400	772493 ▲ FL-31100
		FOG_FLAKES	COMFORT	772449 ◆ FL-01600	772501 ▲ FL-31100	772474 ▲ FL-20400	772507 ▲ FL-31100
			GLOSSY-BRIGHT	772455 ◆ FL-01600	772513 ▲ FL-36500	772480 ▲ FL-22600	772519 ▲ FL-36500
		CARBON_GROUND	COMFORT	772444 ◆ FL-01600	772488 ▲ FL-31100	772469 ▲ FL-20400	772494 ▲ FL-31100
		CARBON_FLAKES	COMFORT	772450 ◆ FL-01600	772502 ▲ FL-31100	772475 ▲ FL-20400	772508 ▲ FL-31100
			GLOSSY-BRIGHT	772456 ◆ FL-01600	772514 ▲ FL-36500	772481 ▲ FL-22600	772520 ▲ FL-36500
		SAVANNAH_GROUND	COMFORT	772445 ◆ FL-01600	772489 ▲ FL-31100	772470 ▲ FL-20400	772496 ▲ FL-31100
		SAVANNAH_FLAKES	COMFORT	772451 ◆ FL-01600	772503 ▲ FL-31100	772476 ▲ FL-20400	772509 ▲ FL-31100
			GLOSSY-BRIGHT	772457 ◆ FL-01600	772515 ▲ FL-36500	772482 ▲ FL-22600	772521 ▲ FL-36500
		OUTBACK_GROUND	COMFORT	772446 ◆ FL-01600	772490 ▲ FL-31100	772471 ▲ FL-20400	772497 ▲ FL-31100
		OUTBACK_FLAKES	COMFORT	772452 ◆ FL-01600	772504 ▲ FL-31100	772477 ▲ FL-20400	772510 ▲ FL-31100
			GLOSSY-BRIGHT	772458 ◆ FL-01600	772516 ▲ FL-36500	772483 ▲ FL-22600	772522 ▲ FL-36500

# EARTHTECH

		PEZZI SPECIALI/SPECIAL TRIMS PIÈCES SPÉCIALES/FORMSTÜCKE PIEZAS ESPECIALES				
6 mm 1/4" 		COLOR	SURFACE	30x30 11 4/5"x11 4/5"  mosaico tessere 7,5x7,5 pz/box 11	30x30 11 4/5"x11 4/5"  muretto tessere 7,5x15 pz/box 11	4,6x60 1 4/5"x23 5/8"  battiscopa
EARTHTECH		PUMICE_GROUND	COMFORT	772405 ▲ FL-01800	772523 ▲ FL-01800	772459 ◆ FL-01800
		DESERT_GROUND	COMFORT	772406 ▲ FL-01800	772524 ▲ FL-01800	772460 ◆ FL-01800
		FOG_GROUND	COMFORT	772407 ▲ FL-01800	772525 ▲ FL-01800	772461 ◆ FL-01800
		CARBON_GROUND	COMFORT	772408 ▲ FL-01800	772526 ▲ FL-01800	772462 ◆ FL-01800
		SAVANNAH_GROUND	COMFORT	772409 ▲ FL-01800	772527 ▲ FL-01800	772463 ◆ FL-01800
		OUTBACK_GROUND	COMFORT	772410 ▲ FL-01800	772528 ▲ FL-01800	772464 ◆ FL-01800

FLORM OVERSIZE  
**magnum**

**120x280/120x240/120x120/60x120**  
 Specifica Imballo pag.  
 Packaging specifications on page  
 Spécifications d'emballage à page  
 Verpackungsdetail Seite  
 Especificaciones de embalaje a la página  
**194/195**

**Per un effetto ottimale della posa, Florim suggerisce di mantenere 2 mm di fuga per pose monofornato e 3 mm per combinare formati misti** - For optimal installation results, Florim recommends maintaining a joint of 2 mm 1/12" for single format installations and 3 mm 1/8" to combine mixed formats. - Pour réaliser une pose parfait, Florim conseille de laisser 2 mm de joint pour la pose des monofornats et 3 mm pour les combinaisons de formats mixtes. - Um einen optimalen effekt beim verlegen zu erzielen empfiehlt Florim eine 2 mm fuge bei einformatigen verlegungen und 3 mm fuge bei formatkombinationen - Para lograr los máximos resultados en la posa del producto, Florim aconseja 2 mm de junta en aplicaciones monofornato y 3 mm en combinaciones de formatos mixtos.

**In relazione alle differenti tecnologie produttive l'accostamento di prodotti con spessori diversi potrebbe presentare delle disomogeneità, se ne sconsiglia pertanto l'abbinamento.** / Due to the different production technologies, contiguous installation of products with different thickness may give a non-homogeneous result. For this reason we do not recommend this option. / Vu que différentes technologies de production sont utilisées avec des épaisseurs différentes, des problèmes d'homogénéité pourraient se présenter, il est donc déconseillé de les poser ensemble. / Wegen unterschiedlicher Produktionstechnologien können die Fliesen mit verschiedenen Materialstärken optische Differenzen aufweisen. Von einem direkten Aneinanderlegen wird deshalb abgeraten. / Dadas las diferentes tecnologías productivas, la combinación de productos de diferentes espesores podría dar lugar a heterogeneidad, por lo que se desaconseja mezclarlas.





# EARTHTECH OUTDOOR

## Vantaggi tecnici - Technical advantages - Avantages techniques Technische Vorteile - Ventajas técnicas

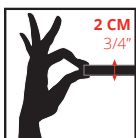

- Lastra monolitica compatta di spessore 2 cm squadrata e rettificata
- Compact monolithic slab 2 cm thick squared and rectified
- Dalle monolithique compacte de 2 cm d'épaisseur, équarrie et rectifiée
- Kompakte monolithische Platte, 2 cm dick, rechteckig und scharfkantig geschliffen
- Losa monolítica compacta de 2 cm de espesor, escuadrada y rectificada.

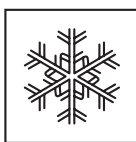

- INGELIVO
- FROST RESISTANT
- INGÉLIF
- FROSTBESTÄNDIG
- RESISTENTE A LA HELADA



- ELEVATA RESISTENZA AI CARICHI STATICI
- HIGH STATIC LOAD RESISTANCE
- RÉSISTANCE ÉLEVÉE AUX CHARGES STATIQUES
- HOHE STATISCHE BELASTBARKEIT
- ELEVADA RESISTENCIA A LAS CARGAS ESTÁTICAS



- FACILE DA POSARE
- EASY TO INSTALL
- FACILE À POSER
- VERLEGELEICHT
- FÁCIL DE COLOCAR



- ANTISCIVOLO R11
- ANTI SLIP R11
- ANTIDÉRAPANT R11
- RUTSCHFEST R11
- ANTIDESLIZANTE R11

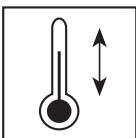

- RESISTENTE AGLI SBALZI TERMICI
- THERMAL SHOCK RESISTANT
- RÉSISTANT AUX ÉCARTS THERMIQUES
- TEMPERATURWECHSELBESTÄNDIG
- RESISTENTE A LAS OSCILACIONES TÉRMICAS



- FACILE DA PULIRE
- EASY TO CLEAN
- FACILE À NETTOYER
- REINIGUNGSLEICHT
- FÁCIL DE LIMPIAR

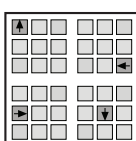

- RIMOVIBILE E RIUTILIZZABILE
- REMOVABLE AND REUSABLE
- DÉMONTABLE ET RÉUTILISABLE
- ENTFERNBAR UND WIEDERVERWENDBAR
- DESMONTABLE Y REUTILIZABLE



- INATTACCABILE DA AGENTI CHIMICI E MUFFE
- IMPERVIOUS TO ATTACK BY CHEMICALS OR MOULD
- RÉSISTANT AUX AGENTS CHIMIQUES ET AUX MOISSISSURES
- UNANGREIFBAR DURCH CHEMISCHE STOFFE UND SCHIMMEL
- RESISTENTE A LOS AGENTES QUÍMICOS Y A LOS MOHOS

## Applicazioni - Applications - Applications - Verlegung - Aplicaciones

- Posa diretta su erba
- Direct installation on grass
- Pose directe sur de l'herbe
- Verlegung direkt auf Rasen
- Colocación directa sobre hierba

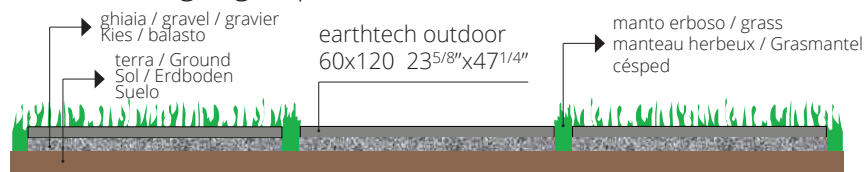

- Posa diretta su ghiaia
- Direct installation over gravel
- Pose direct sur du gravier
- Verlegung direkt auf Kies
- Colocación directa sobre grava



- Posa su massetto cementizio
- Installation on sand-cement screed
- Pose sur chape ciment
- Verlegung auf Zement-Unterbetonblock
- Colocación sobre contrapiso de hormigón

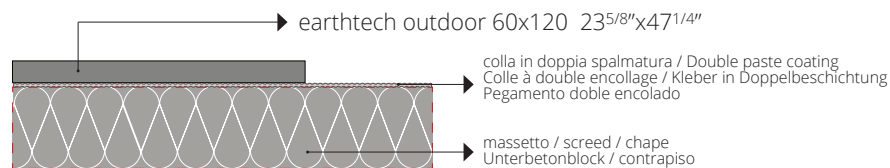

- Posa su piedini fissi o regolabili
- Installation on fixed or adjustable feet
- Pose sur pieds fixes ou réglables
- Verlegung auf feststehende oder regulierbare Füße
- Colocación sobre pies fijos o regulables

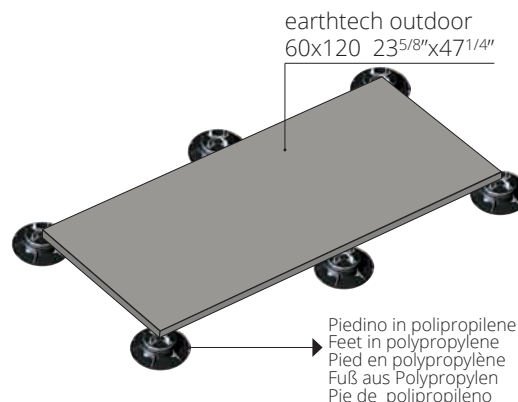

Per le specifiche di utilizzo dei sistemi sopraelevati vedi il sito florim.com  
For the specifics on use of raised systems visit the site florim.com  
Pour les caractéristiques d'utilisation des systèmes surélevés, voir le site florim.com  
Für die Nutzungsbedingungen der Doppelbodensysteme siehe Webseite florim.com  
Para las especificaciones de empleo de los sistemas sobreelevados consulte el sitio web florim.com

Le lastre ceramiche sono sottoposte a un trattamento di compattazione termica che assicura resistenza e durata nel tempo. Il bassissimo assorbimento d'acqua rende perciò il materiale ingelivo. Ciò può comportare ristagni d'acqua superficiali anche per materiale installato a regola d'arte. / Ceramic tiles undergo a compacting thermal treatment that ensures resistance and durability. The low level of water absorption makes the slabs frost resistant. This could result in superficial water stagnations even if materials are installed in a workmanlike manner. / Les carreaux de céramique subissent un traitement thermique de compactage qui assure résistance et durabilité. Le faible niveau d'absorption d'eau rend les dalles résistantes au gel. Il pourrait en résulter des stagnations d'eau superficielles, même si les dalles ont été installées dans les règles de l'art. / Die Keramikplatten werden einer thermischen Verdichtung unterzogen, welche die Widerstandsfähigkeit und Langlebigkeit sichert. Die extrem niedrige Wasseraufnahme macht das Material frostsicher. Die hohe Materialdichte kann, auch bei einer perfekten Verlegung, eine längere Abtrocknungszeit von angestaumtem Wasser zur Folge haben. / Las baldosas cerámicas se someten a un tratamiento de compactación térmica que asegura resistencia y durabilidad. La baja absorción de agua hace que las baldosas resistan al hielo. Esto podría resultar en estancamientos superficiales de agua, incluso si los materiales están instalados según las reglas del arte.

## PUMICE\_GROUND



## DESERT\_GROUND



**R11  
CLASSE C**

BS EN 16165  
ANNEX C  
>36 wet  
slider 96

DCOF>  
0,42 Wet

**20 mm 3/4" ↑**

## FOG\_GROUND



## CARBON\_GROUND



### GRES FINE PORCELLANATO

FINE PORCELAIN STONEWARE/GRES CERAME FIN/FEINSTEINZEUG-KOLLEKTIONEN/GRES PORCELANICO FINO  
SQUADRATO - SQUARED - EQUARRI - REKTIFIZIERT - ESCUADRADO

**20 mm 3/4" ↑**

	COLOR	SURFACE	60x120 23 <sup>5/8"</sup> x47 <sup>1/4"</sup>
<b>EARTHTECH</b>	PUMICE_GROUND	GRIP	771805 ■ FL-10300
	DESERT_GROUND	GRIP	771806 ■ FL-10300
	FOG_GROUND	GRIP	771807 ■ FL-10300
	CARBON_GROUND	GRIP	771808 ■ FL-10300



### PUMICE\_GROUND

ISO 10545-4	RESISTENZA ALLA FLESSIONE IN N/mm <sup>2</sup> N/mm <sup>2</sup> FLEXURAL STRENGTH TEST / RESISTANCE A LA FLEXION EN N/mm <sup>2</sup> / BIEGEFESTIGKEIT IN N/mm <sup>2</sup> / RESISTENCIA A LA FLEXION EN N/mm <sup>2</sup>	valore medio 52 N/mm <sup>2</sup>
	Forza di rottura in N (sp. > 7,5 mm) Breaking strength in N (thickness > 7,5 mm) / Force de rupture en N (ép. > 7,5 mm) / Bruchlast in N (Dicke > 7,5 mm) / Fuerza de rotura en N (g. > 7,5 mm)	valore medio 14000 N

<b>EARTHTECH</b>	scatola - box			pallet		
	pz	mq	kg	box	mq	kg
60x120 20mm	1	0,72	32,26	30	21,60	1000

### PEZZI SPECIALI

Special trims/Pièces spéciales/Formstücke  
Piezas especiales

pag 184/187

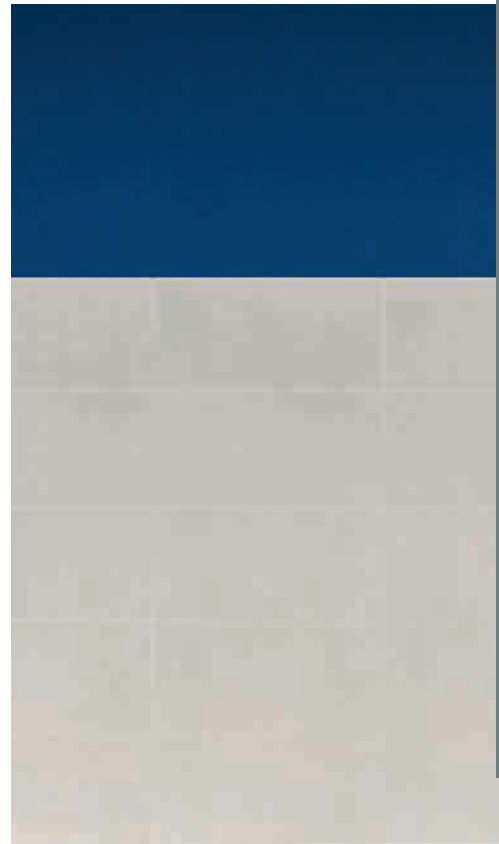

# FLOORTECH/1.0

gres fine porcellanato  
fine porcelain stoneware  
grès cérame fin  
feinsteinzeug-kollektionen  
gres porcelánico fino

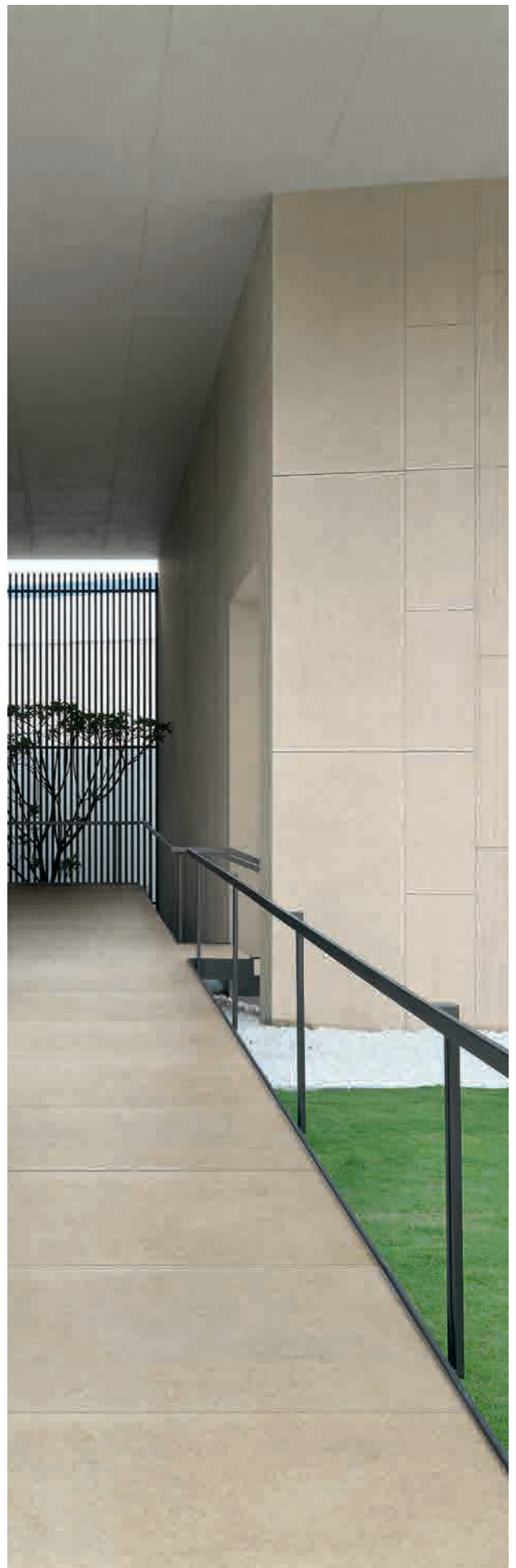





## FLOORTECH/1.0

L'importanza delle origini, la forza della materia, la fantasia delle lavorazioni si uniscono alle atmosfere di una cultura millenaria capace di rendersi moderna grazie ad una tecnologia perfetta. **Floortech/1.0** continua il percorso di ricerca che Florim da sempre insegue, lontano da stili omologati, in continua sfida e sperimentazione queste 4 pietre sono il simbolo di una scelta forte e personale, capaci di dare vita a progetti intuitivi di colori e superfici per nuove forme abitative.

The importance of origin, the strength of matter and the creativity of processing are all combined with the atmospheres of a thousand-year-old culture, using the perfect technology to become modern. **Floortech/1.0** continues in the same vein of sophistication that Florim has always pursued, setting itself apart from standard styles, continuously challenging and experimenting. These 4 stones are the symbol of a strong and personal choice, giving life to intuitive projects with colours and surfaces to create new shapes of living.

L'importance des origines, la force de la matière, l'originalité des traitements épousent l'ambiance d'une culture millénaire capable de devenir moderne grâce à une technologie parfaite. **Floortech/1.0** poursuit le parcours de recherche que Florim suit depuis toujours, loin des styles homologués. Symbole d'un choix fort et personnel, ces 4 pierres qui vivent un défi et une expérience permanents, donnent naissance à des projets aux coloris et aux surfaces intuitifs pour de nouvelles formes habitatives.

Die Bedeutung der Ursprünge, die Kraft der Materie und die Fantasie der Bearbeitungen vereinen sich mit den Atmosphären einer tausendjährigen Kultur, die dank einer perfekten Technologie in der Lage ist, modern zu werden. **Floortech/1.0** setzt den Forschungsweg fort, den Florim seit jeher verfolgt. Weit ab von vereinheitlichten Stilen, in einer kontinuierlichen Herausforderung und Experimentierung sind diese 4 Steine Symbol einer starken und persönlichen Entscheidung und in der Lage, intuitiven Projekten aus Farben und Oberflächen für neue Wohnformen Leben zu verleihen.

La importancia de los orígenes, la fuerza de la materia, la fantasía de las elaboraciones se unen a las atmósferas de una cultura milenaria capaz de modernizarse gracias a una tecnología perfecta. **Floortech/1.0** sigue el camino de búsqueda que siempre ha perseguido Florim, alejado de los estilos homologados, con un constante desafío y experimentación. Estas 4 piedras son el símbolo de una decisión fuerte y personal, capaces de dar vida a proyectos intuitivos de colores y superficies para nuevas formas habitacionales.

# FLOORTECH/1.0

## FLOOR 1.0



## FLOOR 2.0



**V2**  
**R10**  
**Classe B**  
(naturale)

**R9**  
(soft)

**R11**  
**Classe C**  
(strutturato)

DCOF>  
0,42 Wet  
(naturale/  
strutturato/  
soft)

9 mm 3/8" ↑↓

### GRES FINE PORCELLANATO

FINE PORCELAIN STONEWARE / GRÈS CÉRAME FIN / FEINSTEINZEUG-KOLLEKTIONEN / GRES PORCELÁNICO FINO  
SQUADRATO - SQUARED - EQUARRI - REKTIFIZIERT - ESCUADRADO

9 mm 3/8" ↑↓		COLOR	SURFACE	60x120 23 <sup>5/8</sup> "x47 <sup>1/4</sup> "	80x80 31 <sup>1/2</sup> "x31 <sup>1/2</sup> "	60x60 23 <sup>5/8</sup> "x23 <sup>5/8</sup> "	30x60 11 <sup>4/5</sup> "x23 <sup>5/8</sup> "
FLOORTECH/1.0	FLOOR 1.0	■	NATURALE	-	-	739682 ■ FL-06400	-
			STRUTTURATO	738522 ■ FL-09100	-	738558 ■ FL-06400	738540 ■ FL-05300
			SOFT	738508 ■ FL-09100	738425 ■ FL-08400	738549 ■ FL-06400	738531 ■ FL-05300
	FLOOR 2.0	■	NATURALE	-	-	739683 ■ FL-06400	-
			STRUTTURATO	738523 ■ FL-09100	-	738559 ■ FL-06400	738541 ■ FL-05300
			SOFT	738514 ■ FL-09100	738426 ■ FL-08400	738550 ■ FL-06400	738532 ■ FL-05300

## FLOOR 3.0



## FLOOR 9.0

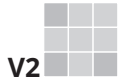

V2

**R10**  
**Classe B**  
(naturale)

**R9**  
(soft)



**R11**  
**Classe C**  
(strutturato)

DCOF>  
0,42 Wet  
(naturale/  
strutturato/  
soft)

9 mm 3/8" ↑↓

### GRES FINE PORCELLANATO

FINE PORCELAIN STONEWARE / GRÈS CÉRAMÉ FIN / FEINSTEINZEUG-KOLLEKTIONEN / GRES PORCELÁNICO FINO  
SQUADRATO - SQUARED - EQUARRI - REKTIFIZIERT - ESCUADRADO





9 mm 3/8" ↑↓		COLOR	SURFACE	60x120 23 <sup>5/8"</sup> x47 <sup>1/4"</sup>	80x80 31 <sup>1/2"</sup> x31 <sup>1/2"</sup>	60x60 23 <sup>5/8"</sup> x23 <sup>5/8"</sup>	30x60 11 <sup>4/5"</sup> x23 <sup>5/8"</sup>
FLOORTECH/1.0	FLOOR 3.0		NATURALE	-	-	739684 ■ FL-06400	-
			STRUTTURATO	738524 ■ FL-09100	-	738560 ■ FL-06400	738542 ■ FL-05300
			SOFT	738515 ■ FL-09100	738427 ■ FL-08400	738551 ■ FL-06400	738533 ■ FL-05300
	FLOOR 9.0		NATURALE	-	-	739690 ■ FL-06400	-
			STRUTTURATO	738530 ■ FL-09100	-	738566 ■ FL-06400	738548 ■ FL-05300
			SOFT	738521 ■ FL-09100	738433 ■ FL-08400	738557 ■ FL-06400	738539 ■ FL-05300

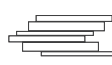
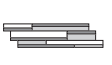
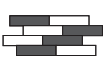



# FLOORTECH/1.0

9 mm 3/8" ↑↓							
		COLOR	SURFACE				
				<b>30x30</b> 1 1/4" x 1 1/4"	<b>21x40</b> 8 1/4" x 15 3/4"	<b>15x60</b> 6" x 23 5/8"	<b>30x60</b> 1 1/4" x 23 5/8"
				 mosaico tessera 5x5	 modulo listello sfalsato	 modulo listello mix 3D pz/box 6	 modulo listello mix 3D (soft/strutturato) pz/box 4
<b>FLOORTECH/1.0</b>		FLOOR 1.0	SOFT	738967 ■ FL-15100	738985 ■ FL-21000	738976 ▲ FL-03600	739392 ▲ FL-07300
		FLOOR 2.0	SOFT	738968 ■ FL-15100	738986 ■ FL-21000	738977 ▲ FL-03600	739393 ▲ FL-07300
		FLOOR 3.0	SOFT	738969 ■ FL-15100	738987 ■ FL-21000	738978 ▲ FL-03600	739394 ▲ FL-07300
		FLOOR 9.0	SOFT	738975 ■ FL-15100	738993 ■ FL-21000	738984 ▲ FL-03600	739400 ▲ FL-07300

## PEZZI SPECIALI/SPECIAL TRIMS/PIÈCES SPÉCIALES/FORMSTÜCKE/PIEZAS ESPECIALES

9 mm 3/8" ↑↓								
		COLOR	SURFACE					
				<b>4,6x60</b> 1 4/5" x 23 5/8"	<b>33x120x3</b> 13" x 47 1/4" x 1 1/8"	<b>33x120x3</b> 13" x 47 1/4" x 1 1/8"	<b>33x120x3</b> 13" x 47 1/4" x 1 1/8"	<b>33x120x3</b> 13" x 47 1/4" x 1 1/8"
				 battiscopa	 gradino pz/box 2	 angolo gradino dx pz/box 2	 angolo gradino sx pz/box 2	 angolo gradino dx/sx pz/box 1
<b>FLOORTECH/1.0</b>	FLOOR 1.0		SOFT	745511 ◆ FL-01600	739049 ▲ FL-20400	739058 ▲ FL-31100	739067 ▲ FL-31100	739374 ▲ FL-45000
			STRUTTURATO	-	739076 ▲ FL-20400	739085 ▲ FL-31100	739094 ▲ FL-31100	739383 ▲ FL-45000
	FLOOR 2.0		SOFT	745512 ◆ FL-01600	739050 ▲ FL-20400	739059 ▲ FL-31100	739068 ▲ FL-31100	739375 ▲ FL-45000
			STRUTTURATO	-	739077 ▲ FL-20400	739086 ▲ FL-31100	739095 ▲ FL-31100	739384 ▲ FL-45000
	FLOOR 3.0		SOFT	745513 ◆ FL-01600	739051 ▲ FL-20400	739060 ▲ FL-31100	739069 ▲ FL-31100	739376 ▲ FL-45000
			STRUTTURATO	-	739078 ▲ FL-20400	739087 ▲ FL-31100	739096 ▲ FL-31100	739385 ▲ FL-45000
	FLOOR 9.0		SOFT	745519 ◆ FL-01600	739057 ▲ FL-20400	739066 ▲ FL-31100	739075 ▲ FL-31100	739382 ▲ FL-45000
			STRUTTURATO	-	739084 ▲ FL-20400	739093 ▲ FL-31100	739102 ▲ FL-31100	739391 ▲ FL-45000

9 mm 3/8" ↑↓					
		COLOR	SURFACE		
				<b>1,2x20</b> 1/2" x 7 7/8"	<b>1,2x20</b> 1/2" x 7 7/8"
				 quarter round pz/box 12	 angolo quarter round pz/box 4
<b>FLOORTECH/1.0</b>		FLOOR 1.0	SOFT	739112 ▲ FL-01160	739121 ▲ FL-01800
		FLOOR 2.0	SOFT	739113 ▲ FL-01160	739122 ▲ FL-01800
		FLOOR 3.0	SOFT	739114 ▲ FL-01160	739123 ▲ FL-01800
		FLOOR 9.0	SOFT	739120 ▲ FL-01160	739129 ▲ FL-01800

# Architectural design

9 mm 3/8" ↑↓

COLOR

SURFACE

**60x60**  
23<sup>5/8"</sup>x23<sup>5/8"</sup>

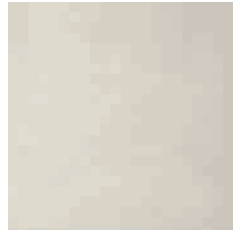

DECOR  
FLOOR 1.0

SOFT

738680  
■ FL-06700



DECOR  
FLOOR 2.0

SOFT

738681  
■ FL-06700

**FLOORTECH/1.0**



DECOR  
FLOOR 3.0

SOFT

738682  
■ FL-06700



DECOR  
FLOOR 9.0

SOFT

738688  
■ FL-06700

FLOORTECH/1.0	scatola - box			pallet		
	pz	mq	kg	box	mq	kg
60x120	2	1,44	28,08	30	43,20	870
80x80	2	1,28	24,96	40	51,20	1030
60x60	3	1,08	21,06	40	43,20	870
30x60	6	1,08	20,84	40	43,20	860
60x60 decor soft	3	1,08	21,06	40	43,20	870
21x40 mod. list. sfalsato	5	0,42	9,66	40	16,80	420

FLOORTECH/1.0	scatola - box			pallet		
	pz	ml	kg	box	mq	kg
4,6x60 battiscopa	14	8,40	8,40	-	-	-

**Per un effetto ottimale della posa, Florim suggerisce di mantenere 2 mm di fuga per pose monoformato e 3 mm per combinare formati misti** - For optimal installation results, Florim recommends maintaining a joint of 2 mm - 1/12" for single format installations and 3 mm - 1/8" to combine mixed formats. - Pour réaliser une pose parfait, Florim conseille de laisser 2 mm de joint pour la pose des monoformats et 3 mm pour les combinaisons de formats mixtes. - Um einen optimalen effekt beim verlegen zu erzielen empfiehlt Florim eine 2 mm fugе bei einformatigen verlegungen und 3 mm fugе bei formatkombinationen - Para lograr los máximos resultados en la posa del producto, Florim aconseja 2 mm de junta en aplicaciones monoformato y 3 mm en combinaciones de formatos mixtos.





# FLOWTECH

gres fine porcellanato  
fine porcelain stoneware  
grès cérame fin  
feinsteinzeug-kollektionen  
gres porcelánico fino







## FLOWTECH

Le lastre **Flowtech** permettono di arricchire ambienti pubblici e privati con il deciso fascino industriale delle lamiere metalliche. L'estetica coglie tutti i tratti iconici del materiale: è curata anche nei piccoli particolari e perfettamente bilanciata. A questo si aggiunge il vantaggio di un aspetto totalmente stabile nel tempo, e di una materia che non risente dell'umidità, dell'usura o di agenti atmosferici. Le tre varianti colore insieme all'assortimento di formati, dalle grandi lastre ai pratici sottoformati in varie misure, agevolano la posa in opera e la versatilità architettonica della collezione.

**Flowtech** panels enrich public and private spaces with the industrial charm of metallic sheeting. The aesthetic expresses all the iconic features of the material, even down to the smallest details, in perfect equilibrium. They also have the benefit of being unchanged by the passage of time, in a material which is immune to the effects of humidity, wear and atmospheric agents. The three colour variants, combined with a variety of sizes, from large panels to a number of handy smaller formats, make them easy to install and adapt to any setting.

Les dalles **Flowtech** confèrent aux espaces publics et privés le charme typiquement industriel des tôles métalliques. Leur esthétique, qui met en évidence toutes les caractéristiques du matériau, est soignée dans les moindres détails et parfaitement équilibrée. À cela s'ajoute l'avantage d'un aspect extrêmement durable et d'une matière résistante à l'humidité, à l'usure et aux agents atmosphériques. Les trois variantes de couleurs et l'assortiment de formats disponibles, des grandes dalles aux sous-formats pratiques proposés en plusieurs dimensions, facilitent la pose et permettent son application dans différents contextes architecturaux.

Die Platten von **Flowtech** machen es möglich öffentliche und private Bereiche um den deutlichen industriellen Reiz der Metallbleche zu bereichern. Die Ästhetik birgt alle ikonischen Züge des Materials: es ist auch in den kleinsten Einzelheiten gepflegt und perfekt ausgewogen. Hinzu kommen die Vorteile eines auf die Dauer absolut beständigen Aussehens und eines Materials, dem Feuchtigkeit, Verschleiß oder Umwelteinflüsse nicht schaden können. Die drei Farbvarianten, zusammen mit dem Sortiment an Formaten, von den großen Platten bis zu den praktischen Unterformaten in verschiedenen Größen, erleichtern die Verlegung an Ort und Stelle und die architektonische Vielseitigkeit der Kollektion.

Las losas **Flowtech** permiten enriquecer ambientes públicos y privados con el intenso encanto industrial de las chapas metálicas. La estética abarca todos los rasgos icónicos del material: está cuidada incluso en los pequeños detalles y perfectamente equilibrada. A esto se añade la ventaja de un aspecto totalmente estable en el tiempo y de una materia que no se resiente a la humedad, al desgaste o a los agentes atmosféricos. Las tres variantes de color junto al surtido de formatos, desde las grandes losas hasta los prácticos subformatos en varias medidas, facilitan la colocación en la obra y la versatilidad arquitectónica de la colección.



## RUSSET



## AGED BRONZE

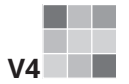

V4

R9

DCOF>  
0,42 Wet

9 mm 3/8" ↑↓

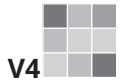

V4

R9

(naturale/  
matte)





DCOF>  
0,42 Wet

6 mm 1/4" ↑↓

FLORIM OVERSIZE  
magnUlm

### GRES FINE PORCELLANATO

FINE PORCELAIN STONEWARE / GRÈS CÉRAME FIN / FEINSTEINZEUG-KOLLEKTIONEN / GRES PORCELÁNICO FINO  
SQUADRATO - SQUARED - EQUARRI - REKTIFIZIERT - ESCUADRADO

9 mm 3/8" ↑↓		COLOR	SURFACE	60x120 23 <sup>5/8"</sup> x47 <sup>1/4"</sup>	80x80 31 <sup>1/2"</sup> x31 <sup>1/2"</sup>	40x80 15 <sup>3/4"</sup> x31 <sup>1/2"</sup>	60x60 23 <sup>5/8"</sup> x23 <sup>5/8"</sup>	30x60 11 <sup>4/5"</sup> x23 <sup>5/8"</sup>
FLOWTECH		RUSSET	NATURALE	757070 ■ FL-09100	757064 ■ FL-08400	757067 ■ FL-06400	757073 ■ FL-06400	757076 ■ FL-04600
		AGED BRONZE	NATURALE	757071 ■ FL-09100	757065 ■ FL-08400	757068 ■ FL-06400	757074 ■ FL-06400	757077 ■ FL-04600
6 mm 1/4" ↑↓		COLOR	SURFACE	160x320 63"x126"	160x160 63"x63"	120x240 47 <sup>1/4"</sup> x94 <sup>1/2"</sup>	120x120 47 <sup>1/4"</sup> x47 <sup>1/4"</sup>	60x120 23 <sup>5/8"</sup> x47 <sup>1/4"</sup>
FLOWTECH		RUSSET	NATURALE	757908 ■ FL-14500	757911 ■ FL-11900	756645 ■ FL-09900	757061 ■ FL-08400	757058 ■ FL-07700
		AGED BRONZE	NATURALE	757909 ■ FL-14500	757912 ■ FL-11900	756646 ■ FL-09900	757062 ■ FL-08400	757059 ■ FL-07700

## BURNISHED



V4

R9

DCOF >  
0,42 Wet

9 mm 3/8" ↑↓



V4

R9

(naturale/  
matte)

DCOF >  
0,42 Wet

6 mm 1/4" ↑↓

FLOHM OVERSIZE  
magnUm





**GRES FINE PORCELLANATO**  
FINE PORCELAIN STONEWARE / GRÈS CÉRAME FIN / FEINSTEINZEUG-KOLLEKTIONEN / GRES PORCELÁNICO FINO  
SQUADRATO - SQUARED - EQUARRI - REKTIFIZIERT - ESCUADRADO

9 mm 3/8" ↑↓	COLOR	SURFACE	60x120 23 <sup>5/8</sup> "x47 <sup>1/4</sup> "	80x80 31 <sup>1/2</sup> "x31 <sup>1/2</sup> "	40x80 15 <sup>3/4</sup> "x31 <sup>1/2</sup> "	60x60 23 <sup>5/8</sup> "x23 <sup>5/8</sup> "	30x60 11 <sup>4/5</sup> "x23 <sup>5/8</sup> "	
<b>FLOWTECH</b>		BURNISHED	NATURALE	757072 ■ FL-09100	757066 ■ FL-08400	757069 ■ FL-06400	757075 ■ FL-06400	757078 ■ FL-04600







6 mm 1/4" ↑↓	COLOR	SURFACE	160x320 63"x126"	160x160 63"x63"	120x240 47 <sup>1/4</sup> "x94 <sup>1/2</sup> "	120x120 47 <sup>1/4</sup> "x47 <sup>1/4</sup> "	60x120 23 <sup>5/8</sup> "x47 <sup>1/4</sup> "	
<b>FLOWTECH</b>		BURNISHED	NATURALE	757910 ■ FL-14500	757913 ■ FL-11900	756647 ■ FL-09900	757063 ■ FL-08400	757060 ■ FL-07700



# FLOWTECH

9 mm 3/8" ↑↓	COLOR	SURFACE	<b>21x40</b> 8 <sup>1/4"</sup> x15 <sup>3/4"</sup>  modulo listello sfalsato <b>pz/box 5</b>	
		RUSSET	NATURALE	756615 ▲ FL-01600
	<b>FLOWTECH</b> 	AGED BRONZE	NATURALE	756616 ▲ FL-01600
		BURNISHED	NATURALE	756617 ▲ FL-01600

## PEZZI SPECIALI/SPECIAL TRIMS/PIÈCES SPÉCIALES/FORMSTÜCKE/PIEZAS ESPECIALES









9 mm 3/8" ↑↓	COLOR	SURFACE	<b>4,6x80</b> 1 <sup>4/5"</sup> x31 <sup>1/2"</sup>  battiscopa	<b>33x120x3</b> 13"x47 <sup>1/4"</sup> x1 <sup>1/8"</sup>  gradino <b>pz/box 2</b>	<b>33x120x3</b> 13"x47 <sup>1/4"</sup> x1 <sup>1/8"</sup>  angolo gradino dx <b>pz/box 2</b>	<b>33x120x3</b> 13"x47 <sup>1/4"</sup> x1 <sup>1/8"</sup>  angolo gradino sx <b>pz/box 2</b>			
				RUSSET	NATURALE	756618 ◆ FL-01600	758216 ▲ FL-20400	758219 ▲ FL-31100	758222 ▲ FL-31100
			<b>FLOWTECH</b> 	AGED BRONZE	NATURALE	756619 ◆ FL-01600	758217 ▲ FL-20400	758220 ▲ FL-31100	758223 ▲ FL-31100
				BURNISHED	NATURALE	756620 ◆ FL-01600	758218 ▲ FL-20400	758221 ▲ FL-31100	758224 ▲ FL-31100



FLOWTECH	scatola - box			pallet		
	pz	mq	kg	box	mq	kg
60x120	2	1,44	28,08	30	43,20	870
80x80	2	1,28	24,96	40	51,20	1030
40x80	3	0,96	18,53	56	53,76	1070
60x60	3	1,08	21,49	40	43,20	890
30x60	6	1,08	21,49	40	43,20	890

FLOWTECH	scatola - box			pallet		
	pz	ml	kg	box	mq	kg
4,6x80 battiscopa	12	9,60	9,60	-	-	-

PEZZI SPECIALI/SPECIAL TRIMS  
PIÈCES SPÉCIALES/FORMSTÜCKE  
PIEZAS ESPECIALES

6 mm 1/4" 		COLOR	SURFACE	<b>30x30</b> 11 4/5" x 11 4/5"  mosaico tessere 7,5x7,5 pz/box 11	<b>30x30</b> 11 4/5" x 11 4/5"  muretto tessere 7,5x15 pz/box 11	<b>30x30</b> 11 4/5" x 11 4/5"  mosaico tessere 1,5x3 pz/box 11	<b>4,6x60</b> 1 4/5" x 23 5/8"  battiscopa
FLOWTECH		RUSSET	NATURALE	756624 ▲ FL-01800	756621 ▲ FL-01800	756627 ▲ FL-02700	756630 ◆ FL-01800
		AGED BRONZE	NATURALE	756625 ▲ FL-01800	756622 ▲ FL-01800	756628 ▲ FL-02700	756631 ◆ FL-01800
		BURNISHED	NATURALE	756626 ▲ FL-01800	756623 ▲ FL-01800	756629 ▲ FL-02700	756632 ◆ FL-01800

FLORIM OVERSIZE  
**magnUm**

**160x320/160x160/120x240/120x120/60x120**  
 Specifica Imballo pag.  
 Packaging specifications on page  
 Spécifications d'emballage à page  
 Verpackungsdetail Seite  
 Especificaciones de embalaje a la página  
**194/195**

**I formati 160x160 e 80x240 posso essere acquistati solo a multipli di 2 lastre.** / Sales unit for 160x160 and 80x240 is 2 pcs, so they can only be bought in multiples of 2. / Les formats 160x160 et 80x240 sont vendus par multiples de 2 plaques / Die Formate 160x160 und 80x240 können nur in einer durch 2 teilbaren Anzahl bestellt werden / Las medidas 160x160 y 80x240 solo pueden comprarse en múltiplos de 2 placas.

**Per un effetto ottimale della posa, Florim suggerisce di mantenere 2 mm di fuga per pose monoformato e 3 mm per combinare formati misti.** - For optimal installation results, Florim recommends maintaining a joint of 2 mm 1/12" for single format installations and 3 mm 1/8" to combine mixed formats. - Pour réaliser une pose parfait, Florim conseille de laisser 2 mm de joint pour la pose des monoformats et 3 mm pour les combinaisons de formats mixtes. - Um einen optimalen effekt beim verlegen zu erzielen empfiehlt Florim eine 2 mm fuge bei einformatigen verlegungen und 3 mm fuge bei formatkombinationen - Para lograr los máximos resultados en la posa del producto, Florim aconseja 2 mm de junta en aplicaciones monoformato y 3 mm en combinaciones de formatos mixtos.

**In relazione alle differenti tecnologie produttive l'accostamento di prodotti con spessori diversi potrebbe presentare delle disomogeneità, se ne sconsiglia pertanto l'abbinamento.** / Due to the different production technologies, contiguous installation of products with different thickness may give a non-homogeneous result. For this reason we do not recommend this option. / Vu que différentes technologies de production sont utilisées avec des épaisseurs différentes, des problèmes d'homogénéité pourraient se présenter, il est donc déconseillé de les poser ensemble. / Wegen unterschiedlicher Produktionstechnologien können die Fliesen mit verschiedenen Materialstärken optische Differenzen aufweisen. Von einem direkten Aneinanderlegen wird deshalb abgeraten. / Dadas las diferentes tecnologías productivas, la combinación de productos de diferentes espesores podría dar lugar a heterogeneidad, por lo que se desaconseja mezclarlas.

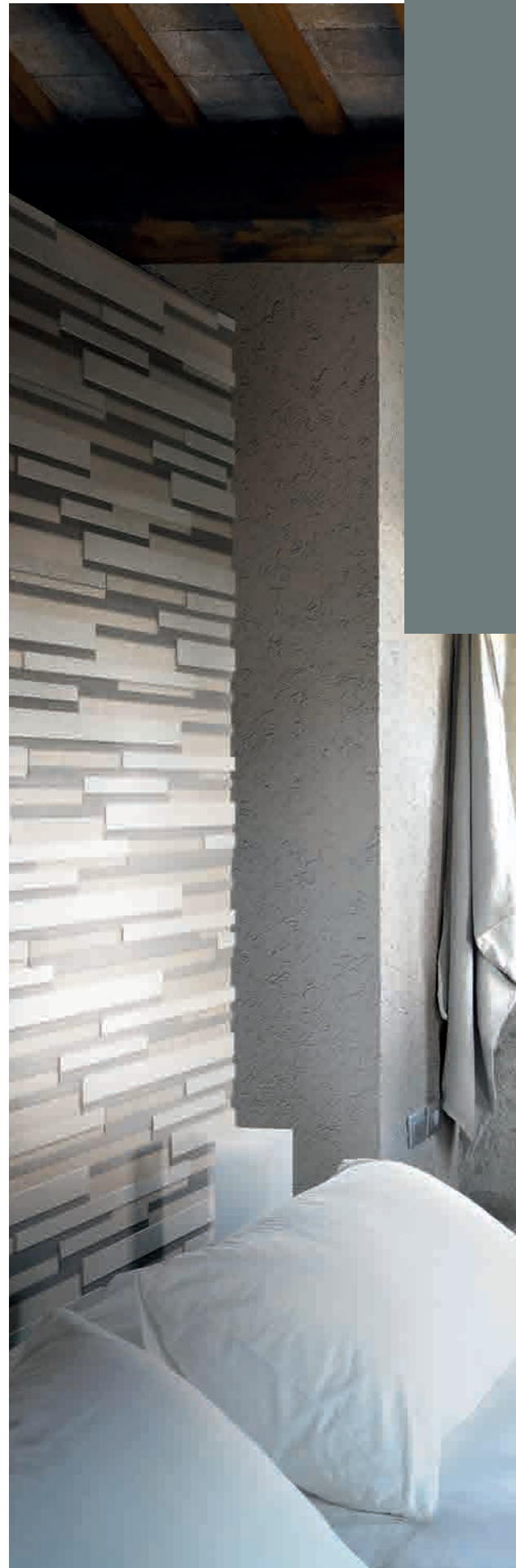

# INDUSTRIAL

gres fine porcellanato  
fine porcelain stoneware  
grès cérame fin  
feinsteinzeug-kollektionen  
gres porcelánico fino







## INDUSTRIAL

Modernità e semplicità caratterizzano questa superficie neutra e lineare che si esprime attraverso un mix di colori, formati e decori. **Industrial** si propone nella sua forma pura, per essere utilizzata in modo trasversale, efficace e accattivante in ogni progetto di architettura.

This neutral and linear surface is distinguished for being modern and simple, expressing itself through a mix of colours, sizes and decorations. **Industrial** presents itself in its purest form, to be used across the board, efficiently and captivately, in every architectural project.

Modernité et simplicité caractérisent cette surface neutre et linéaire qui s'exprime dans un mélange de coloris, de formats et de décors. Efficace et captivante dans tous les projets d'architecture, **Industrial** se propose dans sa forme pure pour être utilisée de façon transversale.

Modernität und Einfachheit kennzeichnen diese neutrale und lineare Oberfläche, die sich durch einen Mix aus Farben, Formaten und Dekoren ausdrückt. **Industrial** bietet sich in seiner puren Form an, um übergreifend, effizient und ansprechend in jedem Architekturprojekt verwendet werden zu können.

Esta superficie neutra y lineal, que se expresa a través de una mezcla de colores, formatos y decoraciones, se caracteriza por su gran modernidad y simplicidad. **Industrial** se propone en su forma pura, para ser usada transversalmente, eficaz y fascinante en cualquier proyecto de arquitectura.

# INDUSTRIAL

## IVORY



## TAUPE



**R10**  
**Classe B**  
(naturale)

**R9**  
**Classe A**  
(soft)

**R11**  
**Classe C**  
(bocciardato)

DCOF>  
0,42 Wet

**9 mm** 3/8" ↑↓



**R9**  
(matte)

**R10**  
**Classe B**  
(R+PTV)

DCOF>  
0,42 Wet

BS EN 16165  
ANNEX C  
>36 wet  
slider 96  
(R+PTV)

**6 mm** 1/4" ↑↓

FLORIM OVERSIZE  
**magnium**

### GRES FINE PORCELLANATO

FINE PORCELAIN STONEWARE / GRÈS CÉRAME FIN / FEINSTEINZEUG-KOLLEKTIONEN / GRES PORCELÁNICO FINO

SQUADRATO - SQUARED - EQUARRI - REKTIFIZIERT - ESCUADRADO

			9 mm 3/8" ↑↓		6 mm 1/4" ↑↓					
		COLOR	SURFACE	60x120 23 <sup>5/8"</sup> x47 <sup>1/4"</sup>	80x80 31 <sup>1/2"</sup> x31 <sup>1/2"</sup>	60x60 23 <sup>5/8"</sup> x23 <sup>5/8"</sup>	30x60 11 <sup>4/5"</sup> x23 <sup>5/8"</sup>	40x80 15 <sup>3/4"</sup> x31 <sup>1/2"</sup>	20x80 7 <sup>7/8"</sup> x31 <sup>1/2"</sup>	
INDUSTRIAL	IVORY	IVORY	NATURALE	738816 ■ FL-09100	738656 ■ FL-08100	738803 ■ FL-05800	738791 ■ FL-04900	738828 ■ FL-05800	738931 ■ FL-08400	
			SOFT	738822 ■ FL-09700	738662 ■ FL-08400	738810 ■ FL-06400	738797 ■ FL-05500	738834 ■ FL-06400	738937 ■ FL-09100	
			BOCCIARDATO	-	-	-	738955 ■ FL-05500	-	-	
	TAUPE	TAUPE	NATURALE	738819 ■ FL-09100	738659 ■ FL-08100	738807 ■ FL-05800	738794 ■ FL-04900	738831 ■ FL-05800	738934 ■ FL-08400	
			SOFT	738825 ■ FL-09700	738665 ■ FL-08400	738813 ■ FL-06400	738800 ■ FL-05500	738837 ■ FL-06400	738940 ■ FL-09100	
			BOCCIARDATO	-	-	-	738958 ■ FL-05500	-	-	
INDUSTRIAL	IVORY	IVORY	NATURALE	744351 ■ FL-14500	744393 ■ FL-11900	757774 ■ FL-10800	744399 ■ FL-09900	744405 ■ FL-08400	744381 ■ FL-07000	744411 ■ FL-07700
			R+PTV	-	-	-	758799 ■ FL-09900	757780 ■ FL-08400	-	-
	TAUPE	TAUPE	NATURALE	744352 ■ FL-14500	744394 ■ FL-11900	757775 ■ FL-10800	744400 ■ FL-09900	744406 ■ FL-08400	744382 ■ FL-07000	744412 ■ FL-07700
			R+PTV	-	-	-	758800 ■ FL-09900	757781 ■ FL-08400	-	-

## MOKA



## SAGE



**R10**  
**Classe B**  
(naturale)

**R9**  
**Classe A**  
(soft)

**R11**  
**Classe C**  
(bocciardato)

DCOF>  
0,42 Wet

9 mm 3/8" ↑↓



**R9**  
(matte)

**R10**  
**Classe B**  
(R+PTV)

DCOF>  
0,42 Wet

BS EN 16165  
ANNEX C  
>36 wet  
slider 96  
(R+PTV)

6 mm 1/4" ↑↓

FLOHM OVERSIZE  
magnUlm

**GRES FINE PORCELLANATO**  
FINE PORCELAIN STONEWARE / GRÈS CÉRAME FIN / FEINSTEINZEUG-KOLLEKTIONEN / GRES PORCELÁNICO FINO  
SQUADRATO - SQUARED - EQUARRI - REKTIFIZIERT - ESCUADRADO

9 mm 3/8" ↑↓		COLOR	SURFACE	60x120 23 <sup>5/8"</sup> x47 <sup>1/4"</sup>	80x80 31 <sup>1/2"</sup> x31 <sup>1/2"</sup>	60x60 23 <sup>5/8"</sup> x23 <sup>5/8"</sup>	30x60 11 <sup>4/5"</sup> x23 <sup>5/8"</sup>	40x80 15 <sup>3/4"</sup> x31 <sup>1/2"</sup>	20x80 7 <sup>7/8"</sup> x31 <sup>1/2"</sup>	
INDUSTRIAL	MOKA	NATURALE		738820 ■ FL-09100	738660 ■ FL-08100	738808 ■ FL-05800	738795 ■ FL-04900	738832 ■ FL-05800	738935 ■ FL-08400	
		SOFT		738826 ■ FL-09700	738666 ■ FL-08400	738814 ■ FL-06400	738801 ■ FL-05500	738838 ■ FL-06400	738941 ■ FL-09100	
		BOCCIARDATO		-	-	-	738959 ■ FL-05500	-	-	
	SAGE	NATURALE		738817 ■ FL-09100	738657 ■ FL-08100	738804 ■ FL-05800	738792 ■ FL-04900	738829 ■ FL-05800	738932 ■ FL-08400	
		SOFT		738823 ■ FL-09700	738663 ■ FL-08400	738811 ■ FL-06400	738798 ■ FL-05500	738835 ■ FL-06400	738938 ■ FL-09100	
		BOCCIARDATO		-	-	-	738956 ■ FL-05500	-	-	
6 mm 1/4" ↑↓		COLOR	SURFACE	160x320 63"x126"	160x160 63"x63"	120x280 47 <sup>1/4"</sup> x110 <sup>1/4"</sup>	120x240 47 <sup>1/4"</sup> x94 <sup>1/2"</sup>	120x120 47 <sup>1/4"</sup> x47 <sup>1/4"</sup>	80x80 31 <sup>1/2"</sup> x31 <sup>1/2"</sup>	60x120 23 <sup>5/8"</sup> x47 <sup>1/4"</sup>
INDUSTRIAL	MOKA	NATURALE		744354 ■ FL-14500	744396 ■ FL-11900	757776 ■ FL-10800	744402 ■ FL-09900	744408 ■ FL-08400	744384 ■ FL-07000	744414 ■ FL-07700
		R+PTV		-	-	-	758801 ■ FL-09900	757782 ■ FL-08400	-	-
	SAGE	NATURALE		744353 ■ FL-14500	744395 ■ FL-11900	757777 ■ FL-10800	744401 ■ FL-09900	744407 ■ FL-08400	744383 ■ FL-07000	744413 ■ FL-07700
		R+PTV		-	-	-	758802 ■ FL-09900	757783 ■ FL-08400	-	-



# INDUSTRIAL

## STEEL

## PLOMB



**R10**  
**Classe B**  
(naturale)

**R9**  
**Classe A**  
(soft)

**R11**  
**Classe C**  
(bocciardato)

DCOF>  
0,42 Wet

9 mm 3/8" ↑↓



**R9**  
(matte)

**R10**  
**Classe B**  
(R+PTV)

DCOF>  
0,42 Wet

BS EN 16165  
ANNEX C  
>36 wet  
slider 96  
(R+PTV)

6 mm 1/4" ↑↓

FLORIM OVERSIZE  
**magnium**

### GRES FINE PORCELLANATO

FINE PORCELAIN STONEWARE / GRÈS CÉRAME FIN / FEINSTEINZEUG-KOLLEKTIONEN / GRES PORCELÁNICO FINO

SQUADRATO - SQUARED - EQUARRI - REKTIFIZIERT - ESCUADRADO

9 mm 3/8" ↑↓		COLOR	SURFACE	60x120 23 <sup>5/8</sup> "x47 <sup>1/4</sup> "	80x80 31 <sup>1/2</sup> "x31 <sup>1/2</sup> "	60x60 23 <sup>5/8</sup> "x23 <sup>5/8</sup> "	30x60 11 <sup>4/5</sup> "x23 <sup>5/8</sup> "	40x80 15 <sup>3/4</sup> "x31 <sup>1/2</sup> "	20x80 7 <sup>7/8</sup> "x31 <sup>1/2</sup> "	
INDUSTRIAL	STEEL	NATURALE		738818 ■ FL-09100	738658 ■ FL-08100	738806 ■ FL-05800	738793 ■ FL-04900	738830 ■ FL-05800	738933 ■ FL-08400	
		SOFT		738824 ■ FL-09700	738664 ■ FL-08400	738812 ■ FL-06400	738799 ■ FL-05500	738836 ■ FL-06400	738939 ■ FL-09100	
		BOCCIARDATO		-	-	-	738957 ■ FL-05500	-	-	
	PLOMB	NATURALE		738821 ■ FL-09100	738661 ■ FL-08100	738809 ■ FL-05800	738796 ■ FL-04900	738833 ■ FL-05800	738936 ■ FL-08400	
		SOFT		738827 ■ FL-09700	738667 ■ FL-08400	738815 ■ FL-06400	738802 ■ FL-05500	738839 ■ FL-06400	738942 ■ FL-09100	
		BOCCIARDATO		-	-	-	738960 ■ FL-05500	-	-	
6 mm 1/4" ↑↓		COLOR	SURFACE	160x320 63"x126"	160x160 63"x63"	120x280 47 <sup>1/4</sup> "x110 <sup>1/4</sup> "	120x240 47 <sup>1/4</sup> "x94 <sup>1/2</sup> "	120x120 47 <sup>1/4</sup> "x47 <sup>1/4</sup> "	80x80 31 <sup>1/2</sup> "x31 <sup>1/2</sup> "	60x120 23 <sup>5/8</sup> "x47 <sup>1/4</sup> "
INDUSTRIAL	STEEL	NATURALE		744350 ■ FL-14500	744392 ■ FL-11900	757778 ■ FL-10800	744398 ■ FL-09900	744404 ■ FL-08400	744380 ■ FL-07000	744410 ■ FL-07700
		R+PTV		-	-	-	758803 ■ FL-09900	757784 ■ FL-08400	-	-
	PLOMB	NATURALE		744355 ■ FL-14500	744397 ■ FL-11900	757779 ■ FL-10800	744403 ■ FL-09900	744409 ■ FL-08400	744385 ■ FL-07000	744415 ■ FL-07700
		R+PTV		-	-	-	758804 ■ FL-09900	757785 ■ FL-08400	-	-

9 mm 3/8" ↑↓

COLOR

SURFACE

**30x30**  
11 4/5" x 11 4/5"  
pz/box 4

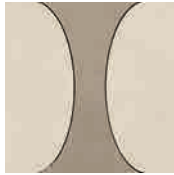

DECORO A  
TAUPE / IVORY

SOFT

739434  
▲ FL-03800

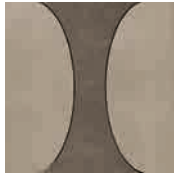

DECORO A  
MOKA / TAUPE

SOFT

739436  
▲ FL-03800

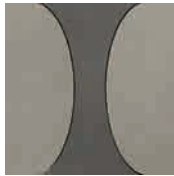

DECORO A  
PLOMB / STEEL

SOFT

739437  
▲ FL-03800

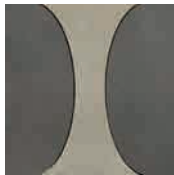

DECORO A  
SAGE / PLOMB

SOFT

739435  
▲ FL-03800

## INDUSTRIAL



DECORO B  
TAUPE / IVORY

SOFT

739438  
▲ FL-03800



DECORO B  
MOKA / TAUPE

SOFT

739440  
▲ FL-03800



DECORO B  
PLOMB / STEEL

SOFT

739441  
▲ FL-03800



DECORO B  
SAGE / PLOMB

SOFT

739439  
▲ FL-03800

# INDUSTRIAL

## PUZZLE DECOR

La fuga diventa decoro, la separazione della materia acquista una nuova espressività grazie alla tecnologia dell'idrogetto. Ogni realizzazione può essere unica e personalizzata in base allo spazio in cui dovrà essere inserita, il decoro può essere adattato a qualsiasi misura richiesta. Fuga tra i pezzi 1 mm. Per la realizzazione del progetto serve la pianta del cliente con indicazione precisa delle misure delle pareti da rivestire. Nel caso in cui non ci siano pareti perfettamente in squadra i pezzi ai lati saranno lasciati più lunghi di 5 cm.

Joint spaces become part of the decoration. The space that separates the material acquires a new level of expression thanks to water-jet technology. Each project can be unique and customised based on the area where it will be installed. The decoration can be adapted to any requested measurements. 1 mm joint space between tiles. The customer's floor plan is required to design the project, providing the precise measurements of the walls where the material will be applied. If the walls are not perfectly square, the side pieces must be left 5 cm longer.

Le joint devient une décoration, la séparation de la matière acquiert une nouvelle expressivité grâce à la technologie de l'hydrojet. Toutes les réalisations peuvent être uniques et personnalisées selon l'espace où elles devront être insérées, la décoration peut être adaptée à toute mesure demandée. Joint entre les pièces 1 mm. Pour la réalisation du projet, il faut le plan du client avec l'indication précise des mesures des murs à couvrir. Au cas où les murs ne seraient pas parfaitement en équerre, les pièces sur les côtés seront laissées plus longues de 5 cm.

Die Fuge wird zum Dekor; die Trennung der Materie erlangt dank der Wasserstrahltechnologie eine neue Ausdruckskraft. Jede Umsetzung kann einzigartig sein und je nach Raum, in den sie eingefügt werden soll, personalisiert werden. Das Dekor kann jeder gewünschten Größe angepasst werden. Fuge zwischen den Teilen 1 mm. Zur Umsetzung des Projekts wird der Plan des Kunden mit genauer Angabe der Maße der zu verkleidenden Wand benötigt. Im Falle von nicht perfekt quadratischen Wänden werden die an den Seiten befindlichen Teile 5 cm länger gelassen.

La junta se vuelve decoración, la separación de la materia adquiere una nueva expresión gracias a la tecnología de la propulsión por chorro de agua. Toda realización puede ser única y personalizada en base al espacio en el que se deberá colocar, la decoración se puede adaptar a cualquier medida requerida. Junta entre las piezas de 1 mm. Para llevar a cabo el proyecto es necesario contar con la planta del cliente, que indica con precisión las medidas de las paredes que hay que revestir. En el caso en el que no se cuente con paredes perfectamente en ángulo agudo, las piezas de los lados tendrán una longitud superior a los 5 cm.

PUZZLE DECOR 739829 ■ FL-51500

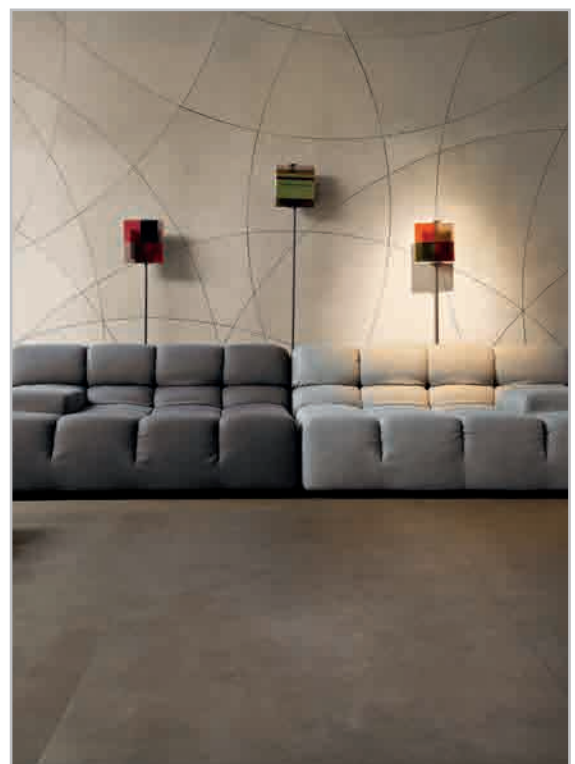
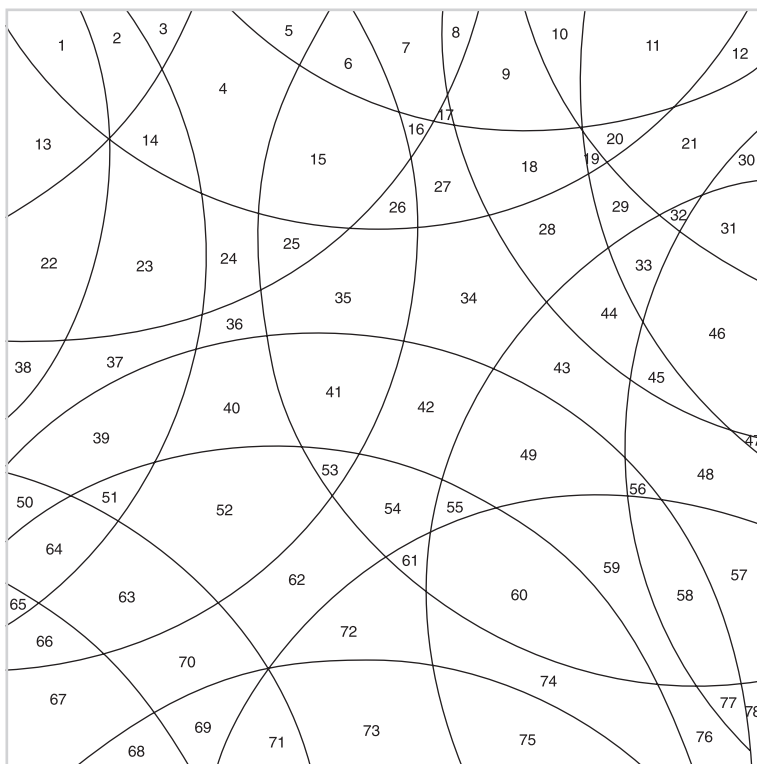

Esempio: per la realizzazione di un pannello di 160x160 cm il consumo sarà di 6 pezzi nel formato 80x80.









Example: covering a 160x160 cm panel will require the use of six 80x80 pieces.

Exemple: pour la réalisation d'un panneau de 160x160 cm, on consommera 6 pièces au format 80x80.











Beispiel: Zur Fertigung einer Platte von 160x160 cm liegt der Verbrauch bei 6 Teilen im Format 80x80.

Ejemplo: para la realización de un panel de 160x160 cm el consumo será de 6 piezas en el formato 80x80.

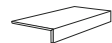
# Architectural design

9 mm 3/8" ↑↓		COLOR	SURFACE	<b>30x30</b> 1 1/4" x 1 1/4"  mosaico tessere 3x3	<b>15x60</b> 6" x 2 3/8"  modulo listello mix 3D soft pz/box 6
<b>INDUSTRIAL</b>		IVORY	NATURALE	739130 ■ FL-15600	SAGE-PLOMB-STEEL
		TAUPE	NATURALE	739133 ■ FL-15600	739190 ▲ FL-03600
		MOKA	NATURALE	739134 ■ FL-15600	IVORY-MOKA-TAUPE
		SAGE	NATURALE	739131 ■ FL-15600	739191 ▲ FL-03600
		STEEL	NATURALE	739132 ■ FL-15600	
		PLOMB	NATURALE	739135 ■ FL-15600	

## PEZZI SPECIALI/SPECIAL TRIMS/PIÈCES SPÉCIALES/FORMSTÜCKE/PIEZAS ESPECIALES

9 mm 3/8" ↑↓		COLOR	SURFACE	<b>4,6x60</b> 1 4/5" x 2 3/8"  battiscopa	<b>33x120x3</b> 13" x 4 7/8" x 1 1/8"  gradino pz/box 2	<b>33x120x3</b> 13" x 4 7/8" x 1 1/8"  angolo gradino dx pz/box 2	<b>33x120x3</b> 13" x 4 7/8" x 1 1/8"  angolo gradino sx pz/box 2	<b>33x120x3</b> 13" x 4 7/8" x 1 1/8"  angolo gradino dx/sx pz/box 1	<b>15x60x6</b> 6" x 2 3/8" x 2 1/8"  elemento elle pz/box 4
<b>INDUSTRIAL</b>		IVORY	NATURALE	745535 ◆ FL-01600	739142 ▲ FL-20400	739148 ▲ FL-31100	739154 ▲ FL-31100	739422 ▲ FL-42900	-
			SOFT	745541 ◆ FL-01600	739160 ▲ FL-20400	739166 ▲ FL-31100	739172 ▲ FL-31100	739428 ▲ FL-42900	-
			BOCCIARDATO	-	-	-	-	-	739136 ▲ FL-03600
		TAUPE	NATURALE	745540 ◆ FL-01600	739145 ▲ FL-20400	739151 ▲ FL-31100	739157 ▲ FL-31100	739425 ▲ FL-42900	-
			SOFT	745546 ◆ FL-01600	739163 ▲ FL-20400	739169 ▲ FL-31100	739175 ▲ FL-31100	739431 ▲ FL-42900	-
			BOCCIARDATO	-	-	-	-	-	739139 ▲ FL-03600
		MOKA	NATURALE	745536 ◆ FL-01600	739146 ▲ FL-20400	739152 ▲ FL-31100	739158 ▲ FL-31100	739426 ▲ FL-42900	-
			SOFT	745542 ◆ FL-01600	739164 ▲ FL-20400	739170 ▲ FL-31100	739176 ▲ FL-31100	739432 ▲ FL-42900	-
			BOCCIARDATO	-	-	-	-	-	739140 ▲ FL-03600
		SAGE	NATURALE	745538 ◆ FL-01600	739143 ▲ FL-20400	739149 ▲ FL-31100	739155 ▲ FL-31100	739423 ▲ FL-42900	-
			SOFT	745544 ◆ FL-01600	739161 ▲ FL-20400	739167 ▲ FL-31100	739173 ▲ FL-31100	739429 ▲ FL-42900	-
			BOCCIARDATO	-	-	-	-	-	739137 ▲ FL-03600
		STEEL	NATURALE	745539 ◆ FL-01600	739144 ▲ FL-20400	739150 ▲ FL-31100	739156 ▲ FL-31100	739424 ▲ FL-42900	-
			SOFT	745545 ◆ FL-01600	739162 ▲ FL-20400	739168 ▲ FL-31100	739174 ▲ FL-31100	739430 ▲ FL-42900	-
			BOCCIARDATO	-	-	-	-	-	739138 ▲ FL-03600
		PLOMB	NATURALE	745537 ◆ FL-01600	739147 ▲ FL-20400	739153 ▲ FL-31100	739159 ▲ FL-31100	739427 ▲ FL-42900	-
			SOFT	745543 ◆ FL-01600	739165 ▲ FL-20400	739171 ▲ FL-31100	739177 ▲ FL-31100	739433 ▲ FL-42900	-
			BOCCIARDATO	-	-	-	-	-	739141 ▲ FL-03600



# INDUSTRIAL

PEZZI SPECIALI/SPECIAL TRIMS  
PIÈCES SPÉCIALES/FORMSTÜCKE  
PIEZAS ESPECIALES

6 mm 1/4" ↑	COLOR	SURFACE	30x30 11 4/5" x 11 4/5"	30x30 11 4/5" x 11 4/5"	30x30 11 4/5" x 11 4/5"	4,6x80 1 4/5" x 3 1/2"
			mosaico tessere 7,5x7,5 pz/box 11	muretto tessere 7,5x15 pz/box 11	mosaico tessere 1,5x3 pz/box 11	battiscopa
INDUSTRIAL	IVORY	NATURALE	747722 ▲ FL-01800	747732 ▲ FL-01800	747742 ▲ FL-02700	747857 ◆ FL-01800
	TAUPE	NATURALE	747723 ▲ FL-01800	747733 ▲ FL-01800	747743 ▲ FL-02700	747858 ◆ FL-01800
	MOKA	NATURALE	747724 ▲ FL-01800	747734 ▲ FL-01800	747744 ▲ FL-02700	747859 ◆ FL-01800
	SAGE	NATURALE	747725 ▲ FL-01800	747735 ▲ FL-01800	747745 ▲ FL-02700	747860 ◆ FL-01800
	STEEL	NATURALE	747726 ▲ FL-01800	747736 ▲ FL-01800	747746 ▲ FL-02700	747861 ◆ FL-01800
	PLOMB	NATURALE	747727 ▲ FL-01800	747737 ▲ FL-01800	747747 ▲ FL-02700	747862 ◆ FL-01800



FLORIM OVERSIZE  
**magnUm**

**160x320/160x160/120x280/120x240  
120x120/80x80/60x120**

Specifica Imballo pag.  
Packaging specifications on page  
Spécifications d'emballage à page  
Verpackungsdetail Seite  
Especificaciones de embalaje a la página  
**194/195**

INDUSTRIAL	scatola - box			pallet		
	pz	mq	kg	box	mq	kg
60x120	2	1,44	28,08	30	43,20	870
80x80	2	1,28	24,96	40	51,20	1030
40x80	3	0,96	18,53	56	53,76	1070
60x60	3	1,08	21,06	40	43,20	870
30x60	6	1,08	20,84	40	43,20	860
20x80	6	0,96	21,41	48	46,08	1060
30x30 mosaico	11	1,00	23,20	30	30,00	730
puzzle decor	1	1,00	23,40	6	6,00	170

**I formati 160x160 e 80x240 posso essere acquistati solo a multipli di 2 lastre.** / Sales unit for 160x160 and 80x240 is 2 pcs, so they can only be bought in multiples of 2. / Les formats 160x160 et 80x240 sont vendus par multiples de 2 plaques / Die Formate 160x160 und 80x240 können nur in einer durch 2 teilbaren Anzahl bestellt werden / Las medidas 160x160 y 80x240 solo pueden comprarse en múltiplos de 2 placas.

**Per un effetto ottimale della posa, Florim suggerisce di mantenere 2 mm di fuga per pose monoformato e 3 mm per combinare formati misti.** - For optimal installation results, Florim recommends maintaining a joint of 2 mm - 1/16" for single format installations and 3 mm - 1/8" to combine mixed formats. - Pour réaliser une pose parfait, Florim conseille de laisser 2 mm de joint pour la pose des monoformats et 3 mm pour les combinaisons de formats mixtes. - Um einen optimalen effekt beim verlegen zu erzielen empfiehlt Florim eine 2 mm fugen bei einformatigen verlegungen und 3 mm fugen bei formatkombinationen - Para lograr los máximos resultados en la posa del producto, Florim aconseja 2 mm de junta en aplicaciones monoformato y 3 mm en combinaciones de formatos mixtos.

INDUSTRIAL	scatola - box			pallet		
	pz	ml	kg	box	mq	kg
4,6x60 battiscopa	14	8,40	8,40	-	-	-

**In relazione alle differenti tecnologie produttive l'accostamento di prodotti con spessori diversi potrebbe presentare delle disomogeneità, se ne sconsiglia pertanto l'abbinamento.** / Due to the different production technologies, contiguous installation of products with different thickness may give a non-homogeneous result. For this reason we do not recommend this option. / Vu que différentes technologies de production sont utilisées avec des épaisseurs différentes, des problèmes d'homogénéité pourraient se présenter, il est donc déconseillé de les poser ensemble. / Wegen unterschiedlicher Produktionstechnologien können die Fliesen mit verschiedenen Materialstärken optische Differenzen aufweisen. Von einem direkten Aneinanderlegen wird deshalb abgeraten. / Dadas las diferentes tecnologías productivas, la combinación de productos de diferentes espesores podría dar lugar a heterogeneidad, por lo que se desaconseja mezclarlas.



# INDUSTRIAL OUTDOOR

## Vantaggi tecnici - Technical advantages - Avantages techniques Technische Vorteile - Ventajas técnicas

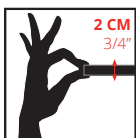

- Lastra monolitica compatta di spessore 2 cm squadrata e rettificata
- Compact monolithic slab 2 cm thick squared and rectified
- Dalle monolithique compacte de 2 cm d'épaisseur, équarrie et rectifiée
- Kompakte monolithische Platte, 2 cm dick, rechteckig und scharfkantig geschliffen
- Losa monolítica compacta de 2 cm de espesor, escuadrada y rectificada.

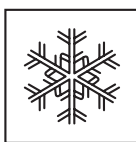

- INGELIVO
- FROST RESISTANT
- INGÉLIF
- FROSTBESTÄNDIG
- RESISTENTE A LA HELADA



- ELEVATA RESISTENZA AI CARICHI STATICI
- HIGH STATIC LOAD RESISTANCE
- RÉSISTANCE ÉLEVÉE AUX CHARGES STATIQUES
- HOHE STATISCHE BELASTBARKEIT
- ELEVADA RESISTENCIA A LAS CARGAS ESTÁTICAS



- FACILE DA POSARE
- EASY TO INSTALL
- FACILE À POSER
- VERLEGELEICHT
- FÁCIL DE COLOCAR



- ANTISCIVOLO R11
- ANTI SLIP R11
- ANTIDÉRAPANT R11
- RUTSCHFEST R11
- ANTIDESLIZANTE R11

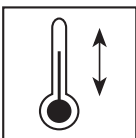

- RESISTENTE AGLI SBALZI TERMICI
- THERMAL SHOCK RESISTANT
- RÉSISTANT AUX ÉCARTS THERMIQUES
- TEMPERATURWECHSELBESTÄNDIG
- RESISTENTE A LAS OSCILACIONES TÉRMICAS



- FACILE DA PULIRE
- EASY TO CLEAN
- FACILE À NETTOYER
- REINIGUNGSLEICHT
- FÁCIL DE LIMPIAR

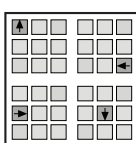

- RIMOVIBILE E RIUTILIZZABILE
- REMOVABLE AND REUSABLE
- DÉMONTABLE ET RÉUTILISABLE
- ENTFERNBAR UND WIEDERVERWENDBAR
- DESMONTABLE Y REUTILIZABLE



- INATTACCABILE DA AGENTI CHIMICI E MUFFE
- IMPERVIOUS TO ATTACK BY CHEMICALS OR MOULD
- RÉSISTANT AUX AGENTS CHIMIQUES ET AUX MOISSISSURES
- UNANGREIFBAR DURCH CHEMISCHE STOFFE UND SCHIMMEL
- RESISTENTE A LOS AGENTES QUÍMICOS Y A LOS MOHOS

## Applicazioni - Applications - Applications - Verlegung - Aplicaciones

- Posa diretta su erba
- Direct installation on grass
- Pose directe sur de l'herbe
- Verlegung direkt auf Rasen
- Colocación directa sobre hierba

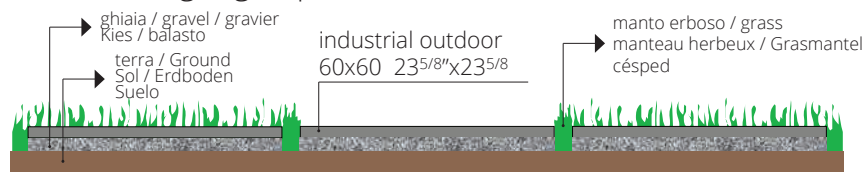

- Posa diretta su ghiaia
- Direct installation over gravel
- Pose direct sur du gravier
- Verlegung direkt auf Kies
- Colocación directa sobre grava



- Posa su massetto cementizio
- Installation on sand-cement screed
- Pose sur chape ciment
- Verlegung auf Zement-Unterbetonblock
- Colocación sobre contrapiso de hormigón

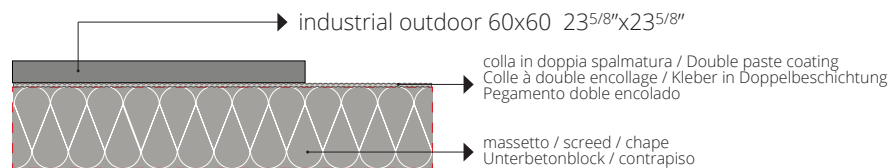

- Posa su piedini fissi o regolabili
- Installation on fixed or adjustable feet
- Pose sur pieds fixes ou réglables
- Verlegung auf feststehende oder regulierbare Füße
- Colocación sobre pies fijos o regulables

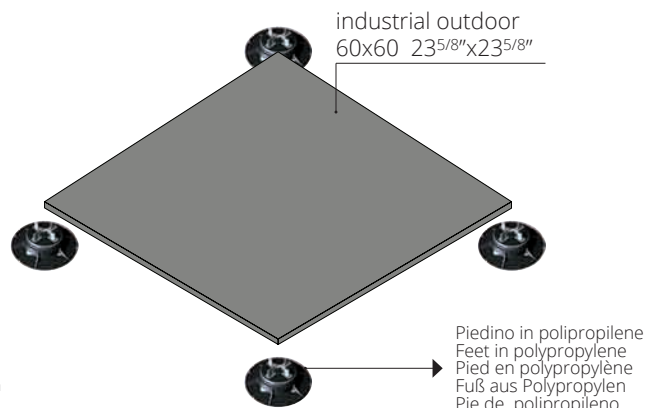

Per le specifiche di utilizzo dei sistemi sopraelevati vedi il sito [florim.com](http://florim.com)  
For the specifics on use of raised systems visit the site [florim.com](http://florim.com)  
Pour les caractéristiques d'utilisation des systèmes surélevés, voir le site [florim.com](http://florim.com)  
Für die Nutzungsbedingungen der Doppelbodensysteme siehe Webseite [florim.com](http://florim.com)  
Para las especificaciones de empleo de los sistemas sobreelevados consulte el sitio web [florim.com](http://florim.com)

Le lastre ceramiche sono sottoposte a un trattamento di compattazione termica che assicura resistenza e durata nel tempo. Il bassissimo assorbimento d'acqua rende perciò il materiale ingelivo. Ciò può comportare ristagni d'acqua superficiali anche per materiale installato a regola d'arte. / Ceramic tiles undergo a compacting thermal treatment that ensures resistance and durability. The low level of water absorption makes the slabs frost resistant. This could result in superficial water stagnations even if materials are installed in a workmanlike manner. / Les carreaux de céramique subissent un traitement thermique de compactage qui assure résistance et durabilité. Le faible niveau d'absorption d'eau rend les dalles résistantes au gel. Il pourrait en résulter des stagnations d'eau superficielles, même si les dalles ont été installées dans les règles de l'art. / Die Keramikplatten werden einer thermischen Verdichtung unterzogen, welche die Widerstandsfähigkeit und Langlebigkeit sichert. Die extrem niedrige Wasseraufnahme macht das Material frostsicher. Die hohe Materialdichte kann, auch bei einer perfekten Verlegung, eine längere Abtrochnungszeit von angestaumtem Wasser zur Folge haben. / Las baldosas cerámicas se someten a un tratamiento de compactación térmica que asegura resistencia y durabilidad. La baja absorción de agua hace que las baldosas resistan al hielo. Esto podría resultar en estancamientos superficiales de agua, incluso si los materiales están instalados según las reglas del arte.

## IVORY



## TAUPE

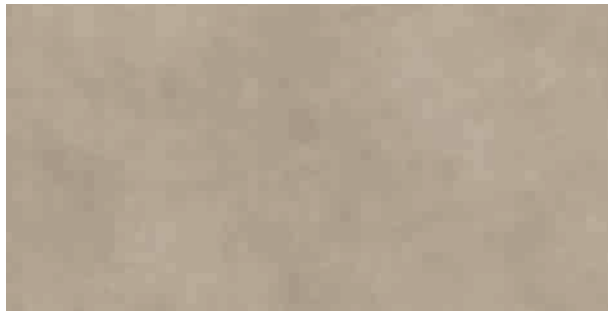

**R11**  
CLASSE C

DCOF >  
0,42 Wet

20 mm 3/4" ↑↓

## MOKA

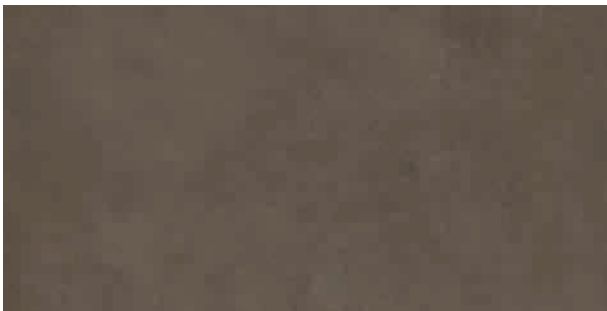

## SAGE



## STEEL

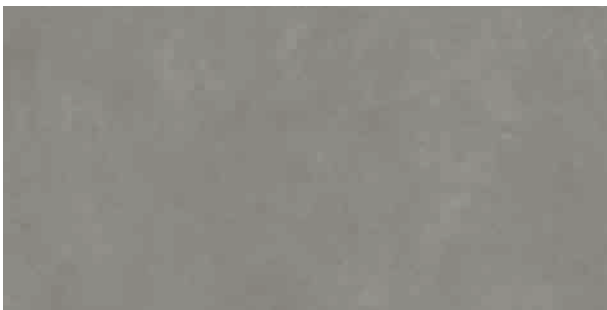

## PLOMB



**GRES FINE PORCELLANATO**  
FINE PORCELAIN STONWARE/GRES CERAME FIN/FEINSTEINZEUG-KOLLEKTIONEN/GRES PORCELANICO FINO  
SQUADRATO - SQUARED - EQUARRI - REKTIFIZIERT - ESCUADRADO

20 mm 3/4" ↑↓

	COLOR	SURFACE	60x60 23 <sup>5/8</sup> "x23 <sup>5/8</sup> "
<b>INDUSTRIAL</b>	IVORY	BOCCIARDATO	738961 ■ FL-09300
	TAUPE	BOCCIARDATO	738964 ■ FL-09300
	MOKA	BOCCIARDATO	738965 ■ FL-09300
	SAGE	BOCCIARDATO	738962 ■ FL-09300
	STEEL	BOCCIARDATO	738963 ■ FL-09300
	PLOMB	BOCCIARDATO	738966 ■ FL-09300



Recycled material content certification

20mm  
STEEL - SAGE

ISO 10545-4	RESISTENZA ALLA FLESSIONE IN N/mm <sup>2</sup> N/mm <sup>2</sup> FLEXURAL STRENGTH TEST / RESISTANCE A LA FLEXION EN N/mm <sup>2</sup> / BIEGEFESTIGKEIT IN N/mm <sup>2</sup> / RESISTENCIA A LA FLEXION EN N/mm <sup>2</sup>	valore medio 52 N/mm <sup>2</sup>
	Forza di rottura in N (sp. > 7,5 mm) Breaking strength in N (thickness > 7,5 mm) / Forza de ruptura en N (es. > 7,5 mm) / Bruchlast in N (Dicke > 7,5 mm) / Fuerza de rotura en N (gr. > 7,5 mm)	valore medio 14000 N

**PEZZI SPECIALI**  
Special trims/Pièces spéciales/Formstücke  
Piezas especiales  
pag 184/185

INDUSTRIAL	scatola - box			pallet		
	pz	mq	kg	box	mq	kg
60x60 20mm	2	0,72	32,15	30	21,60	990







# PLIMATECH

gres fine porcellanato  
fine porcelain stoneware  
grès cérame fin  
feinsteinzeug-kollektionen  
gres porcelánico fino







## PLIMATECH

La naturalità del granito Plima si unisce alla versatilità del gres porcellanato Florim. Dalle alture della Val Martello in Alto Adige nasce l'ispirazione di **Plimatech** dell'Architectural design. Modellata su una varietà di granito chiamato Plima, la collezione unisce ai vantaggi tecnico-progettuali del gres porcellanato l'aspetto naturale e la struttura di una pietra estremamente rara dalla particolare texture mossa con brillanti formazioni cristalline e screziature chiaro-scure. Plimatech presenta tre differenti colorazioni aggiungendo alla tipica tonalità grigio-azzurra del granito Plima altre due proposte cromatiche, una sui toni del bianco e l'altra su quelli del beige. L'eterogeneità estetica caratteristica della pietra naturale viene reinterpretata attraverso tre varianti grafiche con diversi gradi di stonizzazione.

The naturalness of Plima granite combines with the versatility of Florim porcelain stoneware. The inspiration for **Plimatech** Architectural design comes from high up in the Martell Valley of the Alto Adige region. Modeled on a variety of granite called Plima, the collection combines the technical and design advantages of porcelain stoneware, and the natural appearance and structure of an extremely rare stone featuring a distinctive wavy texture, with brilliant crystal formations and light-dark mottling. Plimatech comes in three different colors, adding two more schemes to the typical gray-blue shade of Plima granite, one in white, the other in beige. The aesthetic heterogeneity characteristic of natural stone is reinterpreted through three graphic variants with different degrees of tonal variation.

Le naturel du granit Plima se marie à la polyvalence du grès cérame Florim. **Plimatech** de l'Architectural design puise son inspiration dans les hauteurs du Val Martello dans le Haut-Adige. Façonnée à partir d'une variété de granit appelée Plima, la collection allie les avantages techniques et conceptuels du grès cérame à l'aspect naturel et à la structure d'une pierre extrêmement rare, à la texture particulière, ondulée et agrémentée de formations cristallines brillantes et de marbrures claires et sombres. Plimatech présente trois couleurs différentes : deux propositions chromatiques, l'une avec des tonalités blanches et l'autre avec des nuances beiges, s'ajoutent au ton caractéristique gris-bleu ciel du granit Plima. L'hétérogénéité esthétique qui distingue la pierre naturelle est réinterprétée à travers trois variantes graphiques offrant différents niveaux de stonisation.

Die Natürlichkeit des Granits Plima verbindet sich mit der Vielseitigkeit des Feinsteinzeugs Florim. Aus den Höhen des Martelltals in Südtirol kommt die Inspiration für **Plimatech** Architectural Design. Die einer Granitart namens Plima nachempfundene Kollektion verbindet die technischen und gestalterischen Vorteile von Feinsteinzeug mit dem natürlichen Aussehen und der Struktur eines seltenen Gesteins, das sich durch eine unverwechselbare gewellte Textur mit glänzenden Kristallformationen und Hell-Dunkel-Sprenkeln auszeichnet. Plimatech ist in drei verschiedenen Farben erhältlich, wobei zum typischen graublauen Farbton des Plima-Granits zwei weitere Schattierungen hinzukommen, eine in Weiß- und eine in Beigetönen. Die für Naturstein charakteristische ästhetische Heterogenität wird durch drei grafische Varianten mit unterschiedlichen Schattierungsgraden neu interpretiert.

La naturalidad del granito Plima se une a la versatilidad del gres porcelánico Florim. La inspiración de **Plimatech** de Architectural design tiene su origen en las alturas de Val Martello, en Alto Adigio. Modelada en una variedad de granito llamada Plima, la colección aúna las ventajas técnico-proyectuales del gres porcelánico y la estructura y el aspecto natural de una piedra sumamente peculiar, dotada de una textura especial y animada con brillantes formaciones cristalinias y venas claroscúras. Plimatech presenta tres colores distintos, añadiendo otras dos propuestas cromáticas a la típica tonalidad gris-celeste del granito Plima: una en tonos blancos y otra en gradaciones beige. La heterogeneidad estética característica de la piedra natural se reinterpreta a través de tres variantes gráficas con diferentes grados de destonización.



## PLIMAWHITE/01



## PLIMAWHITE/02



**R10**  
**Classe B**  
(naturale/  
matte)

BS EN 16165  
ANNEX C  
>36 wet  
slider 96  
(naturale/  
matte)

**R11**  
**Classe C**  
(strutturato)

DCOF>  
0,42 Wet

9 mm 3/8" ↑↓



**R10**  
**Classe B**

BS EN 16165  
ANNEX C  
>36 wet  
slider 96

DCOF>  
0,42 Wet

6 mm 1/4" ↑↓

FLORIM OVERSIZE  
**magnum**

**GRES FINE PORCELLANATO**  
FINE PORCELAIN STONEWARE / GRÈS CÉRAME FIN / FEINSTEINZEUG-KOLLEKTIONEN / GRES PORCELÁNICO FINO  
SQUADRATO - SQUARED - EQUARRI - REKTIFIZIERT - ESCUADRADO

9 mm 3/8" ↑↓		COLOR	SURFACE	60x120 23 <sup>5/8"</sup> x47 <sup>1/4"</sup>	60x60 23 <sup>5/8"</sup> x23 <sup>5/8"</sup>	30x60 11 <sup>4/5"</sup> x23 <sup>5/8"</sup>	
<b>PLIMATECH</b>		PLIMAWHITE/01	NATURALE/MATTE	776566 ■ FL-09100	776506 ■ FL-05800	776496 ■ FL-05800	
			STRUTTURATO	776658 ■ FL-09100	-	-	
		PLIMAWHITE/02	NATURALE/MATTE	776569 ■ FL-09100	776507 ■ FL-05800	776497 ■ FL-05800	
			STRUTTURATO	776659 ■ FL-09100	-	-	
6 mm 1/4" ↑↓		COLOR	SURFACE	120x280 47 <sup>1/4"</sup> x110 <sup>1/4"</sup>	120x240 47 <sup>1/4"</sup> x94 <sup>1/2"</sup>	120x120 47 <sup>1/4"</sup> x47 <sup>1/4"</sup>	60x120 23 <sup>5/8"</sup> x47 <sup>1/4"</sup>
<b>PLIMATECH</b>		PLIMAWHITE/01	NATURALE/MATTE	776410 ■ FL-10800	776549 ■ FL-09900	776558 ■ FL-08400	776577 ■ FL-07700
				PLIMAWHITE/02	NATURALE/MATTE	776412 ■ FL-10800	776550 ■ FL-09900

## PLIMAWHITE/03



**R10**  
**Classe B**  
(naturale/  
matte)

BS EN 16165  
ANNEX C  
>36 wet  
slider 96  
(naturale/  
matte)

**R11**  
**Classe C**  
(strutturato)

DCOF>  
0,42 Wet

9 mm 3/8" ↑↓



**R10**  
**Classe B**

BS EN 16165  
ANNEX C  
>36 wet  
slider 96

DCOF>  
0,42 Wet

6 mm 1/4" ↑↓

FLORIM OVERSIZE  
**magnum**

**GRES FINE PORCELLANATO**  
FINE PORCELAIN STONEWARE / GRÈS CÉRAMÉ FIN / FEINSTEINZEUG-KOLLEKTIONEN / GRES PORCELÁNICO FINO  
SQUADRATO - SQUARED - EQUARRI - REKTIFIZIERT - ESCUADRADO

9 mm 3/8" ↑↓		COLOR	SURFACE	60x120 23 <sup>5/8"</sup> x47 <sup>1/4"</sup>	60x60 23 <sup>5/8"</sup> x23 <sup>5/8"</sup>	30x60 11 <sup>4/5"</sup> x23 <sup>5/8"</sup>	
<b>PLIMATECH</b>		PLIMAWHITE/03	NATURALE/MATTE	776570 ■ FL-09100	776508 ■ FL-05800	776498 ■ FL-05800	
			STRUTTURATO	776660 ■ FL-09100	-	-	
6 mm 1/4" ↑↓		COLOR	SURFACE	120x280 47 <sup>1/4"</sup> x110 <sup>1/4"</sup>	120x240 47 <sup>1/4"</sup> x94 <sup>1/2"</sup>	120x120 47 <sup>1/4"</sup> x47 <sup>1/4"</sup>	60x120 23 <sup>5/8"</sup> x47 <sup>1/4"</sup>
<b>PLIMATECH</b>		PLIMAWHITE/03	NATURALE/MATTE	776413 ■ FL-10800	776551 ■ FL-09900	776560 ■ FL-08400	776579 ■ FL-07700



## PLIMABEIGE/01



## PLIMABEIGE/02



**R10**  
**Classe B**  
(naturale/  
matte)

BS EN 16165  
ANNEX C  
>36 wet  
slider 96  
(naturale/  
matte)

**R11**  
**Classe C**  
(strutturato)

DCOF>  
0,42 Wet

9 mm 3/8" ↑↓



**R10**  
**Classe B**

BS EN 16165  
ANNEX C  
>36 wet  
slider 96

DCOF>  
0,42 Wet

6 mm 1/4" ↑↓

FLORIM OVERSIZE  
**magnuM**

**GRES FINE PORCELLANATO**  
FINE PORCELAIN STONEWARE / GRÈS CÉRAME FIN / FEINSTEINZEUG-KOLLEKTIONEN / GRES PORCELÁNICO FINO  
SQUADRATO - SQUARED - EQUARRI - REKTIFIZIERT - ESCUADRADO

9 mm 3/8" ↑↓		COLOR	SURFACE	60x120 23 <sup>5/8"</sup> x47 <sup>1/4"</sup>	60x60 23 <sup>5/8"</sup> x23 <sup>5/8"</sup>	30x60 11 <sup>4/5"</sup> x23 <sup>5/8"</sup>	
<b>PLIMATECH</b>		PLIMABEIGE/01	NATURALE/MATTE	776571 ■ FL-09100	776509 ■ FL-05800	776499 ■ FL-05800	
			STRUTTURATO	776661 ■ FL-09100	-	-	
		PLIMABEIGE/02	NATURALE/MATTE	776572 ■ FL-09100	776510 ■ FL-05800	776500 ■ FL-05800	
			STRUTTURATO	776662 ■ FL-09100	-	-	
6 mm 1/4" ↑↓		COLOR	SURFACE	120x280 47 <sup>1/4"</sup> x110 <sup>1/4"</sup>	120x240 47 <sup>1/4"</sup> x94 <sup>1/2"</sup>	120x120 47 <sup>1/4"</sup> x47 <sup>1/4"</sup>	60x120 23 <sup>5/8"</sup> x47 <sup>1/4"</sup>
<b>PLIMATECH</b>		PLIMABEIGE/01	NATURALE/MATTE	776414 ■ FL-10800	776552 ■ FL-09900	776561 ■ FL-08400	776580 ■ FL-07700
				PLIMABEIGE/02	NATURALE/MATTE	776415 ■ FL-10800	776553 ■ FL-09900

## PLIMABEIGE/03



**R10**  
**Classe B**  
(naturale/  
matte)

BS EN 16165  
ANNEX C  
>36 wet  
slider 96  
(naturale/  
matte)

**R11**  
**Classe C**  
(strutturato)

DCOF>  
0,42 Wet

9 mm 3/8" ↑↓



**R10**  
**Classe B**



BS EN 16165  
ANNEX C  
>36 wet  
slider 96

DCOF>  
0,42 Wet

6 mm 1/4" ↑↓

FLORIM OVERSIZE  
**magnum**

**GRES FINE PORCELLANATO**  
FINE PORCELAIN STONEWARE / GRÈS CÉRAME FIN / FEINSTEINZEUG-KOLLEKTIONEN / GRES PORCELÁNICO FINO  
SQUADRATO - SQUARED - EQUARRI - REKTIFIZIERT - ESCUADRADO

9 mm 3/8" ↑↓		COLOR	SURFACE	60x120 23 <sup>5/8"</sup> x47 <sup>1/4"</sup>	60x60 23 <sup>5/8"</sup> x23 <sup>5/8"</sup>	30x60 11 <sup>4/5"</sup> x23 <sup>5/8"</sup>	
<b>PLIMATECH</b>		PLIMABEIGE/03	NATURALE/MATTE	776573 ■ FL-09100	776511 ■ FL-05800	776501 ■ FL-05800	
			STRUTTURATO	776663 ■ FL-09100	-	-	
6 mm 1/4" ↑↓		COLOR	SURFACE	120x280 47 <sup>1/4"</sup> x110 <sup>1/4"</sup>	120x240 47 <sup>1/4"</sup> x94 <sup>1/2"</sup>	120x120 47 <sup>1/4"</sup> x47 <sup>1/4"</sup>	60x120 23 <sup>5/8"</sup> x47 <sup>1/4"</sup>
<b>PLIMATECH</b>		PLIMABEIGE/03	NATURALE/MATTE	776416 ■ FL-10800	776554 ■ FL-09900	776563 ■ FL-08400	776582 ■ FL-07700



## PLIMAGRAY/01



## PLIMAGRAY/02



**R10**  
**Classe B**  
(naturale/  
matte)

BS EN 16165  
ANNEX C  
>36 wet  
slider 96  
(naturale/  
matte)

**R11**  
**Classe C**  
(strutturato)

DCOF>  
0,42 Wet

9 mm 3/8" ↑↓



**R10**  
**Classe B**

BS EN 16165  
ANNEX C  
>36 wet  
slider 96

DCOF>  
0,42 Wet

6 mm 1/4" ↑↓

FLORIM OVERSIZE  
**magnum**

**GRES FINE PORCELLANATO**  
FINE PORCELAIN STONEWARE / GRÈS CÉRAME FIN / FEINSTEINZEUG-KOLLEKTIONEN / GRES PORCELÁNICO FINO  
SQUADRATO - SQUARED - EQUARRI - REKTIFIZIERT - ESCUADRADO

9 mm 3/8" ↑↓		COLOR	SURFACE	60x120 23 <sup>5/8"</sup> x47 <sup>1/4"</sup>	60x60 23 <sup>5/8"</sup> x23 <sup>5/8"</sup>	30x60 11 <sup>4/5"</sup> x23 <sup>5/8"</sup>	
<b>PLIMATECH</b>		PLIMAGRAY/01	NATURALE/MATTE	776574 ■ FL-09100	776513 ■ FL-05800	776502 ■ FL-05800	
			STRUTTURATO	776664 ■ FL-09100	-	-	
		PLIMAGRAY/02	NATURALE/MATTE	776575 ■ FL-09100	776514 ■ FL-05800	776503 ■ FL-05800	
			STRUTTURATO	776665 ■ FL-09100	-	-	
6 mm 1/4" ↑↓		COLOR	SURFACE	120x280 47 <sup>1/4"</sup> x110 <sup>1/4"</sup>	120x240 47 <sup>1/4"</sup> x94 <sup>1/2"</sup>	120x120 47 <sup>1/4"</sup> x47 <sup>1/4"</sup>	60x120 23 <sup>5/8"</sup> x47 <sup>1/4"</sup>
<b>PLIMATECH</b>		PLIMAGRAY/01	NATURALE/MATTE	776417 ■ FL-10800	776555 ■ FL-09900	776565 ■ FL-08400	776583 ■ FL-07700
				PLIMAGRAY/02	NATURALE/MATTE	776418 ■ FL-10800	776556 ■ FL-09900

## PLIMAGRAY/03



**R10**  
**Classe B**  
(naturale/  
matte)

BS EN 16165  
ANNEX C  
>36 wet  
slider 96  
(naturale/  
matte)

**R11**  
**Classe C**  
(strutturato)

DCOF>  
0,42 Wet

9 mm 3/8" ↑↓



**R10**  
**Classe B**

BS EN 16165  
ANNEX C  
>36 wet  
slider 96

DCOF>  
0,42 Wet

6 mm 1/4" ↑↓



**GRES FINE PORCELLANATO**  
FINE PORCELAIN STONEWARE / GRÈS CÉRAMÉ FIN / FEINSTEINZEUG-KOLLEKTIONEN / GRES PORCELÁNICO FINO  
SQUADRATO - SQUARED - EQUARRI - REKTIFIZIERT - ESCUADRADO

9 mm 3/8" ↑↓		COLOR	SURFACE	60x120 23 <sup>5/8"</sup> x47 <sup>1/4"</sup>	60x60 23 <sup>5/8"</sup> x23 <sup>5/8"</sup>	30x60 11 <sup>4/5"</sup> x23 <sup>5/8"</sup>	
<b>PLIMATECH</b>		PLIMAGRAY/03	NATURALE/MATTE	776576 ■ FL-09100	776515 ■ FL-05800	776504 ■ FL-05800	
			STRUTTURATO	776666 ■ FL-09100	-	-	
6 mm 1/4" ↑↓		COLOR	SURFACE	120x280 47 <sup>1/4"</sup> x110 <sup>1/4"</sup>	120x240 47 <sup>1/4"</sup> x94 <sup>1/2"</sup>	120x120 47 <sup>1/4"</sup> x47 <sup>1/4"</sup>	60x120 23 <sup>5/8"</sup> x47 <sup>1/4"</sup>
<b>PLIMATECH</b>		PLIMAGRAY/03	NATURALE/MATTE	776419 ■ FL-10800	776557 ■ FL-09900	776568 ■ FL-08400	776585 ■ FL-07700

## PLIMAWHITE/01

4 grafiche continue / 4 continuous pattern graphics



**Es. posa:**

Il disegno riprodotto è indicativo. Come per il materiale naturale la grafica può mostrare discontinuità di vena nel passaggio da una lastra all'altra. Per questo motivo differenze fino a 1,5 cm devono essere considerate come caratteristica del prodotto; non è garantita la sequenza delle facce in fase di approntamento dell'ordine.

**Example of installation:**

The drawing is indicative. As with natural material, graphics may show vein discontinuities in the transition from one slab to another. For this reason, differences of up to 1.5 cm must be considered as a product characteristic. The sequence of the faces is not guaranteed when placing the order.

6 mm 1/4" 	COLOR	SURFACE	<b>160x320</b> 63"x126"
PLIMATECH 	PLIMAWHITE/01	MATTE	777636 ■ FL-14300

Le grafiche sopra riportate si riferiscono al formato 160x320 / The above designs refer to size 160x320 cm / Les graphismes indiqués ci-dessus se réfèrent au format 160x320  
Die oben abgebildeten Grafiken beziehen sich auf das Format 160x320 / Las gráficas arriba indicadas se refieren a la medida 160x320.













## GRES FINE PORCELLANATO

FINE PORCELAIN STONEWARE / GRÈS CÉRAMÉ FIN / FEINSTEINZEUG-KOLLEKTIONEN / GRES PORCELÁNICO FINO  
SQUADRATO - SQUARED - EQUARRI - REKTIFIZIERT - ESCUADRADO

9 mm 3/8" ↑↓		COLOR	SURFACE	30x60 11 4/5" x 23 5/8"  muretto 3D A+B pz/box 4
		PLIMAWHITE/02	NATURALE/MATTE	776729 ▲ FL-06710
<b>PLIMATECH</b>		PLIMABEIGE/02	NATURALE/MATTE	776730 ▲ FL-06710
		PLIMAGRAY/02	NATURALE/MATTE	776731 ▲ FL-06710

## PEZZI SPECIALI/SPECIAL TRIMS/PIÈCES SPÉCIALES/FORMSTÜCKE/PIEZAS ESPECIALES

9 mm 3/8" ↑↓		COLOR	SURFACE	4,6x60 1 4/5" x 23 5/8"  battiscopa	33x120x3 13" x 47 1/4" x 1 1/8"  gradino pz/box 2
		PLIMAWHITE/01	NATURALE/MATTE	776676 ◆ FL-01600	776685 ▲ FL-20400
		PLIMAWHITE/02	NATURALE/MATTE	776679 ◆ FL-01600	776688 ▲ FL-20400
		PLIMAWHITE/03	NATURALE/MATTE	776682 ◆ FL-01600	776691 ▲ FL-20400
		PLIMABEIGE/01	NATURALE/MATTE	776677 ◆ FL-01600	776686 ▲ FL-20400
<b>PLIMATECH</b>		PLIMABEIGE/02	NATURALE/MATTE	776680 ◆ FL-01600	776689 ▲ FL-20400
		PLIMABEIGE/03	NATURALE/MATTE	776683 ◆ FL-01600	776692 ▲ FL-20400
		PLIMAGRAY/01	NATURALE/MATTE	776678 ◆ FL-01600	776687 ▲ FL-20400
		PLIMAGRAY/02	NATURALE/MATTE	776681 ◆ FL-01600	776690 ▲ FL-20400
		PLIMAGRAY/03	NATURALE/MATTE	776684 ◆ FL-01600	776693 ▲ FL-20400



**Per un effetto ottimale della posa, Florim suggerisce di mantenere 2 mm di fuga per pose monoformato e 3 mm per combinare formati misti** - For optimal installation results, Florim recommends maintaining a joint of 2 mm 1/16" for single format installations and 3 mm 1/8" to combine mixed formats. - Pour réaliser une pose parfait, Florim conseille de laisser 2 mm de joint pour la pose des monoformats et 3 mm pour les combinaisons de formats mixtes. - Um einen optimalen effekt beim verlegen zu erzielen empfiehlt Florim eine 2 mm fugе bei einformatigen verlegungen und 3 mm fugе bei formatkombinationen - Para lograr los máximos resultados en la posa del producto, Florim aconseja 2 mm de junta en aplicaciones monoformato y 3 mm en combinaciones de formatos mixtos



**In relazione alle differenti tecnologie produttive l'accostamento di prodotti con spessori diversi potrebbe presentare delle disomogeneità, se ne sconsiglia pertanto l'abbinamento.** / Due to the different production technologies, contiguous installation of products with different thickness may give a non-homogeneous result. For this reason we do not recommend this option. / Vu que différentes technologies de production sont utilisées avec des épaisseurs différentes, des problèmes d'homogénéité pourraient se présenter, il est donc déconseillé de les poser ensemble. / Wegen unterschiedlicher Produktionstechnologien können die Fliesen mit verschiedenen Materialstärken optische Differenzen aufweisen. Von einem direkten Aneinanderlegen wird deshalb abgeraten. / Dadas las diferentes tecnologías productivas, la combinación de productos de diferentes espesores podría dar lugar a heterogeneidad, por lo que se desaconseja mezclarlas.











# PLIMATECH

## GRES FINE PORCELLANATO

FINE PORCELAIN STONEWARE / GRÈS CÉRAMÉ FIN / FEINSTEINZEUG-KOLLEKTIONEN / GRES PORCELÁNICO FINO  
SQUADRATO - SQUARED - EQUARRI - REKTIFIZIERT - ESCUADRADO

6 mm 1/4" ↑↓	COLOR	SURFACE	30x60 11 4/5" x 23 5/8"	30x34 11 4/5" x 13 2/5"
			muretto pz/box 6	HIVE pz/box 10
	PLIMAWHITE/02	NATURALE/MATTE	776704 ▲ FL-03400	776709 ▲ FL-03790
<b>PLIMATECH</b>				
	PLIMABEIGE/02	NATURALE/MATTE	776705 ▲ FL-03400	776710 ▲ FL-03790
	PLIMAGRAY/02	NATURALE/MATTE	776706 ▲ FL-03400	776711 ▲ FL-03790

## PEZZI SPECIALI/SPECIAL TRIMS/PIÈCES SPÉCIALES/FORMSTÜCKE/PIEZAS ESPECIALES

6 mm 1/4" ↑↓	COLOR	SURFACE	4,6x60 1 4/5" x 23 5/8"
			battiscopa
	PLIMAWHITE/01	NATURALE/MATTE	776695 ◆ FL-01800
	PLIMAWHITE/02	NATURALE/MATTE	776698 ◆ FL-01800
	PLIMAWHITE/03	NATURALE/MATTE	776701 ◆ FL-01800
	PLIMABEIGE/01	NATURALE/MATTE	776696 ◆ FL-01800
<b>PLIMATECH</b>			
	PLIMABEIGE/02	NATURALE/MATTE	776699 ◆ FL-01800
	PLIMABEIGE/03	NATURALE/MATTE	776702 ◆ FL-01800
	PLIMAGRAY/01	NATURALE MATTE	776697 ◆ FL-01800
	PLIMAGRAY/02	NATURALE MATTE	776700 ◆ FL-01800
	PLIMAGRAY/03	NATURALE MATTE	776703 ◆ FL-01800

FLORM OVERSIZE  
**magnUm**

**160x320/120x280/120x240/120x120/60x120**

Specifica Imballo pag.  
Packaging specifications on page  
Spécifications d'emballage à page  
Verpackungsdetail Seite  
Especificaciones de embalaje a la página  
**194/195**

PLIMATECH	scatola - box			pallet		
	pz	mq	kg	box	mq	kg
60x120	2	1,44	27,73	30	43,20	860
60x60	3	1,08	21,49	40	43,20	890
30x60	6	1,08	21,49	40	43,20	890

PLIMATECH	scatola - box			pallet		
	pz	ml	kg	box	mq	kg
4,6x60 battiscopa	14	8,40	8,40	-	-	-



# PLIMATECH OUTDOOR

## Vantaggi tecnici - Technical advantages - Avantages techniques Technische Vorteile - Ventajas técnicas

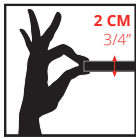

- Lastra monolitica compatta di spessore 2 cm squadrata e rettificata
- Compact monolithic slab 2 cm thick squared and rectified
- Dalle monolithique compacte de 2 cm d'épaisseur, équarrie et rectifiée
- Kompakte monolithische Platte, 2 cm dick, rechteckig und scharfkantig geschliffen
- Losa monolítica compacta de 2 cm de espesor, escuadrada y rectificada.



- INGELIVO
- FROST RESISTANT
- INGÉLIF
- FROSTBESTÄNDIG
- RESISTENTE A LA HELADA



- ELEVATA RESISTENZA AI CARICHI STATICI
- HIGH STATIC LOAD RESISTANCE
- RÉSISTANCE ÉLEVÉE AUX CHARGES STATIQUES
- HOHE STATISCHE BELASTBARKEIT
- ELEVADA RESISTENCIA A LAS CARGAS ESTÁTICAS

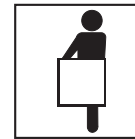

- FACILE DA POSARE
- EASY TO INSTALL
- FACILE À POSER
- VERLEGELEICHT
- FÁCIL DE COLOCAR



- ANTISCIVOLO R11
- ANTI SLIP R11
- ANTIDÉRAPANT R11
- RUTSCHFEST R11
- ANTIDESLIZANTE R11

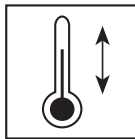

- RESISTENTE AGLI SBALZI TERMICI
- THERMAL SHOCK RESISTANT
- RÉSISTANT AUX ÉCARTS THERMIQUES
- TEMPERATURWECHSELBESTÄNDIG
- RESISTENTE A LAS OSCILACIONES TÉRMICAS



- FACILE DA PULIRE
- EASY TO CLEAN
- FACILE À NETTOYER
- REINIGUNGSLEICHT
- FÁCIL DE LIMPIAR

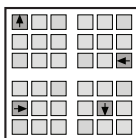

- RIMOVIBILE E RIUTILIZZABILE
- REMOVABLE AND REUSABLE
- DÉMONTABLE ET RÉUTILISABLE
- ENTFERNBAR UND WIEDERVERWENDBAR
- DESMONTABLE Y REUTILIZABLE



- INATTACCABILE DA AGENTI CHIMICI E MUFFE
- IMPERVIOUS TO ATTACK BY CHEMICALS OR MOULD
- RÉSISTANT AUX AGENTS CHIMIQUES ET AUX MOISSISSURES
- UNANGREIFBAR DURCH CHEMISCHE STOFFE UND SCHIMMEL
- RESISTENTE A LOS AGENTES QUÍMICOS Y A LOS MOHOS

## Applicazioni - Applications - Applications - Verlegung - Aplicaciones

- Posa diretta su erba
- Direct installation on grass
- Pose directe sur de l'herbe
- Verlegung direkt auf Rasen
- Colocación directa sobre hierba

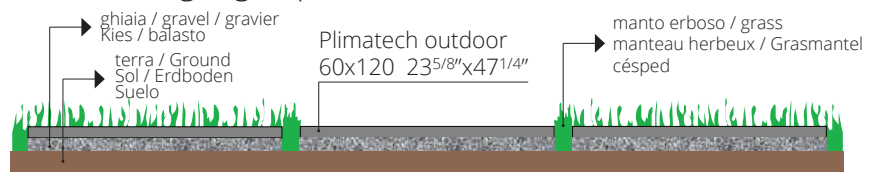

- Posa diretta su ghiaia
- Direct installation over gravel
- Pose direct sur du gravier
- Verlegung direkt auf Kies
- Colocación directa sobre grava



- Posa su massetto cementizio
- Installation on sand-cement screed
- Pose sur chape ciment
- Verlegung auf Zement-Unterbetonblock
- Colocación sobre contrapiso de hormigón

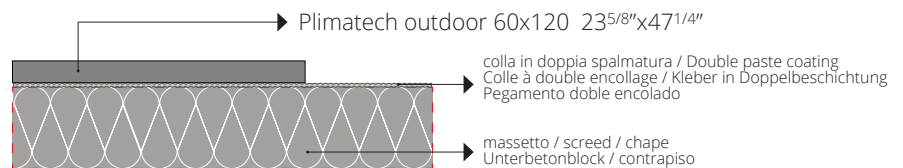

- Posa su piedini fissi o regolabili
- Installation on fixed or adjustable feet
- Pose sur pieds fixes ou réglables
- Verlegung auf feststehende oder regulierbare Füße
- Colocación sobre pies fijos o regulables

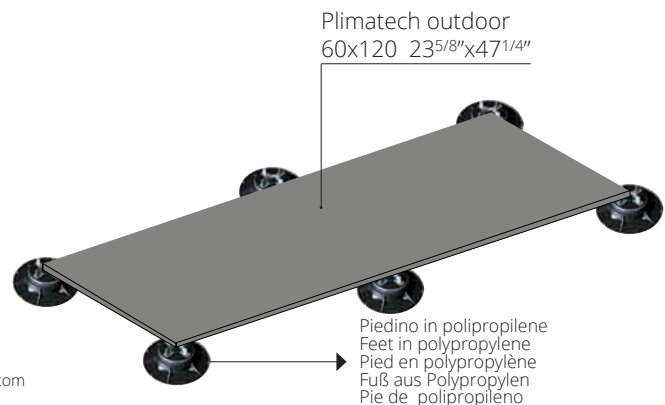

Per le specifiche di utilizzo dei sistemi sopraelevati vedi il sito florim.com  
For the specifics on use of raised systems visit the site florim.com  
Pour les caractéristiques d'utilisation des systèmes surélevés, voir le site florim.com  
Für die Nutzungsbedingungen der Doppelbodensysteme siehe Webseite florim.com  
Para las especificaciones de empleo de los sistemas sobreelevados consulte el sitio web florim.com

Le lastre ceramiche sono sottoposte a un trattamento di compattazione termica che assicura resistenza e durata nel tempo. Il bassissimo assorbimento d'acqua rende perciò il materiale ingelivo. Ciò può comportare ristagni d'acqua superficiali anche per materiale installato a regola d'arte. / Ceramic tiles undergo a compacting thermal treatment that ensures resistance and durability. The low level of water absorption makes the slabs frost resistant. This could result in superficial water stagnations even if materials are installed in a workmanlike manner. / Les carreaux de céramique subissent un traitement thermique de compactage qui assure résistance et durabilité. Le faible niveau d'absorption d'eau rend les dalles résistantes au gel. Il pourrait en résulter des stagnations d'eau superficielles, même si les dalles ont été installées dans les règles de l'art. / Die Keramikplatten werden einer thermischen Verdichtung unterzogen, welche die Widerstandsfähigkeit und Langlebigkeit sichert. Die extrem niedrige Wasseraufnahme macht das Material frostsicher. Die hohe Materialdichte kann, auch bei einer perfekten Verlegung, eine längere Abtrochnungszeit von angestaumtem Wasser zur Folge haben. / Las baldosas cerámicas se someten a un tratamiento de compactación térmica que asegura resistencia y durabilidad. La baja absorción de agua hace que las baldosas resistan al hielo. Esto podría resultar en estancamientos superficiales de agua, incluso si los materiales están instalados según las reglas del arte.



## PLIMAWHITE/02



## PLIMABEIGE/02



**R11  
CLASSE C**

DCOF >  
0,42 Wet

20 mm 3/4" ↑↓



## PLIMAGRAY/02



### GRES FINE PORCELLANATO

FINE PORCELAIN STONEWARE/GRES CERAME FIN/FEINSTEINZEUG-KOLLEKTIONEN/GRES PORCELANICO FINO  
SQUADRATO - SQUARED - EQUARRI - REKTIFIZIERT - ESCUADRADO

20 mm 3/4" ↑↓

	COLOR	SURFACE	60x120 23 <sup>5/8</sup> "x47 <sup>1/4</sup> "
	PLIMAWHITE/02	STRUTTURATO	776401 ■ FL-11300
	PLIMABEIGE/02	STRUTTURATO	776404 ■ FL-11300
	PLIMAGRAY/02	STRUTTURATO	776407 ■ FL-11300

### PLIMATECH



ISO 10545-4	RESISTENZA ALLA FLESSIONE IN N/mm <sup>2</sup> N/mm <sup>2</sup> FLEXURAL STRENGTH TEST / RESISTANCE A LA FLEXION EN N/mm <sup>2</sup> / BIEGEFESTIGKEIT IN N/mm <sup>2</sup> / RESISTENCIA A LA FLEXION EN N/mm <sup>2</sup>	valore medio 52 N/mm <sup>2</sup>
	Forza di rottura in N (sp. > 7,5 mm) Breaking strength in N (sp. > 7,5 mm) / Fuerza de ruptura en N (sp. > 7,5 mm) / Bruchlast in N (Dicke > 7,5 mm) / Fuerza de rotura en N (gr. > 7,5 mm)	valore medio 14000 N

PLIMATECH	scatola - box			pallet		
	pz	mq	kg	box	mq	kg
60x120 20mm	1	0,72	32,26	30	21,60	1000





# RAWTECH

gres fine porcellanato  
fine porcelain stoneware  
grès cérame fin  
feinsteinzeug-kollektionen  
gres porcelánico fino







## RAWTECH

Un cemento vissuto, usurato dal tempo in cui l'imperfezione diventa il segno distintivo. **Rawtech** è il frutto di un atteggiamento progettuale che vuole recuperare il carattere identitario di un prodotto marcatamente industriale per riportarlo con gusto contemporaneo alle esigenze dell'abitare più sofisticato. Un cemento vissuto, usurato dal tempo in cui l'imperfezione diventa il segno distintivo e requisito fondamentale per esprimere al meglio uno stile inconfondibile.

**Rawtech** is the result of a design approach which aims to recapture the true identity of an essentially industrial product and at the same time appeal to the sophisticated demands of contemporary living styles. A tile with experience, worn by time, where imperfection becomes a hallmark, a prerequisite to better express its truly unmistakable style.

**Rawtech** est le fruit d'une réflexion en matière de conception qui vise à se réappropriier le caractère identitaire d'un produit résolument industriel pour le rapprocher, dans un style contemporain, des exigences d'un habitat plus sophistiqué. Un ciment ancien, usé par le passage du temps, où l'imperfection est un signe distinctif et un prérequis fondamental pour exprimer au mieux un style unique.

**Rawtech** ist das Ergebnis eines Designerstils, der die Identitätseigenschaften eines ausgesprochen industriellen Produkts zurückgewinnen und sie an die Bedürfnisse eines zeitgenössischen, anspruchsvolleren Wohnens anpassen möchte. Eine gelebte, mit der Zeit abgenutzte Fliese mit Betoneffekt, auf der die Unvollkommenheit zum Kennzeichen und damit zur Grundvoraussetzung eines unvergleichlichen Stils wird.

**Rawtech** es fruto de un planteamiento proyectual que desea recuperar el carácter identificador de un producto fuertemente industrial para satisfacer con gusto contemporáneo las necesidades de la vivienda más sofisticada. Un cemento para disfrutar, gastado por el tiempo, en el que la imperfección se convierte en signo distintivo y requisito fundamental para expresar lo mejor posible un estilo inconfundible.



## RAW-WHITE



## RAW-MUD



**R10**  
**Classe B**  
(naturale)

**R11**  
**Classe A+B**  
(strutturato)

DCOF>  
0,42 Wet

**9 mm** 3/8" ↑↓



**R9**  
**Classe A**

DCOF>  
0,42 Wet

**6 mm** 1/4" ↑↓

FLORIM OVERSIZE  
**magnum**

### GRES FINE PORCELLANATO

FINE PORCELAIN STONEWARE / GRÈS CÉRAME FIN / FEINSTEINZEUG-KOLLEKTIONEN / GRES PORCELÁNICO FINO

SQUADRATO - SQUARED - EQUARRI - REKTIFIZIERT - ESCUADRADO

<b>9 mm</b> 3/8" ↑↓		COLOR	SURFACE	<b>80x180</b> 31 1/2" x 70 5/8"	<b>60x120</b> 23 5/8" x 47 1/4"	<b>80x80</b> 31 1/2" x 31 1/2"	<b>40x80</b> 15 3/4" x 31 1/2"	<b>60x60</b> 23 5/8" x 23 5/8"	<b>30x60</b> 11 4/8" x 23 5/8"
<b>RAWTECH</b>		RAW-WHITE	NATURALE	752184 ■ FL-10500	752196 ■ FL-08100	752188 ■ FL-08100	752192 ■ FL-05800	752200 ■ FL-05300	752204 ■ FL-04600
			STRUTTURATO	-	-	-	-	753922 ■ FL-05300	752208 ■ FL-04600
		RAW-MUD	NATURALE	752186 ■ FL-10500	752198 ■ FL-08100	752190 ■ FL-08100	752194 ■ FL-05800	752202 ■ FL-05300	752206 ■ FL-04600
			STRUTTURATO	-	-	-	-	753923 ■ FL-05300	752210 ■ FL-04600
<b>6 mm</b> 1/4" ↑↓		COLOR	SURFACE	<b>120x240</b> 47 1/4" x 94 1/2"	<b>120x120</b> 47 1/4" x 47 1/4"	<b>60x120</b> 23 5/8" x 47 1/4"			
<b>RAWTECH</b>		RAW-WHITE	NATURALE	757825 ■ FL-09900	757821 ■ FL-08400	757817 ■ FL-07700			

## RAW-DUST



## RAW-COAL



**R10**  
**Classe B**  
(naturale)

**R11**  
**Classe A+B**  
(strutturato)

DCOF >  
0,42 Wet

9 mm 3/8" ↑↓



**R9**  
**Classe A**

DCOF >  
0,42 Wet

6 mm 1/4" ↑↓

FLOHM OVERSIZE  
**magnuM**

**GRES FINE PORCELLANATO**  
FINE PORCELAIN STONEWARE / GRÈS CÉRAME FIN / FEINSTEINZEUG-KOLLEKTIONEN / GRES PORCELÁNICO FINO  
SQUADRATO - SQUARED - EQUARRI - REKTIFIZIERT - ESCUADRADO

9 mm 3/8" ↑↓		COLOR	SURFACE	80x180 31 1/2" x 70 5/8"	60x120 23 5/8" x 47 1/4"	80x80 31 1/2" x 31 1/2"	40x80 15 3/4" x 31 1/2"	60x60 23 5/8" x 23 5/8"	30x60 11 4/5" x 23 5/8"
<b>RAWTECH</b>	RAW-DUST	NATURALE		752187 ■ FL-10500	752199 ■ FL-08100	752191 ■ FL-08100	752195 ■ FL-05800	752203 ■ FL-05300	752207 ■ FL-04600
		STRUTTURATO		-	-	-	-	753924 ■ FL-05300	752211 ■ FL-04600
	RAW-COAL	NATURALE		752185 ■ FL-10500	752197 ■ FL-08100	752189 ■ FL-08100	752193 ■ FL-05800	752201 ■ FL-05300	752205 ■ FL-04600
		STRUTTURATO		-	-	-	-	753925 ■ FL-05300	752209 ■ FL-04600
6 mm 1/4" ↑↓		COLOR	SURFACE	120x240 47 1/4" x 94 1/2"	120x120 47 1/4" x 47 1/4"	60x120 23 5/8" x 47 1/4"			
<b>RAWTECH</b>	RAW-DUST	NATURALE		757826 ■ FL-09900	757822 ■ FL-08400	757818 ■ FL-07700			

# RAWTECH

9 mm 3/8" ↑↓	COLOR	SURFACE	30x30 11 4/5" x 11 4/5"	21x40 8 1/4" x 15 3/4"
			mosaico tessere 3x3 pz/box 11	modulo listello sfalsato pz/box 5
RAWTECH	RAW-WHITE	NATURALE	753904 ▲ FL-01600	752212 ▲ FL-01600
	RAW-MUD	NATURALE	753905 ▲ FL-01600	752214 ▲ FL-01600
	RAW-DUST	NATURALE	753906 ▲ FL-01600	752215 ▲ FL-01600
	RAW-COAL	NATURALE	753907 ▲ FL-01600	752213 ▲ FL-01600

## PEZZI SPECIALI/SPECIAL TRIMS/PIÈCES SPÉCIALES/FORMSTÜCKE/PIEZAS ESPECIALES

9 mm 3/8" ↑↓	COLOR	SURFACE	4,6x60 1 4/5" x 23 5/8"	33x120x3 13" x 47 1/4" x 1 1/8"	33x120x3 13" x 47 1/4" x 1 1/8"	33x120x3 13" x 47 1/4" x 1 1/8"	33x120x3 13" x 47 1/4" x 1 1/8"
			battiscopa	gradino pz/box 2	angolo gradino dx pz/box 2	angolo gradino sx pz/box 2	angolo gradino dx/sx pz/box 1
RAWTECH	RAW-WHITE	NATURALE	752216 ◆ FL-01600	753908 ▲ FL-20400	753912 ▲ FL-31100	753916 ▲ FL-31100	754092 ▲ FL-42900
	RAW-MUD	NATURALE	752218 ◆ FL-01600	753909 ▲ FL-20400	753913 ▲ FL-31100	753917 ▲ FL-31100	754093 ▲ FL-42900
	RAW-DUST	NATURALE	752219 ◆ FL-01600	753910 ▲ FL-20400	753914 ▲ FL-31100	753918 ▲ FL-31100	754094 ▲ FL-42900
	RAW-COAL	NATURALE	752217 ◆ FL-01600	753911 ▲ FL-20400	753915 ▲ FL-31100	753919 ▲ FL-31100	754095 ▲ FL-42900



Recycled material content certification

FLORM OVERSIZE  
**magnum**

**120x240/120x120/60x120**  
 Specifica Imballo pag.  
 Packaging specifications on page  
 Spécifications d'emballage à page  
 Verpackungsdetail Seite  
 Especificaciones de embalaje a la página  
**194/195**

RAWTECH	scatola - box			pallet		
	pz	mq	kg	box	mq	kg
80x180	2	2,88	57,60	20	57,60	1210
60x120	2	1,44	28,08	30	43,20	870
80x80	2	1,28	24,96	40	51,20	1030
60x60	3	1,08	21,06	40	43,20	870
40x80	3	0,96	18,53	56	53,76	1070
30x60	6	1,08	20,84	40	43,20	860

RAWTECH	scatola - box			pallet		
	pz	ml	kg	box	mq	kg
4,6x60 battiscopa	14	8,40	8,40	-	-	-

**Per un effetto ottimale della posa, Florim suggerisce di mantenere 2 mm di fuga per pose monoformato e 3 mm per combinare formati misti** - For optimal installation results, Florim recommends maintaining a joint of 2 mm 1/12" for single format installations and 3 mm 1/8" to combine mixed formats. - Pour réaliser une pose parfaite, Florim conseille de laisser 2 mm de joint pour la pose des monoformats et 3 mm pour les combinaisons de formats mixtes. - Um einen optimalen effekt beim verlegen zu erzielen empfiehlt Florim eine 2 mm fugе bei einformatigen verlegungen und 3 mm fugе bei formatkombinationen Para lograr los máximos resultados en la posa del producto, Florim aconseja 2 mm de junta en aplicaciones monoformato y 3 mm en combinaciones de formatos mixtos.

**In relazione alle differenti tecnologie produttive l'accostamento di prodotti con spessori diversi potrebbe presentare delle disomogeneità, se ne sconsiglia pertanto l'abbinamento.** / Due to the different production technologies, contiguous installation of products with different thickness may give a non-homogeneous result. For this reason we do not recommend this option. / Vu que différentes technologies de production sont utilisées avec des épaisseurs différentes, des problèmes d'homogénéité pourraient se présenter, il est donc déconseillé de les poser ensemble. / Wegen unterschiedlicher Produktionstechnologien können die Fliesen mit verschiedenen Materialstärken optische Differenzen aufweisen. Von einem direkten Aneinanderlegen wird deshalb abgeraten. / Dadas las diferentes tecnologías productivas, la combinación de productos de diferentes espesores podría dar lugar a heterogeneidad, por lo que se desaconseja mezclarlas.







# RAWTECH OUTDOOR

## Vantaggi tecnici - Technical advantages - Avantages techniques Technische Vorteile - Ventajas técnicas

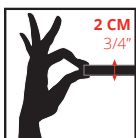

- Lastra monolitica compatta di spessore 2 cm squadrata e rettificata
- Compact monolithic slab 2 cm thick squared and rectified
- Dalle monolithique compacte de 2 cm d'épaisseur, équarrie et rectifiée
- Kompakte monolithische Platte, 2 cm dick, rechteckig und scharfkantig geschliffen
- Losa monolítica compacta de 2 cm de espesor, escuadrada y rectificada.

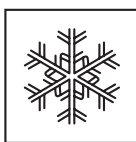

- INGELIVO
- FROST RESISTANT
- INGÉLIF
- FROSTBESTÄNDIG
- RESISTENTE A LA HELADA



- ELEVATA RESISTENZA AI CARICHI STATICI
- HIGH STATIC LOAD RESISTANCE
- RÉSISTANCE ÉLEVÉE AUX CHARGES STATIQUES
- HOHE STATISCHE BELASTBARKEIT
- ELEVADA RESISTENCIA A LAS CARGAS ESTÁTICAS



- FACILE DA POSARE
- EASY TO INSTALL
- FACILE À POSER
- VERLEGELEICHT
- FÁCIL DE COLOCAR



- ANTISCIVOLO R11
- ANTI SLIP R11
- ANTIDÉRAPANT R11
- RUTSCHFEST R11
- ANTIDESLIZANTE R11

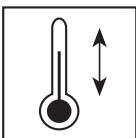

- RESISTENTE AGLI SBALZI TERMICI
- THERMAL SHOCK RESISTANT
- RÉSISTANT AUX ÉCARTS THERMIQUES
- TEMPERATURWECHSELBESTÄNDIG
- RESISTENTE A LAS OSCILACIONES TÉRMICAS



- FACILE DA PULIRE
- EASY TO CLEAN
- FACILE À NETTOYER
- REINIGUNGSLEICHT
- FÁCIL DE LIMPIAR

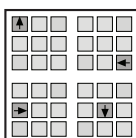

- RIMOVIBILE E RIUTILIZZABILE
- REMOVABLE AND REUSABLE
- DÉMONTABLE ET RÉUTILISABLE
- ENTFERNBAR UND WIEDERVERWENDBAR
- DESMONTABLE Y REUTILIZABLE



- INATTACCABILE DA AGENTI CHIMICI E MUFFE
- IMPERVIOUS TO ATTACK BY CHEMICALS OR MOULD
- RÉSISTANT AUX AGENTS CHIMIQUES ET AUX MOISSISSURES
- UNANGREIFBAR DURCH CHEMISCHE STOFFE UND SCHIMMEL
- RESISTENTE A LOS AGENTES QUÍMICOS Y A LOS MOHOS

## Applicazioni - Applications - Applications - Verlegung - Aplicaciones

- Posa diretta su erba
- Direct installation on grass
- Pose directe sur de l'herbe
- Verlegung direkt auf Rasen
- Colocación directa sobre hierba



- Posa diretta su ghiaia
- Direct installation over gravel
- Pose direct sur du gravier
- Verlegung direkt auf Kies
- Colocación directa sobre grava



- Posa su massetto cementizio
- Installation on sand-cement screed
- Pose sur chape ciment
- Verlegung auf Zement-Unterbetonblock
- Colocación sobre contrapiso de hormigón

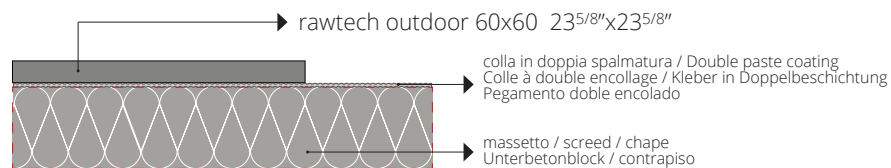

- Posa su piedini fissi o regolabili
- Installation on fixed or adjustable feet
- Pose sur pieds fixes ou réglables
- Verlegung auf feststehende oder regulierbare Füße
- Colocación sobre pies fijos o regulables

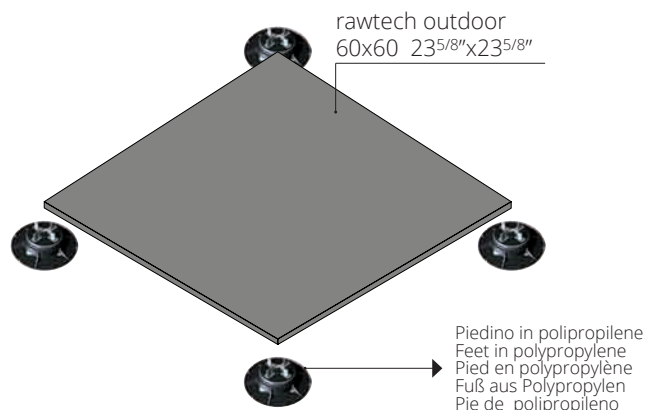

Per le specifiche di utilizzo dei sistemi sopraelevati vedi il sito florim.com  
For the specifics on use of raised systems visit the site florim.com  
Pour les caractéristiques d'utilisation des systèmes surélevés, voir le site florim.com  
Für die Nutzungsbedingungen der Doppelbodensysteme siehe Webseite florim.com  
Para las especificaciones de empleo de los sistemas sobreelevados consulte el sitio web florim.com

Le lastre ceramiche sono sottoposte a un trattamento di compattazione termica che assicura resistenza e durata nel tempo. Il bassissimo assorbimento d'acqua rende perciò il materiale ingelivo. Ciò può comportare ristagni d'acqua superficiali anche per materiale installato a regola d'arte. / Ceramic tiles undergo a compacting thermal treatment that ensures resistance and durability. The low level of water absorption makes the slabs frost resistant. This could result in superficial water stagnations even if materials are installed in a workmanlike manner. / Les carreaux de céramique subissent un traitement thermique de compactage qui assure résistance et durabilité. Le faible niveau d'absorption d'eau rend les dalles résistantes au gel. Il pourrait en résulter des stagnations d'eau superficielles, même si les dalles ont été installées dans les règles de l'art. / Die Keramikplatten werden einer thermischen Verdichtung unterzogen, welche die Widerstandsfähigkeit und Langlebigkeit sichert. Die extrem niedrige Wasseraufnahme macht das Material frostsicher. Die hohe Materialdichte kann, auch bei einer perfekten Verlegung, eine längere Abtrocknungszeit von angestaumtem Wasser zur Folge haben. / Las baldosas cerámicas se someten a un tratamiento de compactación térmica que asegura resistencia y durabilidad. La baja absorción de agua hace que las baldosas resistan al hielo. Esto podría resultar en estancamientos superficiales de agua, incluso si los materiales están instalados según las reglas del arte.

## RAW-WHITE



## RAW-MUD



**R11**  
**CLASSE**  
**A+B**

DCOF >  
0,42 Wet

20 mm 3/4" ↑↓

## RAW-DUST



## RAW-COAL



### GRES FINE PORCELLANATO

FINE PORCELAIN STONEWARE/GRES CERAME FIN/FEINSTEINZEUG-KOLLEKTIONEN/GRES PORCELANICO FINO  
SQUADRATO - SQUARED - EQUARRI - REKTIFIZIERT - ESCUADRADO

20 mm 3/4" ↑↓

	COLOR	SURFACE	60x120 23 <sup>5</sup> / <sub>8</sub> "x47 <sup>1</sup> / <sub>4</sub> "	60x60 23 <sup>5</sup> / <sub>8</sub> "x23 <sup>5</sup> / <sub>8</sub> "
<b>RAWTECH</b>	RAW-WHITE	STRUTTURATO	762773 ■ FL-11300	762732 ■ FL-09300
	RAW-MUD	STRUTTURATO	-	762734 ■ FL-09300
	RAW-DUST	STRUTTURATO	762774 ■ FL-11300	762735 ■ FL-09300
	RAW-COAL	STRUTTURATO	-	762733 ■ FL-09300

Product Certification  
**BUREAU VERITAS**  
Certification



Recycled material content certification

### PEZZI SPECIALI

Special trims/Pièces spéciales/Formstücke  
Piezas especiales  
pag 184/187

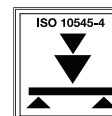

**RESISTENZA ALLA FLESSIONE IN N/mm<sup>2</sup>**  
N/mm<sup>2</sup> FLEXURAL STRENGTH TEST / RESISTANCE  
A LA FLEXION EN N/mm<sup>2</sup> / BIEGEFESTIGKEIT IN  
N/mm<sup>2</sup> / RESISTENCIA A LA FLEXION EN N/mm<sup>2</sup>

**Forza di rottura in N (sp. > 7,5 mm)**  
Breaking strength in N (thickness > 7,5 mm) / Forza de  
ruptura en N (esp. > 7,5 mm) / Bruchlast in N (Dicke >  
7,5 mm) / Fuerza de rotura en N (gr. > 7,5 mm)

valore medio  
52 N/mm<sup>2</sup>

valore medio  
14000 N

RAWTECH	scatola - box			pallet		
	pz	mq	kg	box	mq	kg
60x120 20mm	1	0,72	32,04	30	21,60	990
60x60 20mm	2	0,72	32,15	30	21,60	990



# STONTECH/4.0

gres fine porcellanato  
fine porcelain stoneware  
grès cérame fin  
feinsteinzeug-kollektionen  
gres porcelánico fino







## STONTECH/4.0

Progettare è un processo permanente di riflessione in cui seguire un percorso logico pur lasciando spazio alle emozioni, per questo Florim ha deciso di riprogettare la serie **Stontech** che da tempo accompagna il suo modo di interpretare l'abitare. Nuove superfici, nuovi formati e 3 differenti finiture compongono un racconto contemporaneo attento al dettaglio secondo la filosofia del marchio. Due marmi in finitura high-glossy regalano alla serie frammenti di luce preziosa e i grandi formati della famiglia Magnum oversize, in quattro colori, permettono di comporre soluzioni volumetriche inusuali dal forte valore architettuale.

Designing projects is an ongoing process of reflection in which a logical path is followed, while leaving room for the emotions. That's why Florim has decided to redesign the **Stontech** range, which has long been a part of its way of interpreting living spaces. New surfaces, new sizes and 3 different finishes tell a contemporary tale with careful attention paid to the detail, in accordance with the brand philosophy. Two high-gloss finish marbles give the range rays of precious light and the large sizes belonging to the Magnum Oversize family, in four colours, enable solutions to be created with unusual volumes and a considerable architectural content.

Concevoir est un processus de réflexion permanent vers un parcours logique qui laisse libre cours aux émotions, raison pour laquelle Florim a décidé de revisiter la série **Stontech** qui accompagne depuis longtemps sa façon d'interpréter le concept d'habitat. De nouvelles surfaces, de nouveaux formats et trois finitions différentes qui composent un récit moderne et attentif aux détails comme le veut la philosophie de la marque. Deux marbres à la finition ultra brillante embellissent la série de fragments de lumière raffinée tandis que les grands formats de la famille Magnum oversize, disponibles en quatre coloris, permettent de composer des solutions volumétriques inusuelles à forte valeur architecturale.

Die Planungsphase ist ein permanenter Reflexionsprozess, bei dem man einen logischen Weg geht und gleichzeitig dazu Raum für Emotionen lässt. Deshalb hat Florim beschlossen, die Serie **Stontech** neu zu gestalten, die seit geraumer Zeit ihre Interpretationslösungen für den Wohnbereich begleitet. Neue Oberflächen, neue Formate und 3 verschiedene Finishes bilden eine zeitgemäße Kollektion, bei der ganz nach der Philosophie der Marke die Liebe zum Detail im Vordergrund steht. Zwei hochglänzende Marmorsteine verleihen der Serie wertvolle Lichtfragmente. Die vier Farben der Großformate der Produktfamilie Magnum Oversize schaffen ungewöhnliche volumetrische Lösungen von hohem architektonischem Wert.

Diseñar es un proceso permanente de reflexión en el que hay que seguir una trayectoria lógica dejando espacio a las emociones y, precisamente por eso, Florim ha decidido volver a diseñar la serie **Stontech** que desde hace tiempo acompaña su forma de interpretar la vivienda. Nuevas superficies, nuevos formatos y 3 acabados distintos componen una historia contemporánea atenta al detalle según la filosofía de la marca. Dos mármoles con un acabado high-glossy aportan a la serie fragmentos de una luz preciosa y los grandes formatos de la familia Magnum oversize, en cuatro colores, permiten componer soluciones volumétricas inusuales con un fuerte valor arquitectónico.

# STONTECH/4.0

## STONE\_01



## STONE\_02



### GRES FINE PORCELLANATO

FINE PORCELAIN STONEWARE / GRÈS CÉRAME FIN / FEINSTEINZEUG-KOLLEKTIONEN / GRES PORCELÁNICO FINO  
SQUADRATO - SQUARED - EQUARRI - REKTIFIZIERT - ESCUADRADO

9 mm 3/8" ↑↓

	COLOR	SURFACE	60x120 23 <sup>5/8"</sup> x47 <sup>1/4"</sup>	80x80 31 <sup>1/2"</sup> x31 <sup>1/2"</sup>	60x60 23 <sup>5/8"</sup> x23 <sup>5/8"</sup>	30x60 11 <sup>4/5"</sup> x23 <sup>5/8"</sup>
STONE_01	NATURALE		761172 ■ FL-09100	761184 ■ FL-08100	761166 ■ FL-05800	761160 ■ FL-04900
	HIGH-GLOSSY		761206 ■ FL-10500	761210 ■ FL-09700	761204 ■ FL-07300	761202 ■ FL-06500
	STRUTTURATO		761212 ■ FL-09100	-	-	-
	CANNETÈ		761218 ■ FL-09100	-	-	-
STONE_01		R+PTV	761190 ■ FL-09100	-	761196 ■ FL-05800	761263 ■ FL-04900
STONE_02	NATURALE		761173 ■ FL-09100	761185 ■ FL-08100	761167 ■ FL-05800	761161 ■ FL-04900
	STRUTTURATO		761213 ■ FL-09100	-	-	-
	CANNETÈ		761219 ■ FL-09100	-	-	-
	R+PTV		761191 ■ FL-09100	-	761197 ■ FL-05800	761264 ■ FL-04900

6 mm 1/4" ↑↓

	COLOR	SURFACE	120x280 47 <sup>1/4"</sup> x110 <sup>1/4"</sup>	120x240 47 <sup>1/4"</sup> x94 <sup>1/2"</sup>	120x120 47 <sup>1/4"</sup> x47 <sup>1/4"</sup>	60x120 23 <sup>5/8"</sup> x47 <sup>1/4"</sup>
STONE_01	NATURALE		761502 ■ FL-10800	761508 ■ FL-09900	761514 ■ FL-08400	761520 ■ FL-07700
	HIGH-GLOSSY		761500 ■ FL-13400	761506 ■ FL-12400	761512 ■ FL-10800	761518 ■ FL-10300
STONE_02	NATURALE		761503 ■ FL-10800	761509 ■ FL-09900	761515 ■ FL-08400	761521 ■ FL-07700
	R+PTV		-	762817 ■ FL-09900	762813 ■ FL-08400	-



V2

R9  
(naturale/  
cannetè)

R10  
Classe B  
(R+PTV)

R11  
Classe C  
(strutturato)

DCOF>  
0,42 Wet  
(naturale/  
R+PTV/  
strutturato/  
cannetè)

BS EN 16165  
ANNEX C  
>36 wet  
slider 96  
R+PTV

9 mm 3/8" ↑↓



V2

R9  
(naturale)

R10  
Classe B  
(R+PTV)

DCOF>  
0,42 Wet

BS EN 16165  
ANNEX C  
>36 wet  
slider 96  
R+PTV

6 mm 1/4" ↑↓

FLORIM OVERSIZE  
magnum

## STONE\_03

## STONE\_04

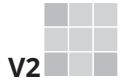

V2

**R9**  
(naturale/  
cannetè)

**R10**  
**Classe B**  
(R+PTV)

**R11**  
**Classe C**  
(strutturato)

DCOF>  
0,42 Wet  
(naturale/  
R+PTV/  
strutturato/  
cannetè)



BS EN 16165  
ANNEX C  
>36 wet  
slider 96  
R+PTV

9 mm 3/8" ↑↓

### GRES FINE PORCELLANATO

FINE PORCELAIN STONEWARE / GRÈS CÉRAME FIN / FEINSTEINZEUG-KOLLEKTIONEN / GRES PORCELÁNICO FINO  
SQUADRATO - SQUARED - EQUARRI - REKTIFIZIERT - ESCUADRADO

9 mm 3/8" ↑↓

		COLOR	SURFACE	60x120 23 <sup>5</sup> / <sub>8</sub> "x47 <sup>1</sup> / <sub>4</sub> "	80x80 31 <sup>1</sup> / <sub>2</sub> "x31 <sup>1</sup> / <sub>2</sub> "	60x60 23 <sup>5</sup> / <sub>8</sub> "x23 <sup>5</sup> / <sub>8</sub> "	30x60 11 <sup>4</sup> / <sub>5</sub> "x23 <sup>5</sup> / <sub>8</sub> "
<b>STONTECH/4.0</b>	STONE_03		NATURALE	761174 ■ FL-09100	761186 ■ FL-08100	761168 ■ FL-05800	761162 ■ FL-04900
			STRUTTURATO	761214 ■ FL-09100	-	-	-
			CANNETÈ	761220 ■ FL-09100	-	-	-
			R+PTV	761192 ■ FL-09100	-	761198 ■ FL-05800	761265 ■ FL-04900
	STONE_04		NATURALE	761175 ■ FL-09100	761187 ■ FL-08100	761169 ■ FL-05800	761163 ■ FL-04900
			STRUTTURATO	761215 ■ FL-09100	-	-	-
			CANNETÈ	761221 ■ FL-09100	-	-	-
R+PTV			761193 ■ FL-09100	-	761199 ■ FL-05800	761266 ■ FL-04900	



# STONTECH/4.0

## STONE\_05



## STONE\_06

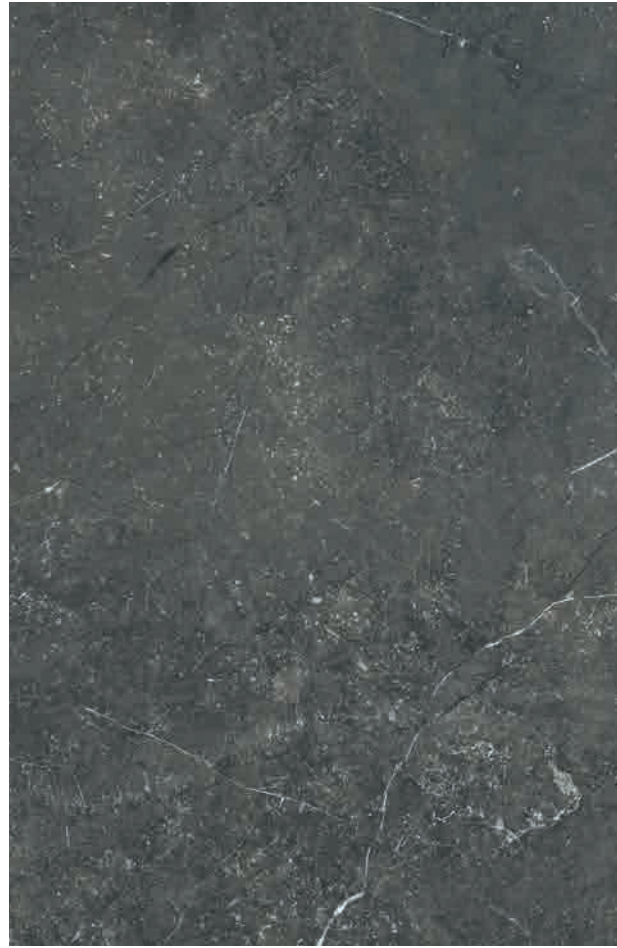

**R9**  
(naturale/  
cannetè)

**R10**  
**Classe B**  
(R+PTV)

**R11**  
**Classe C**  
(strutturato)

DCOF>  
0,42 Wet  
(naturale/  
R+PTV/  
strutturato/  
cannetè)

BS EN 16165  
ANNEX C  
>36 wet  
slider 96  
R+PTV









9 mm 3/8" ↓

### GRES FINE PORCELLANATO











FINE PORCELAIN STONEWARE / GRÈS CÉRAME FIN / FEINSTEINZEUG-KOLLEKTIONEN / GRES PORCELÁNICO FINO  
SQUADRATO - SQUARED - EQUARRI - REKTIFIZIERT - ESCUADRADO

9 mm 3/8" ↓

		COLOR	SURFACE	60x120 23 <sup>5</sup> / <sub>8</sub> "x47 <sup>1</sup> / <sub>4</sub> "	80x80 31 <sup>1</sup> / <sub>2</sub> "x31 <sup>1</sup> / <sub>2</sub> "	60x60 23 <sup>5</sup> / <sub>8</sub> "x23 <sup>5</sup> / <sub>8</sub> "	30x60 11 <sup>4</sup> / <sub>5</sub> "x23 <sup>5</sup> / <sub>8</sub> "
	STONE_05	NATURALE	NATURALE	761176 ■ FL-09100	761188 ■ FL-08100	761170 ■ FL-05800	761164 ■ FL-04900
			HIGH-GLOSSY	761207 ■ FL-10500	761211 ■ FL-09700	761205 ■ FL-07300	761203 ■ FL-06500
			STRUTTURATO	761216 ■ FL-09100	-	-	-
			CANNETÈ	761222 ■ FL-09100	-	-	-
<b>STONTECH/4.0</b>	STONE_05	R+PTV	R+PTV	761194 ■ FL-09100	-	761200 ■ FL-05800	761267 ■ FL-04900
			NATURALE	761177 ■ FL-09100	761189 ■ FL-08100	761171 ■ FL-05800	761165 ■ FL-04900
			STRUTTURATO	761217 ■ FL-09100	-	-	-
			CANNETÈ	761223 ■ FL-09100	-	-	-
	STONE_06	R+PTV	R+PTV	761195 ■ FL-09100	-	761201 ■ FL-05800	761268 ■ FL-04900

9 mm 3/8" ↑↓				<b>30x30</b> 1 1/4" x 1 1/4"	<b>21x40</b> 8 1/4" x 1 5/8"
	COLOR	SURFACE	 mosaico tessere 3x3 pz/box 11	 modulo listello sfalsato	
<b>STONTECH/4.0</b>		NATURALE	761487 ▲ FL-02000	761477 ■ FL-17200	
		HIGH-GLOSSY	761484 ▲ FL-02300	761475 ■ FL-21000	
		NATURALE	761488 ▲ FL-02000	761478 ■ FL-17200	
		NATURALE	761489 ▲ FL-02000	761480 ■ FL-17200	
		NATURALE	761491 ▲ FL-02000	761481 ■ FL-17200	
		NATURALE	761492 ▲ FL-02000	761482 ■ FL-17200	
		HIGH-GLOSSY	761486 ▲ FL-02300	761476 ■ FL-21000	
		NATURALE	761493 ▲ FL-02000	761483 ■ FL-17200	

PEZZI SPECIALI/SPECIAL TRIMS/PIÈCES SPÉCIALES/FORMSTÜCKE/PIEZAS ESPECIALES

9 mm 3/8" ↑↓				<b>4,6x60</b> 1 4/5" x 23 5/8"	<b>33x120x3</b> 13" x 47 1/4" x 1 1/8"	<b>33x120x3</b> 13" x 47 1/4" x 1 1/8"	<b>33x120x3</b> 13" x 47 1/4" x 1 1/8"
	COLOR	SURFACE	 battiscopa	 gradino pz/box 2	 angolo gradino dx pz/box 2	 angolo gradino sx pz/box 2	
<b>STONTECH/4.0</b>		NATURALE	761451 ◆ FL-01600	761457 ▲ FL-20400	761463 ▲ FL-31100	761469 ▲ FL-31100	
		HIGH-GLOSSY	761449 ◆ FL-01600	-	-	-	
		NATURALE	761452 ◆ FL-01600	761458 ▲ FL-20400	761464 ▲ FL-31100	761470 ▲ FL-31100	
		NATURALE	761453 ◆ FL-01600	761459 ▲ FL-20400	761465 ▲ FL-31100	761471 ▲ FL-31100	
		NATURALE	761454 ◆ FL-01600	761460 ▲ FL-20400	761466 ▲ FL-31100	761472 ▲ FL-31100	
		NATURALE	761455 ◆ FL-01600	761461 ▲ FL-20400	761467 ▲ FL-31100	761473 ▲ FL-31100	
		HIGH-GLOSSY	761450 ◆ FL-01600	-	-	-	
		NATURALE	761456 ◆ FL-01600	761462 ▲ FL-20400	761468 ▲ FL-31100	761474 ▲ FL-31100	

# STONTECH/4.0

PEZZI SPECIALI/SPECIAL TRIMS/PIÈCES SPÉCIALES/FORMSTÜCKE/PIEZAS ESPECIALES

6 mm 1/4"		COLOR	SURFACE	30x30 11 4/5"x11 4/5" mosaico tessere 7,5x7,5 pz/box 11	30x30 11 4/5"x11 4/5" muretto tessere 7,5x15 pz/box 11	30x30 11 4/5"x11 4/5" mosaico tessere 1,5x3 pz/box 11	4,6x80 1 4/5"x3 1/2" battiscopa
STONTECH/4.0		STONE_01	NATURALE	761439 ▲ FL-01800	761445 ▲ FL-01800	761433 ▲ FL-02700	761427 ◆ FL-01800
			HIGH-GLOSSY	761437 ▲ FL-02100	761443 ▲ FL-02100	761431 ▲ FL-03100	761425 ◆ FL-01800
		STONE_02	NATURALE	761440 ▲ FL-01800	761446 ▲ FL-01800	761434 ▲ FL-02700	761428 ◆ FL-01800



FLORM OVERSIZE  
**magnUm**

**160x320/120x240/120x120/60x120**  
 Specifica Imballo pag.  
 Packaging specifications on page  
 Spécifications d'emballage à page  
 Verpackungsdetail Seite  
 Especificaciones de embalaje a la página  
**194/195**

STONTECH/4.0	scatola - box			pallet		
	pz	mq	kg	box	mq	kg
60x120	2	1,44	28,08	30	43,20	870
80x80	2	1,28	24,96	40	51,20	1030
60x60	3	1,08	21,06	40	43,20	870
30x60	6	1,08	20,84	40	43,20	860
21x40 modulo listello sfalsato	5	0,42	9,66	40	16,80	420

**Per un effetto ottimale della posa, Florim suggerisce di mantenere 2 mm di fuga per pose monoformato e 3 mm per combinare formati misti** - For optimal installation results, Florim recommends maintaining a joint of 2 mm 1/12" for single format installations and 3 mm 1/8" to combine mixed formats. - Pour réaliser une pose parfait, Florim conseille de laisser 2 mm de joint pour la pose des monoformats et 3 mm pour les combinaisons de formats mixtes. - Um einen optimalen effekt beim verlegen zu erzielen empfiehlt Florim eine 2 mm fugе bei einformatigen verlegungen und 3 mm fugе bei formatkombinationen Para lograr los máximos resultados en la posa del producto, Florim aconseja 2 mm de junta en aplicaciones monoformato y 3 mm en combinaciones de formatos mixtos.

STONTECH/4.0	scatola - box			pallet		
	pz	ml	kg	box	mq	kg
4,6x60 battiscopa	14	8,40	8,40	-	-	-

**In relazione alle differenti tecnologie produttive l'accostamento di prodotti con spessori diversi potrebbe presentare delle disomogeneità, se ne sconsiglia pertanto l'abbinamento.** / Due to the different production technologies, contiguous installation of products with different thickness may give a non-homogeneous result. For this reason we do not recommend this option. / Vu que différentes technologies de production sont utilisées avec des épaisseurs différentes, des problèmes d'homogénéité pourraient se présenter, il est donc déconseillé de les poser ensemble. / Wegen unterschiedlicher Produktionstechnologien können die Fliesen mit verschiedenen Materialstärken optische Differenzen aufweisen. Von einem direkten Aneinanderlegen wird deshalb abgeraten. / Dadas las diferentes tecnologías productivas, la combinación de productos de diferentes espesores podría dar lugar a heterogeneidad, por lo que se desaconseja mezclarlas.

## STONE\_01

4 grafiche continue / 4 continuous pattern graphics

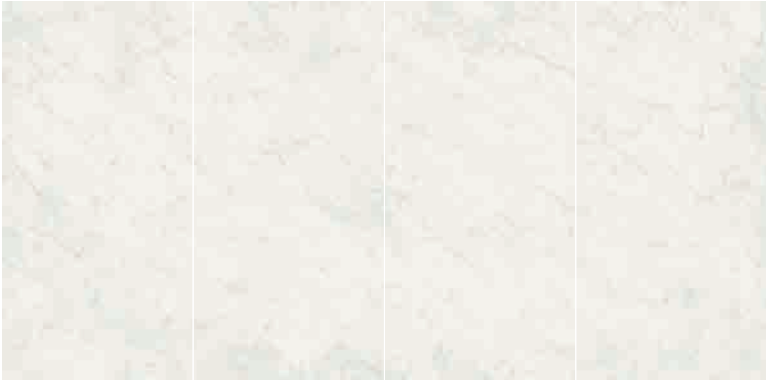

### Es. posa:

Il disegno riprodotto è indicativo. Come per il materiale naturale la grafica può mostrare discontinuità di vena nel passaggio da una lastra all'altra. Per questo motivo differenze fino a 1,5 cm devono essere considerate come caratteristica del prodotto; non è garantita la sequenza delle facce in fase di approntamento dell'ordine.

### Example of installation:

The drawing is indicative. As with natural material, graphics may show vein discontinuities in the transition from one slab to another. For this reason, differences of up to 1.5 cm must be considered as a product characteristic. The sequence of the faces is not guaranteed when placing the order.

6 mm 1/4" ↓	COLOR	SURFACE	160x320 63"x126"
-------------	-------	---------	---------------------

STONTECH/4.0	STONE_01	MATTE	777637 ■ FL-14300
--------------	----------	-------	----------------------

Le grafiche sopra riportate si riferiscono al formato 160x320 / The above designs refer to size 160x320 cm / Les graphismes indiqués ci-dessus se réfèrent au format 160x320  
Die oben abgebildeten Grafiken beziehen sich auf das Format 160x320 / Las gráficas arriba indicadas se refieren a la medida 160x320.



# STONTECH/4.0 OUTDOOR

## Vantaggi tecnici - Technical advantages - Avantages techniques Technische Vorteile - Ventajas técnicas

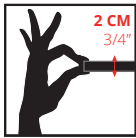

- Lastra monolitica compatta di spessore 2 cm squadrata e rettificata
- Compact monolithic slab 2 cm thick squared and rectified
- Dalle monolithique compacte de 2 cm d'épaisseur, équarrie et rectifiée
- Kompakte monolithische Platte, 2 cm dick, rechteckig und scharfkantig geschliffen
- Losa monolítica compacta de 2 cm de espesor, escuadrada y rectificada.



- INGELIVO
- FROST RESISTANT
- INGÉLIF
- FROSTBESTÄNDIG
- RESISTENTE A LA HELADA



- ELEVATA RESISTENZA AI CARICHI STATICI
- HIGH STATIC LOAD RESISTANCE
- RÉSISTANCE ÉLEVÉE AUX CHARGES STATIQUES
- HOHE STATISCHE BELASTBARKEIT
- ELEVADA RESISTENCIA A LAS CARGAS ESTÁTICAS



- FACILE DA POSARE
- EASY TO INSTALL
- FACILE À POSER
- VERLEGELEICHT
- FÁCIL DE COLOCAR



- ANTISCIVOLO R11
- ANTI SLIP R11
- ANTIDÉRAPANT R11
- RUTSCHFEST R11
- ANTIDESLIZANTE R11

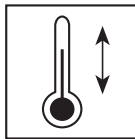

- RESISTENTE AGLI SBALZI TERMICI
- THERMAL SHOCK RESISTANT
- RÉSISTANT AUX ÉCARTS THERMIQUES
- TEMPERATURWECHSELBESTÄNDIG
- RESISTENTE A LAS OSCILACIONES TÉRMICAS



- FACILE DA PULIRE
- EASY TO CLEAN
- FACILE À NETTOYER
- REINIGUNGSLEICHT
- FÁCIL DE LIMPIAR

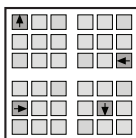

- RIMOVIBILE E RIUTILIZZABILE
- REMOVABLE AND REUSABLE
- DÉMONTABLE ET RÉUTILISABLE
- ENTFERNBAR UND WIEDERVERWENDBAR
- DESMONTABLE Y REUTILIZABLE



- INATTACCABILE DA AGENTI CHIMICI E MUFFE
- IMPERVIOUS TO ATTACK BY CHEMICALS OR MOULD
- RÉSISTANT AUX AGENTS CHIMIQUES ET AUX MOISSISSURES
- UNANGREIFBAR DURCH CHEMISCHE STOFFE UND SCHIMMEL
- RESISTENTE A LOS AGENTES QUÍMICOS Y A LOS MOHOS

## Applicazioni - Applications - Applications - Verlegung - Aplicaciones

- Posa diretta su erba
- Direct installation on grass
- Pose directe sur de l'herbe
- Verlegung direkt auf Rasen
- Colocación directa sobre hierba



- Posa diretta su ghiaia
- Direct installation over gravel
- Pose direct sur du gravier
- Verlegung direkt auf Kies
- Colocación directa sobre grava



- Posa su massetto cementizio
- Installation on sand-cement screed
- Pose sur chape ciment
- Verlegung auf Zement-Unterbetonblock
- Colocación sobre contrapiso de hormigón

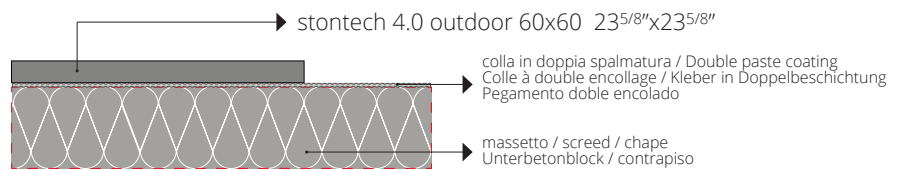

- Posa su piedini fissi o regolabili
- Installation on fixed or adjustable feet
- Pose sur pieds fixes ou réglables
- Verlegung auf feststehende oder regulierbare Füße
- Colocación sobre pies fijos o regulables

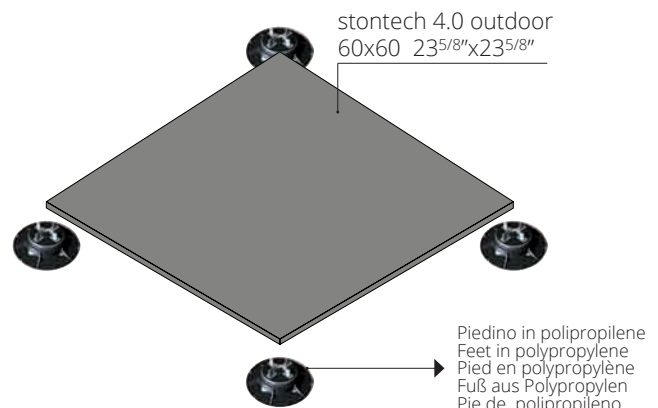

Per le specifiche di utilizzo dei sistemi sopraelevati vedi il sito florim.com  
For the specifics on use of raised systems visit the site florim.com  
Pour les caractéristiques d'utilisation des systèmes surélevés, voir le site florim.com  
Für die Nutzungsbedingungen der Doppelbodensysteme siehe Webseite florim.com  
Para las especificaciones de empleo de los sistemas sobreelevados consulte el sitio web florim.com

Le lastre ceramiche sono sottoposte a un trattamento di compattazione termica che assicura resistenza e durata nel tempo. Il bassissimo assorbimento d'acqua rende perciò il materiale ingelivo. Ciò può comportare ristagni d'acqua superficiali anche per materiale installato a regola d'arte. / Ceramic tiles undergo a compacting thermal treatment that ensures resistance and durability. The low level of water absorption makes the slabs frost resistant. This could result in superficial water stagnations even if materials are installed in a workmanlike manner. / Les carreaux de céramique subissent un traitement thermique de compactage qui assure résistance et durabilité. Le faible niveau d'absorption d'eau rend les dalles résistantes au gel. Il pourrait en résulter des stagnations d'eau superficielles, même si les dalles ont été installées dans les règles de l'art. / Die Keramikplatten werden einer thermischen Verdichtung unterzogen, welche die Widerstandsfähigkeit und Langlebigkeit sichert. Die extrem niedrige Wasseraufnahme macht das Material frostsicher. Die hohe Materialdichte kann, auch bei einer perfekten Verlegung, eine längere Abtrochnungszeit von angestaumtem Wasser zur Folge haben. / Las baldosas cerámicas se someten a un tratamiento de compactación térmica que asegura resistencia y durabilidad. La baja absorción de agua hace que las baldosas resistan al hielo. Esto podría resultar en estancamientos superficiales de agua, incluso si los materiales están instalados según las reglas del arte.

## STONE\_01



## STONE\_02



R11  
CLASSE C

20 mm 3/4" ↑↓

## STONE\_03



## STONE\_04

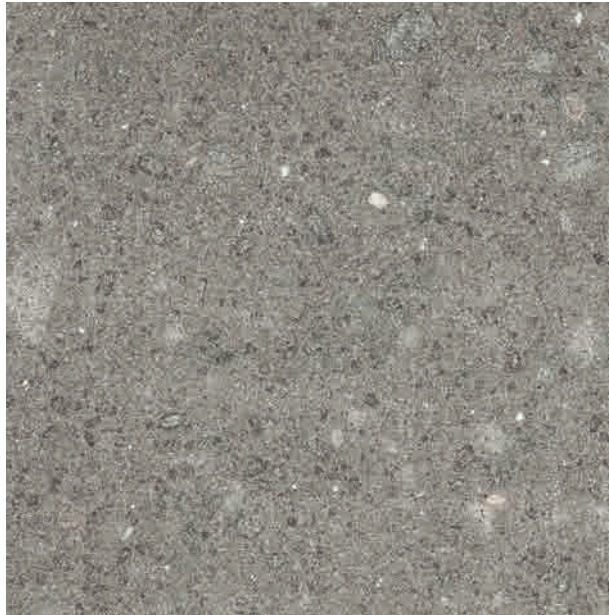

### GRES FINE PORCELLANATO

FINE PORCELAIN STONEWARE/GRES CERAME FIN/FEINSTEINZEUG-KOLLEKTIONEN/GRES PORCELANICO FINO  
SQUADRATO - SQUARED - EQUARRI - REKTIFIZIERT - ESCUADRADO

20 mm 3/4" ↑↓

COLOR	SURFACE	60x120 23 <sup>5/8"</sup> x47 <sup>1/4"</sup>
-------	---------	--

	STONE_01	STRUTTURATO	762788 ■ FL-11300
--	----------	-------------	----------------------

	STONE_02	STRUTTURATO	762789 ■ FL-11300
--	----------	-------------	----------------------

### STONTECH/4.0

	STONE_03	STRUTTURATO	762790 ■ FL-11300
--	----------	-------------	----------------------

	STONE_04	STRUTTURATO	762791 ■ FL-11300
--	----------	-------------	----------------------

### PEZZI SPECIALI

Special trims/Pièces spéciales/Formstücke  
Piezas especiales  
pag 184/187



Recycled material content certification

20mm  
STONE\_03 / STONE\_04

ISO 10545-4	RESISTENZA ALLA FLESSIONE IN N/mm <sup>2</sup> N/mm <sup>2</sup> FLEXURAL STRENGTH TEST / RESISTANCE A LA FLEXION EN N/mm <sup>2</sup> / BIEGEFESTIGKEIT IN N/mm <sup>2</sup> / RESISTENCIA A LA FLEXION EN N/mm <sup>2</sup>	valore medio 52 N/mm <sup>2</sup>
	Forza di rottura in N (sp. > 7,5 mm) Breaking strength in N (thicknes > 7,5 mm) / Force de rupture en N (ép. > 7,5 mm) / Bruchlast in N (Dicke > 7,5 mm) / Fuerza de rotura en N (es. > 7,5 mm)	valore medio 14000 N

STONTECH/4.0	scatola - box			pallet		
	pz	mq	kg	box	mq	kg
60x120 20mm	1	0,72	32,26	30	21,60	1000





## WALKS/1.0

gres fine porcellanato  
fine porcelain stoneware  
grès cérame fin  
feinsteinzeug-kollektionen  
gres porcelánico fino







## WALKS/1.0

**Walks 1.0** è tecnologia e natura, unite in modo esatto e incisivo. Precisione estetica, rigore e pulizia formale contraddistinguono le scelte cromatiche che caratterizzano la serie accentuando la sua semplicità non convenzionale. Disponibile in due finiture, soft e naturale, è perfetta per interpretare architetture di interni e spazi esterni che dialogano con il paesaggio circostante. Un design dal linguaggio internazionale, accattivante e senza tempo.

**Walks 1.0** is technology and nature, precisely and incisively joint. Aesthetical precision, rigour and formal cleaning distinguish the colour choices that characterise the series, accentuating its unconventional simplicity. Available in two finishes, soft and natural, it is perfect for interpreting indoor architecture and outdoor spaces that converse with the surrounding setting. A design with international language, catchy and timeless.

**Walks 1.0** est la technologie et la nature qui s'unissent parfaitement de manière incisive. Précision esthétique, rigueur et netteté formelle distinguent les choix des teintes qui caractérisent la série en accentuant sa simplicité non conventionnelle. Disponible en deux finitions, soft et naturelle, elle s'adapte parfaitement à l'interprétation d'architectures d'intérieurs et d'espaces extérieurs qui dialoguent avec le paysage qui les entoure. Un design avec un langage International, captivant et intemporel.

**Walks 1.0** ist auf exakte und einprägsame Art mit Natur vereinte Technologie. Ästhetische Präzision, Strenge und Reinheit der Formen zeichnen die Farbwahl der Serie aus und betonen deren unkonventionelle Einfachheit. Sie ist in den zwei Endbearbeitungen, Soft und Natürlich, erhältlich und eignet sich perfekt dazu, Innenarchitekturen und Außenflächen in Harmonie mit der umliegenden Landschaft zu interpretieren. Ein Design mit internationalem, ansprechendem und zeitlosen Flair.

**Walks 1.0** es tecnología y naturaleza, unidas en un modo exacto e incisivo. Precisión estética, rigor y limpieza formal contradistinguen las elecciones cromáticas que caracterizan la serie, acentuando su sencillez no convencional. Disponible en dos acabados, soft y natural, es perfecta para interpretar arquitecturas de interiores y exteriores, que dialogan con el paisaje alrededor. Un diseño con un lenguaje internacional, cautivador y sin tiempo.

# WALKS/1.0

## WHITE



## GRAY

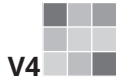

V4



**R11**  
Classe C  
(naturale)

**R9**  
(soft)

DCOF>  
0,42 Wet

9 mm 3/8" ↑↓

**GRES FINE PORCELLANATO**  
FINE PORCELAIN STONEWARE / GRÈS CÉRAME FIN / FEINSTEINZEUG-KOLLEKTIONEN / GRES PORCELÁNICO FINO  
SQUADRATO - SQUARED - EQUARRI - REKTIFIZIERT - ESCUADRADO

9 mm 3/8" ↑↓		COLOR	SURFACE	60x120 23 <sup>5/8"</sup> x47 <sup>1/4"</sup>	40x80 15 <sup>3/4"</sup> x31 <sup>1/2"</sup>	60x60 23 <sup>5/8"</sup> x23 <sup>5/8"</sup>	30x60 11 <sup>4/5"</sup> x23 <sup>5/8"</sup>
<b>WALKS/1.0</b>		WHITE	NATURALE	742827 ■ FL-09300	728722 ■ FL-06700	728746 ■ FL-06700	728755 ■ FL-05800
			SOFT	742831 ■ FL-09300	728726 ■ FL-06700	728750 ■ FL-06700	728759 ■ FL-05800
		GRAY	NATURALE	742828 ■ FL-09300	728723 ■ FL-06700	728747 ■ FL-06700	728756 ■ FL-05800
			SOFT	742832 ■ FL-09300	728727 ■ FL-06700	728752 ■ FL-06700	728760 ■ FL-05800



## BEIGE



## BLACK



V4

**R11**  
Classe C  
(naturale)



**R9**  
(soft)

DCOF>  
0,42 Wet

9 mm 3/8" ↑↓





### GRES FINE PORCELLANATO

FINE PORCELAIN STONEWARE / GRÈS CÉRAME FIN / FEINSTEINZEUG-KOLLEKTIONEN / GRES PORCELÁNICO FINO  
SQUADRATO - SQUARED - EQUARRI - REKTIFIZIERT - ESCUADRADO





9 mm 3/8" ↑↓		COLOR	SURFACE	60x120 23 <sup>5/8"</sup> x47 <sup>1/4"</sup>	40x80 15 <sup>3/4"</sup> x31 <sup>1/2"</sup>	60x60 23 <sup>5/8"</sup> x23 <sup>5/8"</sup>	30x60 11 <sup>4/5"</sup> x23 <sup>5/8"</sup>
<b>WALKS/1.0</b>		BEIGE	NATURALE	742829 ■ FL-09300	728724 ■ FL-06700	728748 ■ FL-06700	728757 ■ FL-05800
			SOFT	742833 ■ FL-09300	728728 ■ FL-06700	728753 ■ FL-06700	728761 ■ FL-05800
		BLACK	NATURALE	742830 ■ FL-09300	728725 ■ FL-06700	728749 ■ FL-06700	728758 ■ FL-05800
			SOFT	742834 ■ FL-09300	728729 ■ FL-06700	728754 ■ FL-06700	728762 ■ FL-05800



# WALKS/1.0

9 mm 3/8" ↑↓		COLOR	SURFACE	30x30 11 4/5" x 11 4/5"	21x40 8 1/4" x 15 3/4"
				mosaico tessere 3x3	modulo listello sfalsato
WALKS/1.0		WHITE	NATURALE	728797 ■ FL-14000	728780 ■ FL-17200
			SOFT	-	729495 ■ FL-17200
		GRAY	NATURALE	728799 ■ FL-14000	728782 ■ FL-17200
			SOFT	-	729498 ■ FL-17200
		BEIGE	NATURALE	728798 ■ FL-14000	728781 ■ FL-17200
			SOFT	-	729496 ■ FL-17200
		BLACK	NATURALE	728800 ■ FL-14000	728783 ■ FL-17200
			SOFT	-	729500 ■ FL-17200

## PEZZI SPECIALI/SPECIAL TRIMS/PIÈCES SPÉCIALES/FORMSTÜCKE/PIEZAS ESPECIALES

9 mm 3/8" ↑↓		COLOR	SURFACE	4,6x60 1 4/5" x 23 5/8"	33x60x3 13" x 23 5/8" x 1 1/8"	33x33x3 13" x 13" x 1 1/8"	20x30x6 7 7/8" x 11 4/5" x 2 1/8"	1x20 2/5" x 7 7/8"	1x21 2/5" x 8 1/4"
				battiscopa	gradino pz/box 4	angolo gradino pz/box 2	elemento elle pz/box 6	quarter round pz/box 12	angolo quarter round pz/box 4
WALKS/1.0		WHITE	NATURALE	-	728784 ▲ FL-09300	728788 ▲ FL-10500	728801 ▲ FL-01700	728831 ▲ FL-01160	728835 ▲ FL-01700
			SOFT	745559 ◆ FL-01600	-	-	-	-	
		GRAY	NATURALE	-	728786 ▲ FL-09300	728791 ▲ FL-10500	728805 ▲ FL-01700	728833 ▲ FL-01160	728837 ▲ FL-01700
			SOFT	745561 ◆ FL-01600	-	-	-	-	
		BEIGE	NATURALE	-	728785 ▲ FL-09300	728790 ▲ FL-10500	728804 ▲ FL-01700	728832 ▲ FL-01160	728836 ▲ FL-01700
			SOFT	745560 ◆ FL-01600	-	-	-	-	
		BLACK	NATURALE	-	728787 ▲ FL-09300	728792 ▲ FL-10500	728806 ▲ FL-01700	728834 ▲ FL-01160	728838 ▲ FL-01700
			SOFT	745562 ◆ FL-01600	-	-	-	-	

WALKS/1.0	scatola - box			pallet		
	pz	mq	kg	box	mq	kg
60x120	2	1,44	30,20	30	43,20	930
40x80	3	0,96	22,00	56	53,76	1260
60x60	3	1,08	24,20	40	43,20	990
30x60	6	1,08	24,20	40	43,20	990
21x40 mod. list. sfalsato	5	0,42	8,40	40	16,80	360
30x30 mosaico	11	1,00	20,00	30	30,00	630

WALKS/1.0	scatola - box			pallet		
	pz	ml	kg	box	mq	kg
4,6x60 battiscopa	14	8,40	8,40	-	-	-

**Per un effetto ottimale della posa, Florim suggerisce di mantenere 2 mm di fuga per pose monoformato e 3 mm per combinare formati misti.** - For optimal installation results, Florim recommends maintaining a joint of 2 mm 1/12" for single format installations and 3 mm 1/8" to combine mixed formats. - Pour réaliser une pose parfaite, Florim conseille de laisser 2 mm de joint pour la pose des monoformats et 3 mm pour les combinaisons de formats mixtes. - Um einen optimalen effekt beim verlegen zu erzielen empfiehlt Florim eine 2 mm fugе bei einformatigen verlegungen und 3 mm fugе bei formatkombinationen Para lograr los máximos resultados en la posa del producto, Florim aconseja 2 mm de junta en aplicaciones monoformato y 3 mm en combinaciones de formatos mixtos.



# WALKS/1.0 OUTDOOR

## Vantaggi tecnici - Technical advantages - Avantages techniques Technische Vorteile - Ventajas técnicas

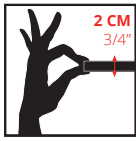

- Lastra monolitica compatta di spessore 2 cm squadrata e rettificata
- Compact monolithic slab 2 cm thick squared and rectified
- Dalle monolithique compacte de 2 cm d'épaisseur, équerrie et rectifiée
- Kompakte monolithische Platte, 2 cm dick, rechteckig und scharfkantig geschliffen
- Losa monolítica compacta de 2 cm de espesor, escuadrada y rectificada.



- INGELIVO
- FROST RESISTANT
- INGÉLIF
- FROSTBESTÄNDIG
- RESISTENTE A LA HELADA



- ELEVATA RESISTENZA AI CARICHI STATICI
- HIGH STATIC LOAD RESISTANCE
- RÉSISTANCE ÉLEVÉE AUX CHARGES STATIQUES
- HOHE STATISCHE BELASTBARKEIT
- ELEVADA RESISTENCIA A LAS CARGAS ESTÁTICAS



- FACILE DA POSARE
- EASY TO INSTALL
- FACILE À POSER
- VERLEGELEICHT
- FÁCIL DE COLOCAR



- ANTISCIVOLO R11
- ANTI SLIP R11
- ANTIDÉRAPANT R11
- RUTSCHFEST R11
- ANTIDESLIZANTE R11

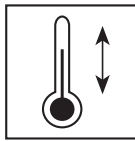

- RESISTENTE AGLI SBALZI TERMICI
- THERMAL SHOCK RESISTANT
- RÉSISTANT AUX ÉCARTS THERMIQUES
- TEMPERATURWECHSELBESTÄNDIG
- RESISTENTE A LAS OSCILACIONES TÉRMICAS



- FACILE DA PULIRE
- EASY TO CLEAN
- FACILE À NETTOYER
- REINIGUNGSLEICHT
- FÁCIL DE LIMPIAR

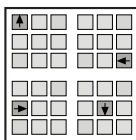

- RIMOVIBILE E RIUTILIZZABILE
- REMOVABLE AND REUSABLE
- DÉMONTABLE ET RÉUTILISABLE
- ENTFERNBAR UND WIEDERVERWENDBAR
- DESMONTABLE Y REUTILIZABLE



- INATTACCABILE DA AGENTI CHIMICI E MUFFE
- IMPERVIOUS TO ATTACK BY CHEMICALS OR MOULD
- RÉSISTANT AUX AGENTS CHIMIQUES ET AUX MOISSISSURES
- UNANGREIFBAR DURCH CHEMISCHE STOFFE UND SCHIMMEL
- RESISTENTE A LOS AGENTES QUÍMICOS Y A LOS MOHOS

## Applicazioni - Applications - Applications - Verlegung - Aplicaciones

- Posa diretta su erba
- Direct installation on grass
- Pose directe sur de l'herbe
- Verlegung direkt auf Rasen
- Colocación directa sobre hierba



- Posa diretta su ghiaia
- Direct installation over gravel
- Pose direct sur du gravier
- Verlegung direkt auf Kies
- Colocación directa sobre grava



- Posa su massetto cementizio
- Installation on sand-cement screed
- Pose sur chape ciment
- Verlegung auf Zement-Unterbetonblock
- Colocación sobre contrapiso de hormigón

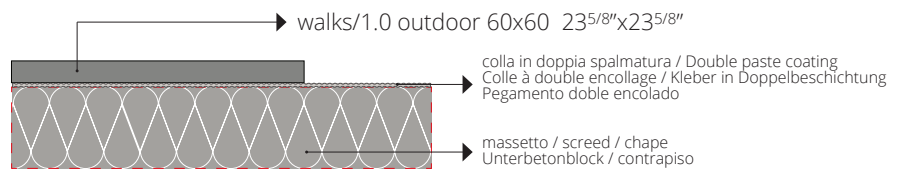

- Posa su piedini fissi o regolabili
- Installation on fixed or adjustable feet
- Pose sur pieds fixes ou réglables
- Verlegung auf feststehende oder regulierbare Füße
- Colocación sobre pies fijos o regulables

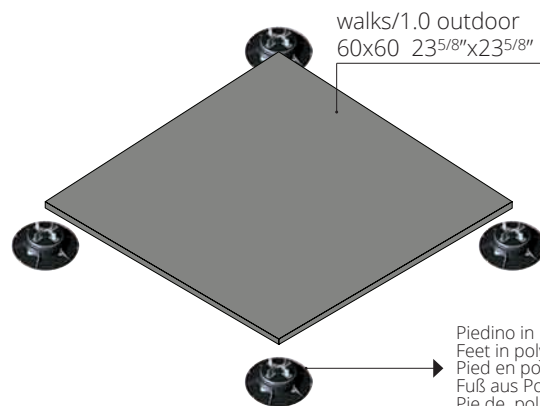

Per le specifiche di utilizzo dei sistemi sopraelevati vedi il sito florim.com  
For the specifics on use of raised systems visit the site florim.com  
Pour les caractéristiques d'utilisation des systèmes surélevés, voir le site florim.com  
Für die Nutzungsbedingungen der Doppelbodensysteme siehe Webseite florim.com  
Para las especificaciones de empleo de los sistemas sobreelevados consulte el sitio web florim.com

Le lastre ceramiche sono sottoposte a un trattamento di compattazione termica che assicura resistenza e durata nel tempo. Il bassissimo assorbimento d'acqua rende perciò il materiale ingelivo. Ciò può comportare ristagni d'acqua superficiali anche per materiale installato a regola d'arte. / Ceramic tiles undergo a compacting thermal treatment that ensures resistance and durability. The low level of water absorption makes the slabs frost resistant. This could result in superficial water stagnations even if materials are installed in a workmanlike manner. / Les carreaux de céramique subissent un traitement thermique de compactage qui assure résistance et durabilité. Le faible niveau d'absorption d'eau rend les dalles résistantes au gel. Il pourrait en résulter des stagnations d'eau superficielles, même si les dalles ont été installées dans les règles de l'art. / Die Keramikplatten werden einer thermischen Verdichtung unterzogen, welche die Widerstandsfähigkeit und Langlebigkeit sichert. Die extrem niedrige Wasseraufnahme macht das Material frostsicher. Die hohe Materialdichte kann, auch bei einer perfekten Verlegung, eine längere Abtrochnungszeit von angestaumtem Wasser zur Folge haben. / Las baldosas cerámicas se someten a un tratamiento de compactación térmica que asegura resistencia y durabilidad. La baja absorción de agua hace que las baldosas resistan al hielo. Esto podría resultar en estancamientos superficiales de agua, incluso si los materiales están instalados según las reglas del arte.



## WHITE



## GRAY



R11

20 mm 3/4" ↑↓

### GRES FINE PORCELLANATO

FINE PORCELAIN STONEWARE/GRES CERAME FIN/FEINSTEINZEUG-KOLLEKTIONEN/GRES PORCELANICO FINO  
SQUADRATO - SQUARED - EQUARRI - REKTIFIZIERT - ESCUADRADO

WALKS/1.0	20 mm 3/4" ↑↓	COLOR	SURFACE	40x120	60x60
				15 <sup>3/4"</sup> x47 <sup>1/4"</sup>	23 <sup>5/8"</sup> x23 <sup>5/8"</sup>
		WHITE	NATURALE	740560 ■ FL-12400	740558 ■ FL-09300
		GRAY	NATURALE	740561 ■ FL-12400	740559 ■ FL-09300

### PEZZI SPECIALI

Special trims/Pièces spéciales/Formstücke  
Piezas especiales  
pag 184/187

	RESISTENZA ALLA FLESSIONE IN N/mm <sup>2</sup> N/mm <sup>2</sup> FLEXURAL STRENGTH TEST / RESISTANCE A LA FLEXION EN N/mm <sup>2</sup> / BIEGEFESTIGKEIT IN N/mm <sup>2</sup> / RESISTENCIA A LA FLEXION EN N/mm <sup>2</sup>	valore medio 52 N/mm <sup>2</sup>
	Forza di rottura in N (sp. > 7,5 mm) Breaking strength in N (thickness > 7,5 mm) / Force de rupture en N (ép. > 7,5 mm) / Bruchlast in N (Dicke > 7,5 mm) / Fuerza de rotura en N (gr. > 7,5 mm)	valore medio 14000 N

WALKS/1.0	scatola - box			pallet		
	pz	mq	kg	box	mq	kg
40x120 20mm	2	0,96	42,86	24	23,04	1060
60x60 20mm	2	0,72	32,15	30	21,60	990



# OUTDOOR 20mm PEZZI SPECIALI

SPECIAL TRIMS  
PIÈCES SPÉCIALES  
FORMSTÜKE  
PIEZAS ESPECIALES



CARATTERISTICHE TECNICHE



TECHNICAL FEATURES  
CARACTÉRISTIQUES TECHNIQUES  
TECHNISCHE EIGENSCHAFTEN  
CARACTERÍSTICAS TÉCNICAS

# Pezzi speciali Outdoor 20mm

Special trims/Pièces spéciales/Formstücke / Piezas especiales

## Collections:

AIRTECH - BUILDTECH/2.0 - EARTHECH  
INDUSTRIAL - STONTECH/4.0 - RAWTECH - WALKS/1.0

## Collections:

AIRTECH - BUILDTECH/2.0 - BIOTECH - CORETECH - EARTHECH  
STONTECH/4.0 - RAWTECH - PLIMATECH

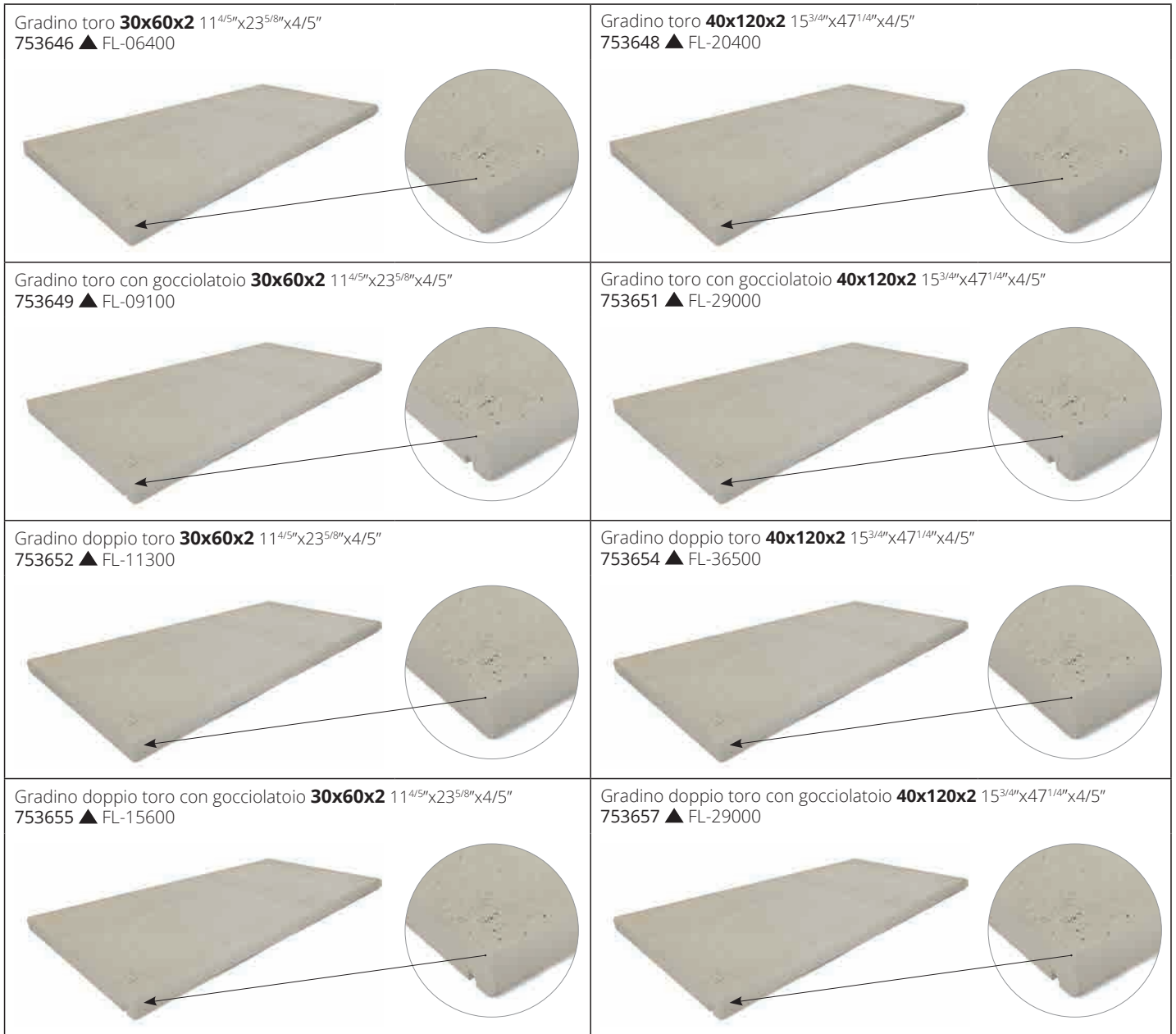

PEZZI SPECIALI OUTDOOR 20mm	scatola - box			pallet		
	pz	mq	kg	box	mq	kg
30x60 gradino toro	1	-	10,00	-	-	-
30x60 gradino toro con gocciolatoio	1	-	10,00	-	-	-
30x60 gradino doppio toro	1	-	10,00	-	-	-
30x60 gradino doppio toro con gocciolatoio	1	-	10,00	-	-	-
40x120 gradino toro	1	-	25,00	-	-	-
40x120 gradino toro con gocciolatoio	1	-	25,00	-	-	-
40x120 gradino doppio toro con gocciolatoio	1	-	25,00	-	-	-
30x60 elemento ad elle	1	-	10,00	-	-	-
30x60 elemento ad elle angolo dx/sx	1	-	10,00	-	-	-
60x60 elemento ad elle	1	-	20,00	-	-	-
60x60 elemento ad elle angolo dx/sx	1	-	20,00	-	-	-
40x120 elemento ad elle	1	-	25,00	-	-	-
40x120 elemento ad elle angolo dx/sx	1	-	25,00	-	-	-

Collections:

AIRTECH - BUILDTECH/2.0 - EARTHECH - INDUSTRIAL  
 STONTECH/4.0 - RAWTECH - WALKS/1.0

Collections:

AIRTECH - BUILDTECH/2.0 - BIOTECH - CORETECH - EARTHECH  
 STONTECH/4.0 - RAWTECH - PLIMATECH

Elemento ad Elle Angolo SX **30x60x8** 11<sup>4/5"</sup>x23<sup>5/8"</sup>x3<sup>1/8"</sup>  
 753852 ▲ FL-14500

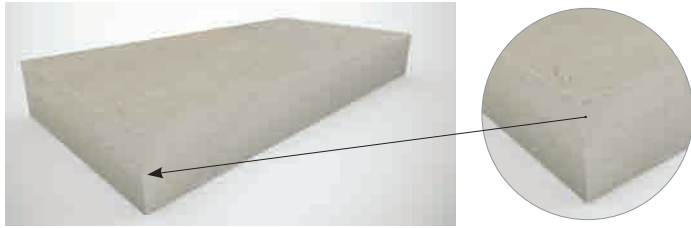

Elemento ad Elle Angolo SX **40x120x8** 15<sup>3/4"</sup>x47<sup>1/4"</sup>x3<sup>1/8"</sup>  
 753861 ▲ FL-29000

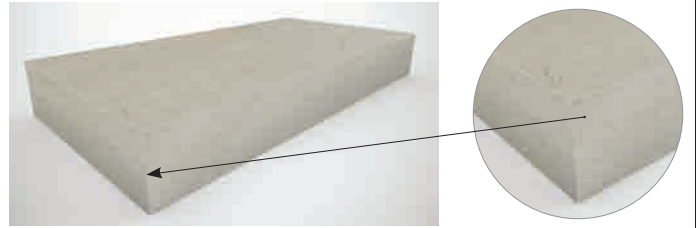

Elemento ad Elle **30x60x8** 11<sup>4/5"</sup>x23<sup>5/8"</sup>x3<sup>1/8"</sup>  
 753850 ▲ FL-09300

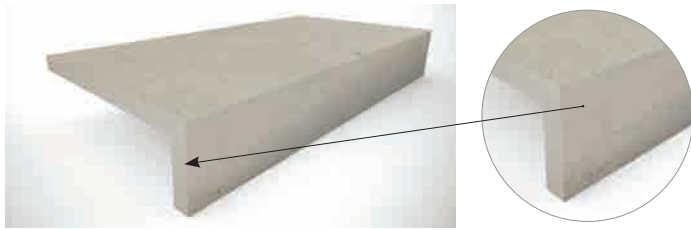

Elemento ad Elle **40x120x8** 15<sup>3/4"</sup>x47<sup>1/4"</sup>x3<sup>1/8"</sup>  
 753859 ▲ FL-19900

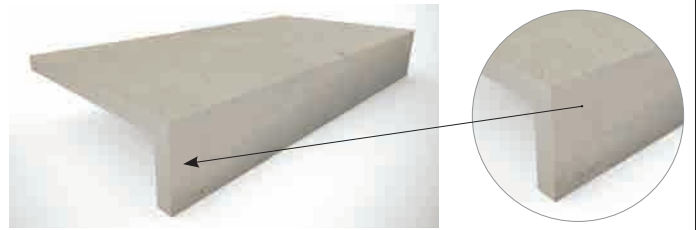

Elemento ad Elle Angolo DX **30x60x8** 11<sup>4/5"</sup>x23<sup>5/8"</sup>x3<sup>1/8"</sup>  
 753851 ▲ FL-14500

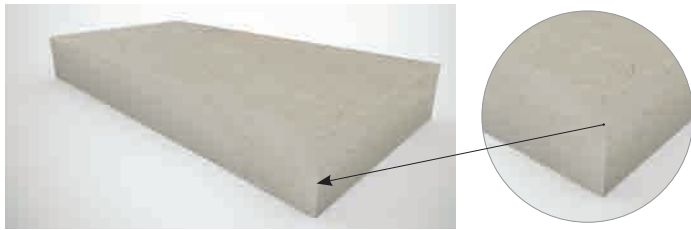

Elemento ad Elle Angolo DX **40x120x8** 15<sup>3/4"</sup>x47<sup>1/4"</sup>x3<sup>1/8"</sup>  
 753860 ▲ FL-29000

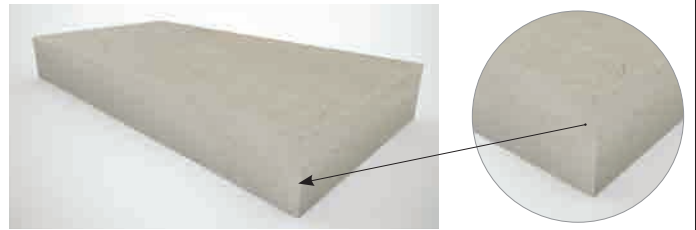

Elemento ad Elle Angolo SX **60x60x8** 23<sup>5/8"</sup>x23<sup>5/8"</sup>x3<sup>1/8"</sup>  
 753855 ▲ FL-19900

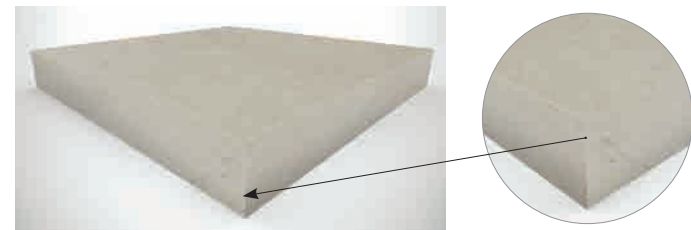

**Pezzi speciali e fondo possono differire in termini di tonalità, il bordo può presentare stratificazioni di tonalità diverse.**

Special pieces and field tiles may come in different shades, the slab's edge may show layers of differing hues.

Il peut y avoir des différences de tonalités entre les pièces spéciales et le fond, le bord pourrait présenter des stratifications de tonalités différentes.

Die Formteile können farblich von der Grundplatte abweichen, ihre Kanten können Schichtungen in unterschiedlichen Farbtönen aufweisen.

Piezas especiales y bases pueden diferir en términos de tonalidad, el borde puede presentar estratificaciones de diferente tonalidad.

Elemento ad Elle **60x60x8** 23<sup>5/8"</sup>x23<sup>5/8"</sup>x3<sup>1/8"</sup>  
 753853 ▲ FL-14000

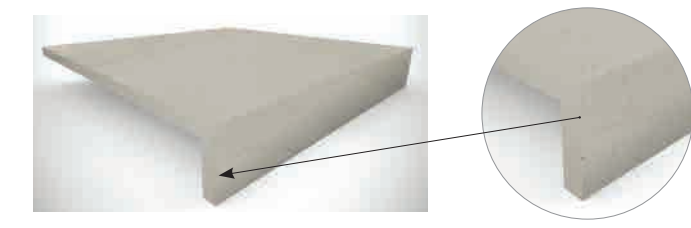

Elemento ad Elle Angolo DX **60x60x8** 23<sup>5/8"</sup>x23<sup>5/8"</sup>x3<sup>1/8"</sup>  
 753854 ▲ FL-19900

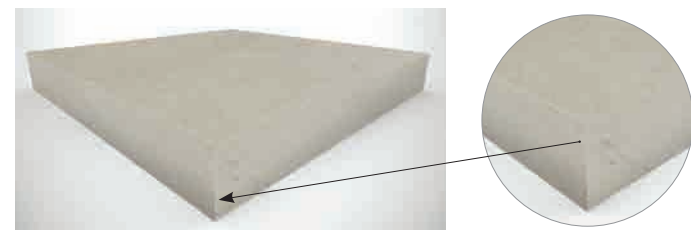



# **BORDO VASCA**

SWIMMING POOL EDGE  
BORD DE PISCINE  
BECKENRAND  
BORDE DE LA TINA



**CARATTERISTICHE TECNICHE**



TECHNICAL FEATURES  
CARACTÉRISTIQUES TECHNIQUES  
TECHNISCHE EIGENSCHAFTEN  
CARACTERÍSTICAS TÉCNICAS

# WAVE/SPECIALPIECES

BORDO VASCA / SWIMMING POOL EDGE / BORD DE PISCINE  
BECKENRAND / BORDE DE LA TINA

WAVE LINEARE	
	
<b>30,5x60</b> 12"x23 <sup>5/8</sup> "	
<b>762862</b>	▲ FL-13400
<b>40,5x80</b> 16"x31 <sup>1/2</sup> "	
<b>769298</b>	▲ FL-21000

WAVE ANGOLO AE	
	
<b>30,5x30,5</b> 12"x12"	
<b>762872</b>	▲ FL-19400
<b>40,5x40,5</b> 16"x16"	
<b>769302</b>	▲ FL-27900

WAVE ANGOLO AI 45°	
	
<b>30,5x60x60</b> 12"x23 <sup>5/8</sup> "x23 <sup>5/8</sup> "	
<b>762867</b>	▲ FL-29000
<b>40,5x80x80</b> 12"x31 <sup>1/2</sup> "x31 <sup>1/2</sup> "	
<b>769303</b>	▲ FL-44100

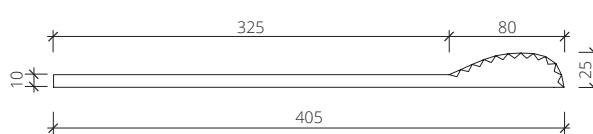
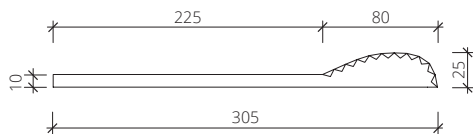

## BORDO PER PISCINA "WAVE"

Rivoluzionario pezzo speciale che, attraverso l'accostamento di una serie di listelli opportunamente conformati su un lato del pezzo, rende ottimale la tracimazione, il contenimento dell'acqua, nonché l'appiglio manuale. La flessibilità progettuale di questo pezzo consente di realizzare bordi con diversi materiali Florim selezionati tra le serie che presentano le più elevate proprietà antiscivolo a piedi nudi (classe A+B+C, rif. norma DIN 51097).

## "WAVE" SWIMMING POOL EDGE

Revolutionary border tile that, by placing together a set of suitably shaped strips on one side of the tile, makes an efficient overflow, containing the water and also offering a hand-grip. The flexibility of the design of this tile enables edges to be created with different Florim materials selected from the ranges that have the highest barefoot slip-resistance ratings (Class A+B+C, according to DIN 51097 standard).

## BORD POUR PISCINE « WAVE »

Pièce spéciale révolutionnaire qui, grâce à la juxtaposition d'une série de listels dûment disposés sur un côté de la pièce, optimise le débordement, le confinement de l'eau, ainsi que le point d'accroche avec les mains. La flexibilité de conception de cette pièce permet de réaliser des bords avec différents matériaux Florim sélectionnés parmi les séries dotées des plus hautes propriétés antidérapantes pieds nus (classe A+B+C, réf. norme DIN 51097).

## BECKENRANDSTEIN "WAVE"

Ein revolutionäres Spezialteil, das durch das Aneinandersetzen einer Reihe von Leisten, die an einer Seite des Spezialteils zweckmäßig geformt sind, eine ausgezeichnete Überflutung, Wassereindämmung und Griffkante bietet. Die flexible Projektanpassung dieses Spezialteils erlaubt die Gestaltung von Beckenrändern mit verschiedenen Florim-Materialien, ausgewählt unter den Produktserien mit der höchsten Barfuß-Rutschfestigkeit (Klasse A+B+C, Bezugsnorm DIN 51097).

## BORDE PARA PISCINA «WAVE»

Pieza especial revolucionaria que se remata por un lado con una serie de listones de forma especial, para ofrecer un desbordamiento y retención del agua óptimos, así como un excelente asidero manual. La flexibilidad de diseño de esta pieza permite realizar bordes con varios materiales de Florim, seleccionados entre las series que presentan las más altas propiedades antideslizantes con pies descalzos (clase A+B+C, ref. norma DIN 51097).

# OCEAN/SPECIALPIECES

BORDO VASCA / SWIMMING POOL EDGE / BORD DE PISCINE  
BECKENRAND / BORDE DE LA TINA

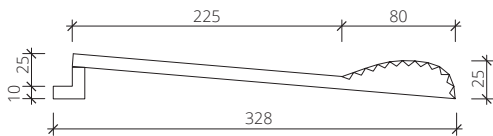

## BORDO PER PISCINA "OCEAN"

Innovativo e rivoluzionario pezzo speciale progettato appositamente per essere utilizzato come bordo piscina con sistema ad acqua traboccante a sfioro. E' composto da un pezzo che, attraverso l'accostamento di una serie di listelli opportunamente conformati su un lato del pezzo, rende ottimale la tracimazione, il contenimento dell'acqua, nonché l'appiglio manuale. La flessibilità progettuale di questo pezzo consente di realizzare bordi con diversi materiali Florim selezionati tra le serie che presentano le più elevate proprietà antiscivolo a piedi nudi (classe A+B+C, rif. norma DIN 51097). Questo pezzo speciale comprende anche l'angolare in porcellanato per appoggio e contenimento griglia.

## "OCEAN" SWIMMING POOL EDGE

Innovative, revolutionary border tile specially designed to be used as a swimming pool edge with overflow system. It comprises a piece that, by placing together a set of suitably shaped strips on one side of the tile, makes an efficient overflow, containing the water and also offering a hand-grip. The flexibility of the design of this tile enables edges with different Florim materials to be created, selecting them from the ranges that have the highest barefoot slip-resistance ratings (Class A+B+C, according to DIN 51097 standard). This special piece also includes the porcelain stoneware corner element for setting and containing the grating.

## BORD POUR PISCINE « OCEAN »

Pièce spéciale innovante et révolutionnaire spécialement conçue pour être utilisée comme bord de piscine à débordement avec système de trop-plein. Grâce à la juxtaposition d'une série de listels dûment disposés sur un de ses côtés, cette pièce, optimise le débordement, le confinement de l'eau, ainsi que le point d'accroche avec les mains. La flexibilité de conception de cette pièce permet de réaliser des bords avec différents matériaux Florim sélectionnés parmi les séries dotées des plus hautes propriétés antidérapantes pieds nus (classe A+B+C, réf. norme DIN 51097). Cette pièce spéciale comprend également une pièce d'angle en grès cérame pour le support et le confinement de la grille.

## BECKENRANDSTEIN "OCEAN"

Dieses innovative und revolutionäre Spezialteil wurde speziell für die Verwendung als Rand für Schwimmbecken mit Wasserüberlauftrinne entwickelt. Es besteht aus einem Teil, das durch das Aneinandersetzen einer Reihe von Leisten, die an einer Seite des Teils zweckmäßig geformt sind, eine ausgezeichnete Überflutung, Wassereindämmung und Griffkante bietet. Die flexible Projektanpassung dieses Spezialteils erlaubt die Gestaltung von Beckenrändern mit verschiedenen Florim-Materialien, ausgewählt unter den Produktserien mit der höchsten Barfuß-Rutschfestigkeit (Klasse A+B+C, Bezugsnorm DIN 51097). Dieses Spezialteil enthält auch das Eckstück aus Feinsteinzeug zur Aufnahme des Rostes.

## BORDE PARA PISCINA «OCEAN»

Pieza especial, innovadora y revolucionaria, diseñada específicamente para usarse como borde de piscina con sistema de agua desbordante. Consta de una pieza que se remata por un lado con una serie de listones de forma especial, para ofrecer un desbordamiento y retención del agua óptimos, así como un excelente asidero manual. La flexibilidad de diseño de esta pieza permite realizar bordes con varios materiales de Florim, seleccionados entre las series que presentan las más altas propiedades antideslizantes con pies descalzos (clase A+B+C, ref. norma DIN 51097). Esta pieza especial también incluye la pieza angular de porcelánico de apoyo y sujeción de la rejilla.







FLORIM OVERSIZE  
**magnUm**<sup>®</sup>

## **IMBALLI E DECORI**

PACKAGING AND DECORATIONS  
EMBALLAGES ET DÉCORS  
VERPACKUNGEN UND DEKORS  
EMBALAJES Y DECORACIONES

# TABELLA IMBALLI

PACKAGE TABLE/TABLEAU DE EMBALLAGES/TABELLE FORMATE/TABLA DE LOS EMBALAJES  
#6 SPESSORE / THICKNESS/ÉPAISSEUR/STÄRKE/ESPESOR

			BOXES 				PALLET 		
			ML	PZ	MQ	KG	BOX	MQ	KG
	<b>80x80</b>	31 1/2"x31 1/2"	-	3	1,92	27,80	40	76,80	1140
	<b>60x120</b>	23 5/8"x47 1/4"	-	3	2,16	31,30	30	64,80	960
<b>MOSAICO 1,5x3</b>	<b>30x30</b>	11 4/5"x11 4/5"	-	11	1,00	16,50	-	-	-
	<b>30x30</b>	11 4/5"x11 4/5"	-	11	1,00	16,50	-	-	-
	<b>30x30</b>	11 4/5"x11 4/5"	-	11	1,00	16,50	-	-	-
<b>MURETTO 7,5x15</b>	<b>30x30</b>	11 4/5"x11 4/5"	-	11	1,00	16,50	-	-	-
	<b>30x30</b>	11 4/5"x11 4/5"	-	11	1,00	16,50	-	-	-
<b>BATTISCOPIA</b>	<b>4,6x80</b>	1 4/5"x31 1/2"	14,40	18	-	8,60	-	-	-
	<b>4,6x60</b>	1 4/5"x23 5/8"	14,40	24	-	8,60	-	-	-

## DECORI/ DECORS

Note Imballo. Tutti i singoli pezzi tagliati vengono numerati con applicazione sulla parte a vista di un pezzo di nastro isolante dove è riportato il n° del pezzo. Le scatole sono rivestite internamente di polistirolo per garantire l'integrità dei singoli pezzi. Su ogni scatola è riportato: N° dei pezzi totali - Numerazione di ciascun pezzo. Sulla paletta viene applicata una pallet card ed una busta in plastica contenente lo schema di montaggio. Per richieste di formati inferiori al modulo base (120x240 o 160x240), resta in vigore la richiesta di lavorazioni fuori standard. N. B. Il prezzo di listino del decoro si riferisce a formato standard. Eventuali lavorazioni su misura verranno valutate su richiesta. (Il servizio clienti è a disposizione per informazioni e ulteriori dettagli a riguardo).

Packing notes. Each individual cut piece is given a number. The piece number is shown on the exposed side of a strip of insulation tape. The boxes are padded on the inside with polystyrene to protect the individual pieces. Each box bears the following information: Total n° of pieces - Code number of each piece. The pallet comes with a pallet card and a plastic pouch containing the assembly diagram. For smaller sizes requests different from basic modules (120x240 or 160x240), you need to follow the procedure for requesting a non-standard format. N. B. The decor's price list refers to the standard format featuring one colour. Any custom-work will be assessed upon request. Please call our Customer Service for more information.

Remarques concernant l'emballage. Chaque pièce découpée est numérotée avec une application sur la partie visible d'un morceau de ruban isolant sur lequel figure le n° de la pièce. Les boîtes sont revêtues intérieurement de polystyrène afin de garantir l'intégrité de chaque pièce. Sur chaque boîte figurent: le nombre de pièces totales et la numérotation de chaque pièce. Une carte de la palette et un sachet en plastique contenant le schéma du montage sont appliqués sur la palette. Pour toute demande de formats inférieurs au module de base (120x240 ou 160x240), reste en vigueur la demande de hors standard. N. B. Le prix catalogue du décor se réfère au format standard. Les éventuels traitements sur mesure seront évalués sur demande. Le service clientèle est à votre disposition si vous avez besoin d'informations et de plus amples détails.

Verpackungshinweise. Alle geschneittenen einzelnen Teile werden nummeriert, wobei die Nummer des Teils auf der sichtbaren Seite eines Stücks Isolierband angebracht ist. Die Kartonverpackungen sind innen mit Polystyrol ausgelegt, um die Unversehrtheit der einzelnen Teile zu gewährleisten. Folgende Angaben befinden sich auf jedem Karton: Gesamtzahl der Teile Nummerierung jedes Teils. An der Palette sind eine Palettenkarte und ein Kunststoffbeutel mit dem Montageplan angebracht. Für Anfragen von kleineren Formaten als vom Standard vorgesehen (120x240 oder 160x240) gilt der übliche Bearbeitungsverfahren für Sonderanfertigungen. N. B. Der Listenpreis bezieht sich auf die Dekoration im Standard-Format, einfarbig. Eventuelle kundenspezifische Verarbeitungen werden auf Anfrage kalkuliert. Der Kundenservice steht für weitere Informationen und Einzelheiten hierzu jederzeit zur Verfügung.

Notas sobre el embalaje. Todas las partes cortadas se enumeran colocando en la parte a la vista de la pieza una cinta adhesiva donde se reproduce el n.º de la pieza. El interior de las cajas se reviste con poliestireno para garantizar la integridad de cada una de las piezas. Sobre cada caja se reproduce: N.º de las piezas totales - Numeración de cada pieza. En la paleta se coloca una "pallet card" y una bolsa plástica que contiene el esquema del montaje. Para pedidos de formatos inferiores a los módulos de base (120x240 o 160x240), es necesario solicitar las elaboraciones no estándar. N. B. El precio de catálogo del decoro se refiere al formato estándar. Las elaboraciones a medida se evaluarán bajo pedido. El servicio de atención al cliente está a su disposición para proporcionarle más información y detalles al respecto.

Listino IMBALLI / Price List PACKAGING	
TIPO / TYPE	PREZZO / PRICE
<b>A: CASSA / CRATE</b> cm 175x340x31h - 68 <sup>8/9</sup> "x133 <sup>6/7</sup> "x12 <sup>1/5</sup> "	230,00 €
<b>B: CASSA / CRATE</b> cm 145x292x35h - 57"x115"x13 <sup>7/9</sup> "	160,00 €
<b>C: CASSA / CRATE</b> cm 136x263x34h - 53 <sup>1/2</sup> "x103 <sup>1/2</sup> "x13 <sup>2/5</sup> "	160,00 €
<b>D: CASSA / CRATE</b> cm 135x144x41h - 53 <sup>1/7</sup> "x56 <sup>2/3</sup> "x16 <sup>1/7</sup> "	-
<b>E: CASSA / CRATE</b> cm 135x144x66h - 53 <sup>1/7</sup> "x56 <sup>2/3</sup> "x26"	-
<b>G: CASSA / CRATE</b> cm 174x183x41h - 68 <sup>1/2</sup> "x72x16 <sup>1/7</sup> "	160,00 €
<b>H/I: CAVALLETTO / A-FRAME</b> cm 73x330x200h - 28 <sup>3/4</sup> "x130"x78 <sup>3/4</sup> "	360,00 €
<b>L: CAVALLETTO / A-FRAME</b> cm 75x339x186h - 29 <sup>1/2</sup> "x133 <sup>1/2</sup> "x73 <sup>2/9</sup> "	500,00 €
<b>M: CAVALLETTO / A-FRAME</b> cm 75x290x146h - 29 <sup>1/2</sup> "x114 <sup>1/6</sup> "x57 <sup>1/2</sup> "	450,00 €
<b>N: CAVALLETTO / A-FRAME</b> cm 75x250x146h - 29 <sup>1/2</sup> "x98 <sup>3/7</sup> "x57 <sup>1/2</sup> "	380,00 €
<b>P: CAVALLETTO / A-FRAME</b> cm 75x250x160h - 29 <sup>1/2</sup> "x98 <sup>3/7</sup> "x63"	280,00 €
<b>R: CAVALLETTO / A-FRAME</b> cm 75x170x195h - 29 <sup>1/2</sup> "x67"x76 <sup>7/9</sup> "	280,00 €

\*Le lastre sono contenute in scatole da 2 pezzi ciascuna / Packing for this item is 2 slabs per box / Les plaques sont contenues dans des boîtes de 2 pièces chacune . Die Platten sind in Kartons zu je 2 Stück verpackt. / Las baldosas están empaquetadas en cajas de 2 piezas cada una.

°per spedizioni > 12 scatole / for shipments > 12 boxes / pour les expéditions > 12 boîtes / für Versandmengen > 12 Schachteln / para envíos > 12 cajas.

°°per spedizioni ≤ 12 scatole / for shipments ≤ 12 boxes / pour les expéditions ≤ 12 boîtes / für Versandmengen ≤ 12 Schachteln / para envíos ≤ 12 cajas

# TABELLA IMBALLI

## PACKAGE TABLE/TABLEAU DE EMBALLAGES/TABELLE FORMATE/TABLA DE LOS EMBALAJES #6 SPESSORE / THICKNESS/ÉPAISSEUR/STÄRKE/ESPESOR

TIPO TYPE	formato LASTRA SLAB size	LASTRA SLAB		CASSA vuota empty CRATE			CASSA piena full CRATE	CAVALLETTO vuoto empty A-Frame			CAVALLETTO pieno full A-Frame
		MQ	KG	PZ	MQ	KG	KG	PZ	MQ	KG	KG
	<b>A</b> <b>160x320</b> 63"x126"	5,12	74,15	14	71,68	140,5	1178,6	-	-	-	-
	<b>B</b> <b>120x280</b> 47 <sup>1/4</sup> "x110 <sup>1/4</sup> "	3,36	48,65	20	67,20	90,00	1063	-	-	-	-
	<b>C (6mm)</b> <b>120x240</b> 47 <sup>1/4</sup> "x94 <sup>1/2</sup> "	2,88	41,70	20	57,60	107,00	941	-	-	-	-
	<b>C (9mm)</b> <b>120x240</b> 47 <sup>1/4</sup> "x94 <sup>1/2</sup> "	2,88	69,50	14	40,32	107,00	1080	-	-	-	-
	<b>D (6mm)</b> <b>120x120</b> 47 <sup>1/4</sup> "x47 <sup>1/4</sup> "	1,44	20,85	24*	34,56	50,00	550	-	-	-	-
	<b>D (9mm)</b> <b>120x120</b> 47 <sup>1/4</sup> "x47 <sup>1/4</sup> "	1,44	33,28	18*	25,92	50,00	649	-	-	-	-
	<b>E (6mm)</b> <b>120x120</b> 47 <sup>1/4</sup> "x47 <sup>1/4</sup> "	1,44	20,70	48*	69,12	70	1065,1	-	-	-	-
	<b>E (9mm)</b> <b>120x120</b> 47 <sup>1/4</sup> "x47 <sup>1/4</sup> "	1,44	23,11	36*	51,84	70	903,34	-	-	-	-
	<b>G</b> <b>160x160</b> 63"x63"	2,56	37,06	24	61,44	45,00	934,44	-	-	-	-
	<b>H</b> <b>160x320</b> 63"x126"	5,12	74,15	-	-	-	-	44	225,28	220,00	3482,6
	<b>I</b> <b>120x280</b> 47 <sup>1/4</sup> "x110 <sup>1/4</sup> "	3,36	48,65	-	-	-	-	44	147,84	220,00	2360,6
	<b>L</b> <b>160x320</b> 63"x126" Cavalletto in lamiera zincata Zinc-plated sheet A-frame	5,12	74,15	-	-	-	-	44	225,28	120,00	3382,6
	<b>M</b> <b>120x280</b> 47 <sup>1/4</sup> "x110 <sup>1/4</sup> " Cavalletto in lamiera zincata Zinc-plated sheet A-frame	3,36	48,65	-	-	-	-	44	147,84	108,5	2249,1
	<b>N (6mm)</b> <b>120x240</b> 47 <sup>1/4</sup> "x94 <sup>1/2</sup> " Cavalletto in lamiera zincata Zinc-plated sheet A-frame	2,88	41,70	-	-	-	-	44	126,72	92,5	1941,5
	<b>N (9mm)</b> <b>120x240</b> 47 <sup>1/4</sup> "x94 <sup>1/2</sup> " Cavalletto in lamiera zincata Zinc-plated sheet A-frame	2,88	69,50	-	-	-	-	28	80,64	92,5	2038,5
	<b>P (6mm)</b> <b>120x240</b> 47 <sup>1/4</sup> "x94 <sup>1/2</sup> "	2,88	41,70	-	-	-	-	44	126,72	170,00	2004,8
	<b>P (9mm)</b> <b>120x240</b> 47 <sup>1/4</sup> "x94 <sup>1/2</sup> "	2,88	69,50	-	-	-	-	28	80,64	170,00	2116
	<b>R</b> <b>160x160</b> 63"x63"	2,56	37,07	-	-	-	-	44	112,64	160,00	1791,08



## ESEMPI DI PERSONALIZZAZIONE DECORI IN DIMENSIONE 120X240

EXAMPLES OF DECORS CUSTOMIZATIONS 120X240 SIZE

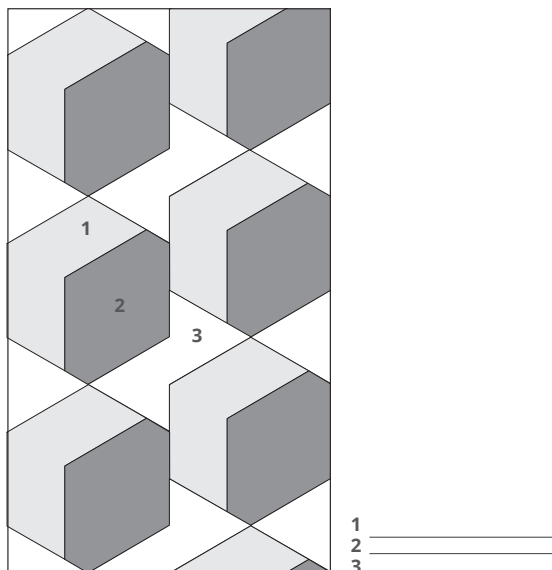

In ogni decoro è possibile selezionare materie e superfici combinandole nel modo in cui si desidera (vedi esempio).  
Il decoro può essere adattato a qualsiasi misura richiesta.

For each decor you can select materials and surfaces combining them in the way you prefer (see example).  
The decoration can be adapted to any requested measurements.

### ABBINAMENTI CONSIGLIATI.

SUGGESTED COMBINATIONS.

#### INDUSTRIAL

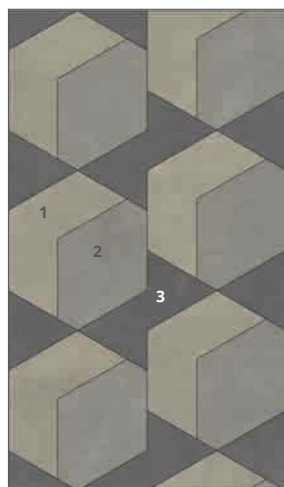

FLA / 749488 ■ FL-58900

1/ INDUSTRIAL / SAGE  
2/ INDUSTRIAL / STEEL  
3/ INDUSTRIAL / PLOMB

#### FLOWTECH



FLOWTECH / AGED BRONZE

**ESEMPI DI PERSONALIZZAZIONE DECORI**  
**EXAMPLES OF DECORS CUSTOMIZATIONS**

**FLOWTECH  
INDUSTRIAL**

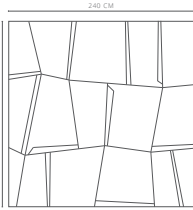

**FLB / 749489 ■ FL-58900**

1/ **FLOWTECH** / BURNISHED  
2/ **INDUSTRIAL** / PLOMB

**INDUSTRIAL**

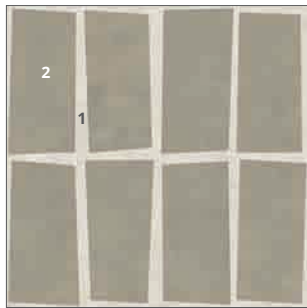

**FLC / 749490 ■ FL-58900**

1/ **INDUSTRIAL** / IVORY  
2/ **INDUSTRIAL** / SAGE

**BIOTECH**



**FLE A/B/C / 750220 ■ FL-58900**

**BIOTECH / LAPIS GREIGE**

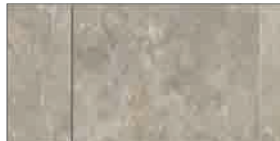

**FLE A / 749497 ■ FL-58900**



**FLE B / 749498 ■ FL-58900**



**FLE C / 749499 ■ FL-58900**

# ESEMPI DI PERSONALIZZAZIONE DECORI IN DIMENSIONE 160X240

EXAMPLES OF DECORS CUSTOMIZATIONS 160X240 SIZE

## INDUSTRIAL



**FLD A/B/C/D/E/F/ 750219**  
■ FL-58900

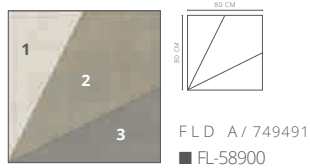

1/ INDUSTRIAL / IVORY  
2/ INDUSTRIAL / SAGE  
3/ INDUSTRIAL / STEEL

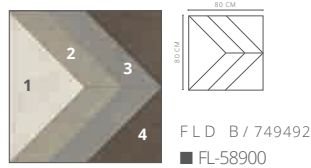

1/ INDUSTRIAL / IVORY  
2/ INDUSTRIAL / SAGE  
3/ INDUSTRIAL / STEEL  
4/ INDUSTRIAL / MOKA

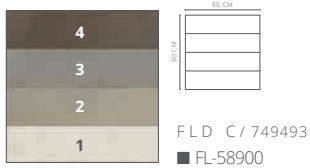

1/ INDUSTRIAL / IVORY  
2/ INDUSTRIAL / SAGE  
3/ INDUSTRIAL / STEEL  
4/ INDUSTRIAL / MOKA

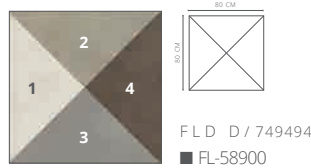

1/ INDUSTRIAL / IVORY  
2/ INDUSTRIAL / SAGE  
3/ INDUSTRIAL / STEEL  
4/ INDUSTRIAL / MOKA

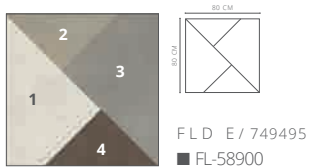

1/ INDUSTRIAL / IVORY  
2/ INDUSTRIAL / SAGE  
3/ INDUSTRIAL / STEEL  
4/ INDUSTRIAL / MOKA

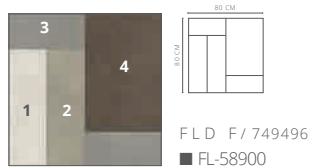

1/ INDUSTRIAL / IVORY  
2/ INDUSTRIAL / SAGE  
3/ INDUSTRIAL / STEEL  
4/ INDUSTRIAL / MOKA

## BUILDTECH/2.0 INDUSTRIAL

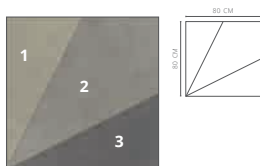

1/ INDUSTRIAL / SAGE  
2/ INDUSTRIAL / STEEL  
3/ INDUSTRIAL / PLOMB

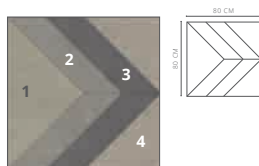

1/ INDUSTRIAL / SAGE  
2/ INDUSTRIAL / STEEL  
3/ INDUSTRIAL / PLOMB  
4/ BUILDTECH/2.0 / BUILD MUD CE

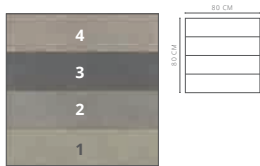

1/ INDUSTRIAL / SAGE  
2/ INDUSTRIAL / STEEL  
3/ INDUSTRIAL / PLOMB  
4/ BUILDTECH/2.0 / BUILD MUD CE

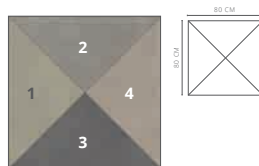

1/ INDUSTRIAL / SAGE  
2/ INDUSTRIAL / STEEL  
3/ INDUSTRIAL / PLOMB  
4/ BUILDTECH/2.0 / BUILD MUD CE

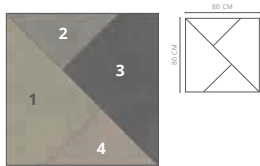

1/ INDUSTRIAL / SAGE  
2/ INDUSTRIAL / STEEL  
3/ INDUSTRIAL / PLOMB  
4/ BUILDTECH/2.0 / BUILD MUD CE

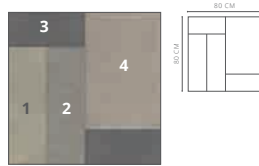

1/ INDUSTRIAL / SAGE  
2/ INDUSTRIAL / STEEL  
3/ INDUSTRIAL / PLOMB  
4/ BUILDTECH/2.0 / BUILD MUD CE

**ESEMPI DI PERSONALIZZAZIONE DECORI IN DIMENSIONE 120X240**  
**EXAMPLES OF DECORS CUSTOMIZATIONS 120X240 SIZE**

**BIOTECH**



**FLF / 749500 ■ FL-58900**

**BIOTECH / CREMA STONE**

**INDUSTRIAL**



**FLG / 749501 ■ FL-58900**

**1/ INDUSTRIAL / STEEL**  
**2/ INDUSTRIAL / PLOMB**

**INDUSTRIAL**

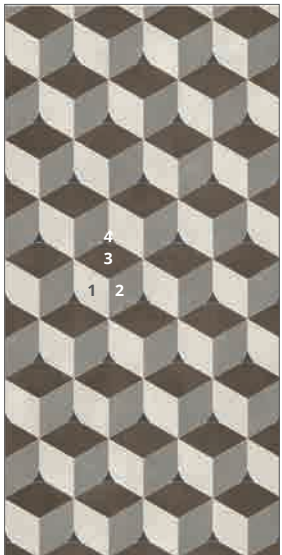

**FLH / 749502 ■ FL-58900**

**1/ INDUSTRIAL / IVORY**  
**2/ INDUSTRIAL / STEEL**  
**3/ INDUSTRIAL / MOKA**  
**4/ INDUSTRIAL / PLOMB**

**INDUSTRIAL**



**FLI / 749503 ■ FL-58900**

**1/ INDUSTRIAL / SAGE**  
**2/ INDUSTRIAL / STEEL**



**ESEMPI DI PERSONALIZZAZIONE DECORI IN DIMENSIONE 120X240**

EXAMPLES OF DECORS CUSTOMIZATIONS 120X240 SIZE

**BUILDTECH/2.0**

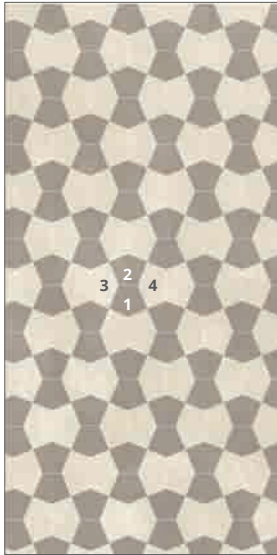

**FLL / 749504 ■ FL-58900**

- 1/ BUILDTECH/2.0 / BUILD MUD CE
- 2/ BUILDTECH/2.0 / BUILD MUD CE
- 3/ BUILDTECH/2.0 / BUILD WHITE CE
- 4/ BUILDTECH/2.0 / BUILD WHITE CE

**BUILDTECH/2.0**

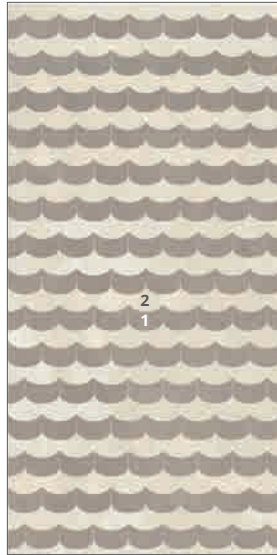

**FLM / 749505 ■ FL-58900**

- 1/ BUILDTECH/2.0 / BUILD MUD CE
- 2/ BUILDTECH/2.0 / BUILD WHITE CE

**INDUSTRIAL  
BIOTECH**

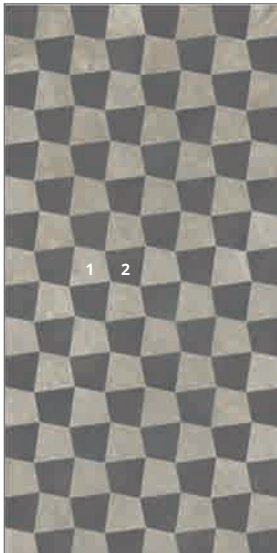

**FLN / 749506 ■ FL-58900**

- 1/ BIOTECH / LAPIS GREIGE
- 2/ INDUSTRIAL / PLOMB

**INDUSTRIAL**



**FLO / 749507 ■ FL-58900**

- 1/ INDUSTRIAL / MOKA
- 2/ INDUSTRIAL / TAUPE
- 3/ INDUSTRIAL / IVORY

## ESEMPI DI PERSONALIZZAZIONE DECORI

EXAMPLES OF DECORS CUSTOMIZATIONS

### BUILDTECH/2.0

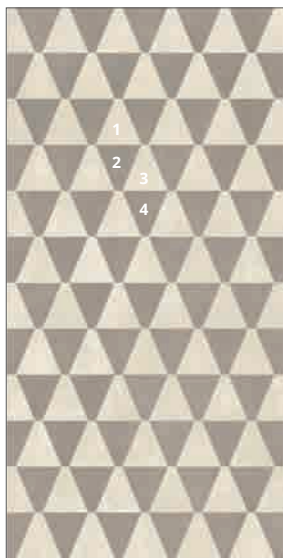

FLP / 749508 ■ FL-58900

- 1/ BUILDTECH/2.0 / BUILD WHITE CE
- 2/ BUILDTECH/2.0 / BUILD MUD CE
- 3/ BUILDTECH/2.0 / BUILD WHITE CE
- 4/ BUILDTECH/2.0 / BUILD MUD CE

## ESEMPI DI PERSONALIZZAZIONE DECORI IN DIMENSIONE 265X240

EXAMPLES OF DECORS CUSTOMIZATIONS 265X240 SIZE

### INDUSTRIAL / BUILDTECH/2.0

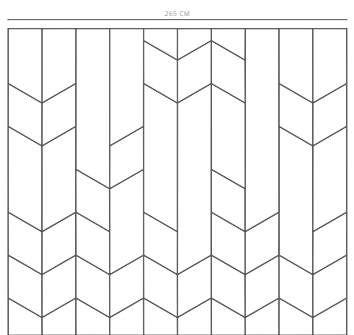
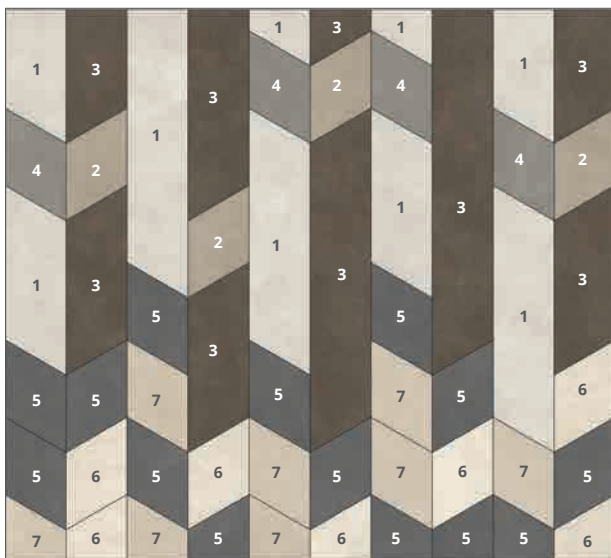

FLQ / 749509 ■ FL-58900

- 1/ INDUSTRIAL / IVORY
- 2/ INDUSTRIAL / TAUPE
- 3/ INDUSTRIAL / MOKA
- 4/ INDUSTRIAL / STEEL
- 5/ INDUSTRIAL / PLOMB
- 6/ BUILDTECH/2.0 / BUILD WHITE CE
- 7/ BUILDTECH/2.0 / BUILD BONE CE

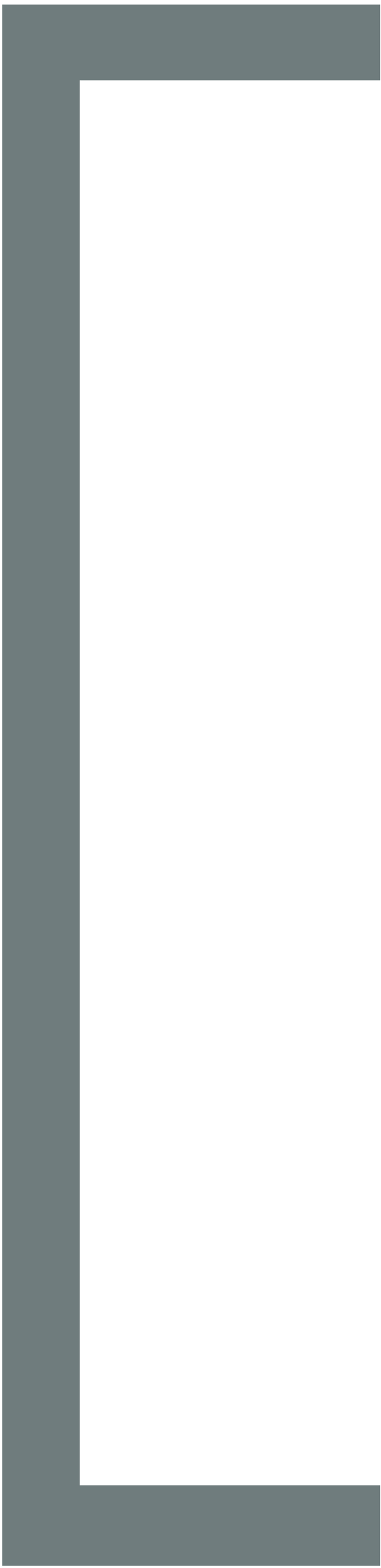

FLORIM OVERSIZE  
**magnUm**<sup>®</sup>

MODERN DESIGN  
PERSPECTIVES ARE  
CHANGING: AMAZING  
SIZES IN A THICKNESS  
OF JUST 6 MM,  
LIGHT, VERSATILE  
AND STRONG, WITH  
EXTRAORDINARY  
AESTHETIC APPEAL.

**GRAPHICS**



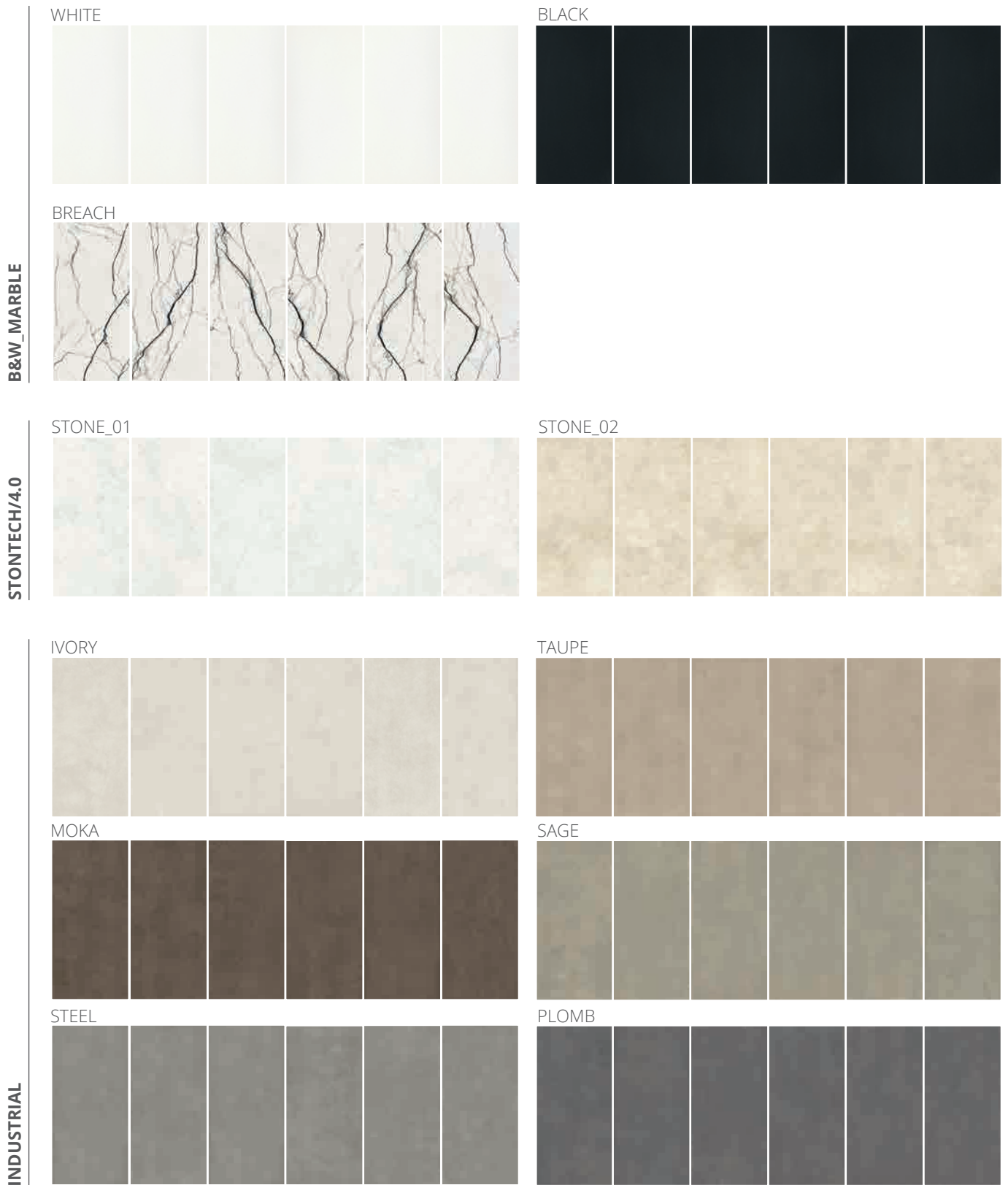

**Le immagini riportate non rappresentano necessariamente il numero di grafiche del prodotto. Il numero di grafiche è variabile in funzione del formato e del colore di riferimento.**  
 Images do not necessarily represent the number of patterns in the product's range. The number of different patterns varies according to size and color of the item. / Les images reportées ne représentent pas forcément le nombre de graphismes du produit. Leur nombre varie en fonction du format et de la couleur choisie. / Die Abbildungen geben keine bindende Auskunft bzgl. der Anzahl verschiedener Grafiken. Die Anzahl der Grafiken ist abhängig von Format und Farbe der jeweiligen Kollektion. / Las imágenes mostradas no representan necesariamente el número de gráficas del producto. El número de gráficas varía en función del formato y del color.

FLOWTECH

RUSSET



AGED BRONZE



BURNISHED



RAWTECH

RAW-WHITE



RAW-DUST



BIOTECH

CREMA STONE



STONEWOOD



LAPIS GREIGE



SERIZZO STONE



SOAP STONE



PLIMAWHITE/01



PLIMAWHITE/02

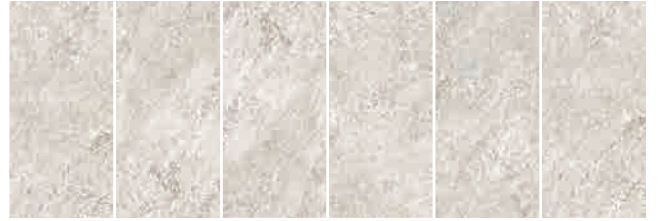

PLIMAWHITE/03

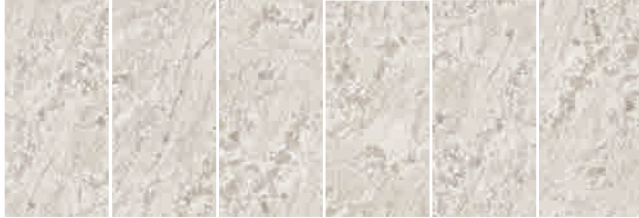

PLIMABEIGE/01



PLIMABEIGE/02



PLIMABEIGE/03



PLIMAGRAY/01



PLIMAGRAY/02



PLIMAGRAY/03

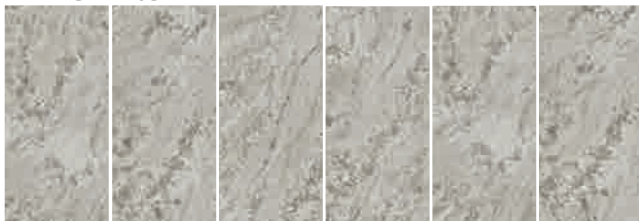

PLIMATECH

**Le immagini riportate non rappresentano necessariamente il numero di grafiche del prodotto. Il numero di grafiche è variabile in funzione del formato e del colore di riferimento.**  
 Images do not necessarily represent the number of patterns in the product's range. The number of different patterns varies according to size and color of the item. / Les images reportées ne représentent pas forcément le nombre de graphismes du produit. Leur nombre varie en fonction du format et de la couleur choisis. / Die Abbildungen geben keine bindende Auskunft bzgl. der Anzahl verschiedener Grafiken. Die Anzahl der Grafiken ist abhängig von Format und Farbe der jeweiligen Kollektion. / Las imágenes mostradas no representan necesariamente el número de gráficas del producto. El número de gráficas varía en función del formato y del color.

FLAME LIGHT



BRUSHED LIGHT

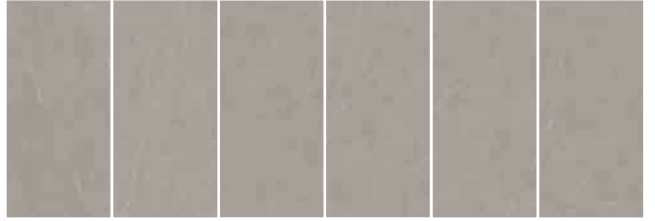

SATIN DARK



FLAME DARK





BUILD\_WHITE CE

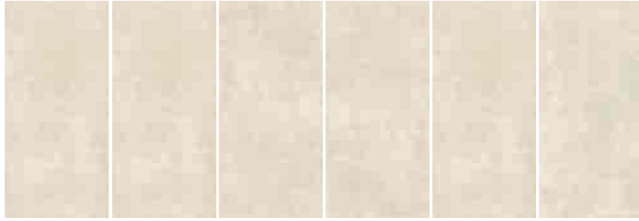

BUILD\_BONE CE



BUILD\_MUD CE

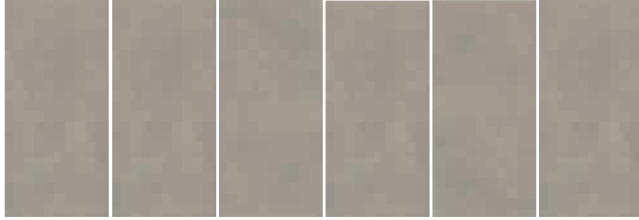

BUILD\_COAL CE



CREAM



MUSTARD

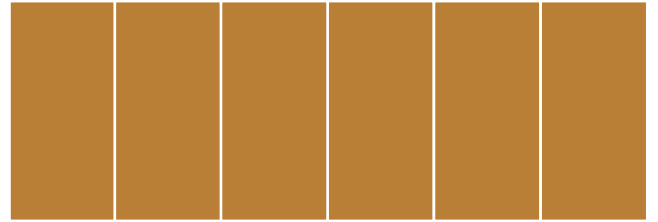

SCARLET

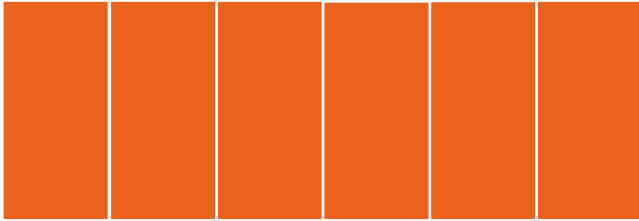

CRIMSON

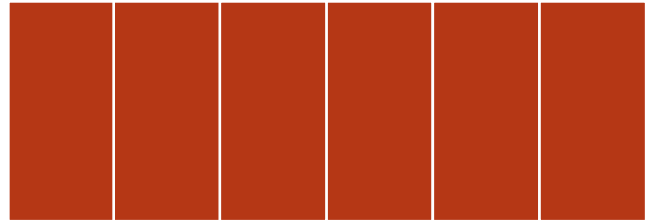

FUCHSIA

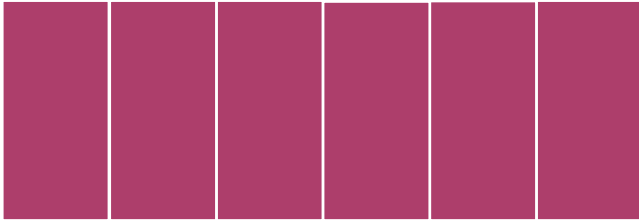

BURGUNDY

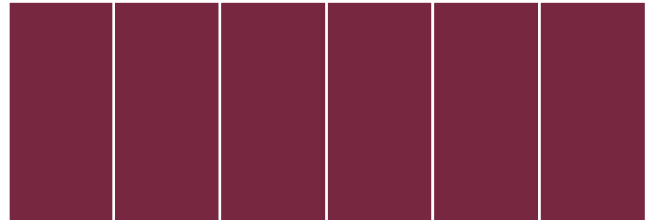

SKY

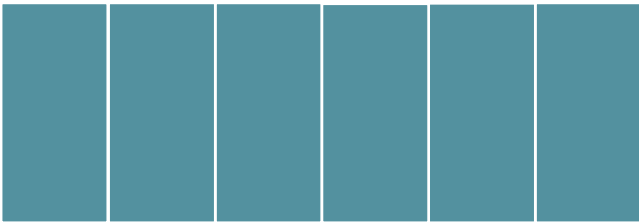

MIDNIGHT

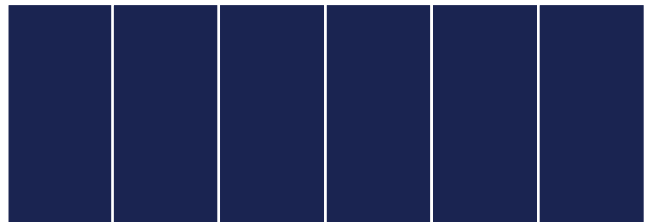

TEAL

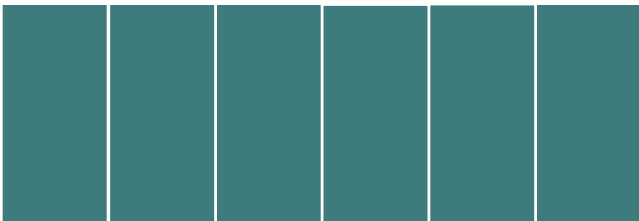

BOTTLE

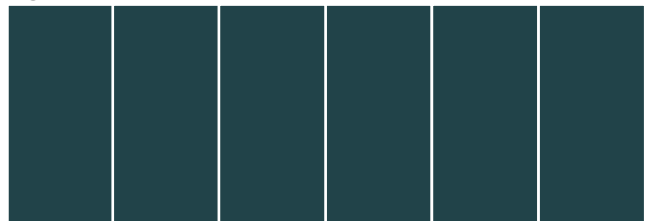

PUMICE\_GROUND

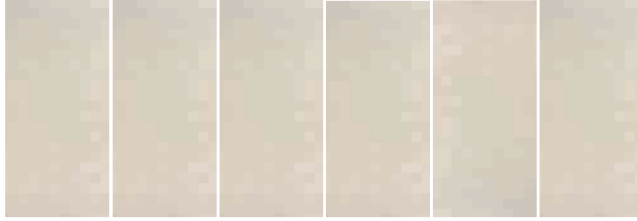

PUMICE\_FLAKES



DESERT\_GROUND



DESERT\_FLAKES



FOG\_GROUND



FOG\_FLAKES

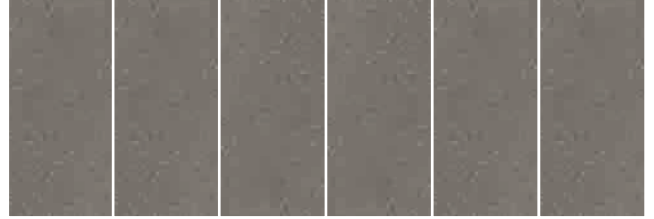

CARBON\_GROUND

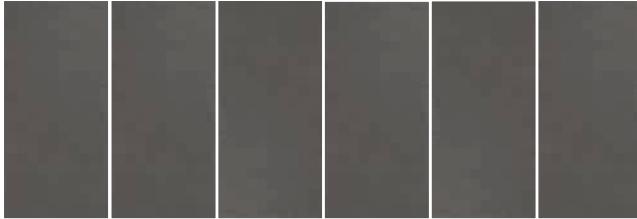

CARBON\_FLAKES

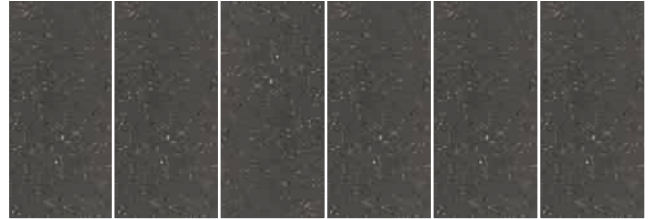

SAVANNAH\_GROUND

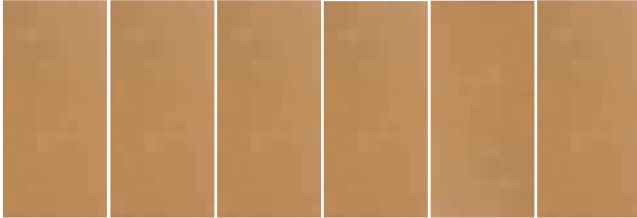

SAVANNAH\_FLAKES



OUTBACK\_GROUND

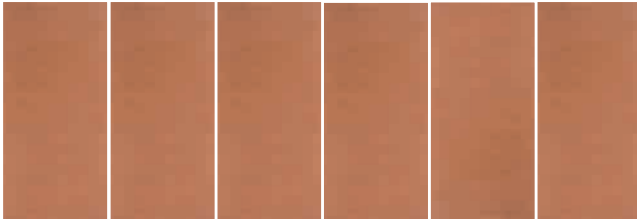

OUTBACK\_FLAKES

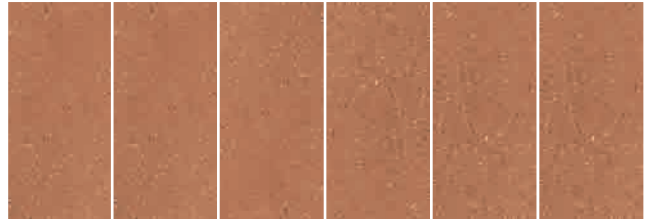

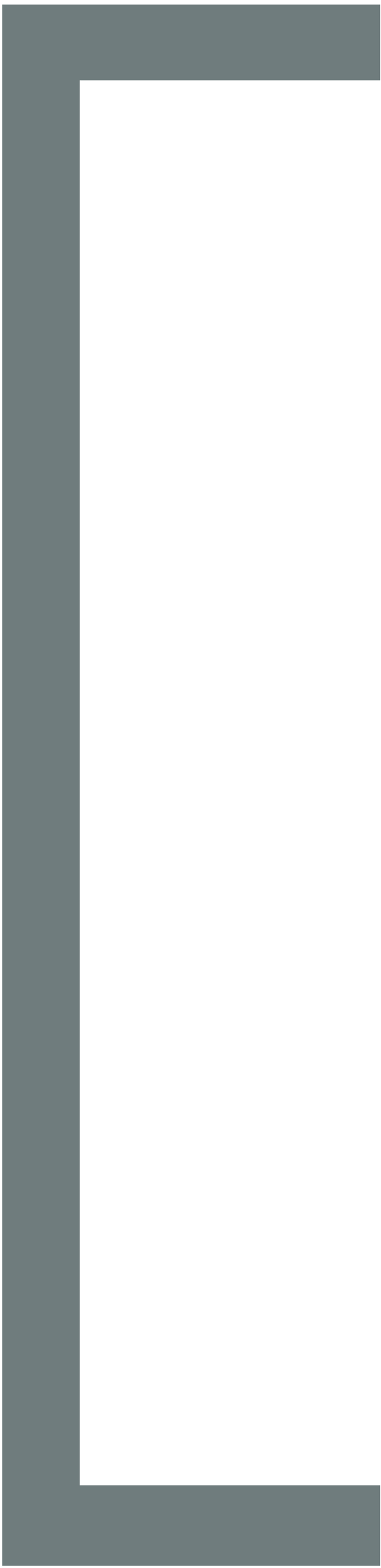

# CARATTERISTICHE TECNICHE

TECHNICAL FEATURES  
CARACTÉRISTIQUES TECHNIQUES  
TECHNISCHE EIGENSCHAFTEN  
CARACTERÍSTICAS TÉCNICAS

6mm



# BUILDTECH/2.0 - FLOWTECH

6 mm 1/4"

GRES FINE PORCELLANATO/FINE PORCELAIN STONEWARE/GRES CERAME FIN/FEINSTEINZEUG-KOLLEKTIONEN/GRES PORCELANICO FINO  
SQUADRATO - SQUARED - EQUARRI - REKTIFFIERT - ESCUADRADO

CARATTERISTICHE TECNICHE - TECHNICAL CHARACTERISTICS - CARACTERISTIQUES TECHNIQUES - TECHNISCHE EIGENSCHAFTEN - CARACTERÍSTICAS TÉCNICAS								
	Lastre in gres fine porcellanato non smaltato. Piastrelle di ceramica pressate a secco. Caratteristiche di qualità secondo i test di controllo previsti dalla norma EN 14411-ISO 13006 Appendice G gruppo Bia UGL. / Unglazed porcelain stoneware slabs. Dry-pressed ceramic tiles. Quality specifications, according to control tests of EN 14411-ISO 13006 Appendix G group Bia UGL. / Dalles en grés cérame fin non émaillé. Carreaux céramiques pressés à sec. Caractéristiques de qualité d'après les essais de contrôle norme EN 14411-ISO 13006 Appendice G groupe Bia UGL. / Nicht glasierte und vollständig gesinterte Feinsteinzeugplatten. Trocken gepresste Keramikfliesen. Qualitätseigenschaften nach Normen EN 14411-ISO 13006 Anhang G Gruppe Bia UGL. / Planchas de gres porcelánico fino no esmaltado. Baldosas de cerámica rensadas en seco. Características de calidad según las Normas EN 14411-ISO 13006 Apéndice G grupo Bia UGL.	PRESCRIZIONE STANDARD REQUIREMENTS PRESCRIPTIONS ANFORDERUNGEN PRESCRIPCION		RISULTATI TESTS TEST RESULTS RESULTATS DES ESSAIS PRÜFERGEBNIS RESULTADOS TESTS				RIFERIMENTO NORMA REFERENCE STANDARD RÉFÉRENCE NORME STANDARWERT REFERENCIA NORMA
		N ≥ 15 cm		BUILDTECH/2.0		FLOWTECH		
		(%)	(mm)	NATURALE MATTE	R+PTV	NATURALE MATTE	R+PTV	
	LUNGHEZZA E LARGHEZZA: DEVIAZIONE AMMISSIBILE, IN %, DELLA DIMENSIONE MEDIA DI OGNI PIASTRELLA DALLA DIM. DI FABBRICAZIONE / LENGTH AND WIDTH: ADMITTED DEVIATION, IN %, OF THE AVERAGE SIZE OF EACH TILE FROM THE PRODUCTION DIMENSIONS / LONGUEUR ET LARGEUR : MARGE DE TOLÉRANCE, EN %, ENTRE LA DIMENSION MOYENNE DE CHAQUE CARREAU ET LA DIM. DE FABRICATION / LANGE UND BREITE: ZULASSIGE ABWEICHUNG DES DURCHSCHNITTMÄßES JEDER FLESE VOM HERSTELLMAß IN PROZENTEN / LARGO Y ANCHO: DESVIACION ADMISIBLE, EN %, DEL TAMAÑO MEDIO DE CADA BALDOSA A PARTIR DEL TAMAÑO DE FABRICACION.	Squadrato ISO 13006	±0,3%	±1,0 mm			±0,15%	ISO 10545-2
	DEVIAZIONE AMMISSIBILE, IN PERCENTO, DELLO SPESSORE MEDIO DI OGNI PIASTRELLA DALLA DIMENSIONE DI FABBRICAZIONE / ADMITTED DEVIATION, IN %, OF THE AVERAGE THICKNESS OF EACH TILE FROM THE PRODUCTION DIMENSIONS / MARGE DE TOLÉRANCE, EN POURCENTAGE, ENTRE L'ÉPAISSEUR MOYENNE DE CHAQUE CARREAU ET LA DIMENSION DE FABRICATION / ZULASSIGE ABWEICHUNG DER DURCHSCHNITTSDICKE JEDER FLESE VOM HERSTELLMAß IN PROZENTEN / DESVIACION ADMISIBLE, EN TANTO POR CIENTO, DEL GROSOR MEDIO DE CADA BALDOSA A PARTIR DEL TAMAÑO DE FABRICACION.	Squadrato ISO 13006	±5%	±0,5 mm			±5%	ISO 10545-2
	DEVIAZIONE MASSIMA DI RETTILINEARITÀ, IN PERCENTO, IN RAPPORTO ALLE DIMENSIONI DI FABBRICAZIONE CORRISPONDENTI / MAXIMUM STRAIGHTNESS DEVIATION, IN %, IN RELATION TO THE CORRESPONDING PRODUCTION DIMENSIONS / MARGE DE TOLÉRANCE DE RECTITUDE, EN POURCENTAGE, PAR RAPPORT AUX DIMENSIONS DE FABRICATION CORRÉPONDANTES / ZULASSIGE HOCHSTABWEICHUNG DER KANTENGERADHEIT IM VERHÄLTNIS ZU DEN ENTSPRECHENDEN HERSTELLMAßEN IN PROZENTEN / DESVIACION MÁXIMA DE RECTITUD, EN TANTO POR CIENTO, EN RELACION CON EL TAMAÑO DE FABRICACION CORRESPONDIENTE.	Squadrato ISO 13006	±0,3%	±0,8 mm			±0,10%	ISO 10545-2
	DEVIAZIONE MASSIMA DI ORTOGONALITÀ, IN PERCENTO, IN RAPPORTO ALLE DIMENSIONI DI FABBRICAZIONE CORRISPONDENTI MAXIMUM RIGHT-ANGLE DEVIATION, IN %, IN RELATION TO THE CORRESPONDING PRODUCTION DIMENSIONS / MARGE DE TOLÉRANCE D'ANGULARITÉ, EN POURCENTAGE, PAR RAPPORT AUX DIMENSIONS DE FABRICATION / HOCHSTABWEICHUNG DER RECHTWINKELIGKEIT IM VERHÄLTNIS ZU DEN ENTSPRECHENDEN HERSTELLMAßEN IN PROZENTEN / DESVIACION MÁXIMA DE LA ORTOGONALIDAD, EN TANTO POR CIENTO, EN RELACION CON EL TAMAÑO DE FABRICACION CORRESPONDIENTE.	Squadrato ISO 13006	±0,3%	±1,5 mm			±0,20%	ISO 10545-2
	PLANARITÀ (CURVATURA DEL CENTRO, DELLO SPIGOLO E SVERGOLAMENTO) / FLATNESS (CURVING IN THE MIDDLE, CORNER AND WARPING) / PLANÉITÉ (COUBRE CURCENTRALE, DE L'ARÊTE ET GAUCHISSEMENT) / EBENFLACHIGKEIT (KRÜMMUNG DER MITTE, DER KANTE UND VERWINDUNG) / PLANITUD (CURVATURA DEL CENTRO, DE LA ARISTA Y ABARQUILLAMIENTO).	Squadrato ISO 13006	±0,4%	±1,8 mm			±0,20%	ISO 10545-2
	QUALITÀ DELLA SUPERFICIE / SURFACE QUALITY / QUALITÉ DE LA SURFACE / QUALITÄT DER OBERFLÄCHE / CALIDAD DE LA SUPERFICIE.	Il 95% min delle piastrelle deve essere esente da difetti visibili. / At least 95% of the tiles must be free from visible flaws. 95% min des carreaux ne doivent présenter aucun défaut visible. Mindestens 95% der Fliesen müssen frei von sichtbaren min. / el 95% de las baldosas tiene que estar exento de defectos visibles.					CONFORME/CONFORMING CONFORME/KONFORM CONFORME	ISO 10545-2
	MASSA D'ACQUA ASSORBITA IN % / % WATER ABSORPTION - MASSE D'EAU ABSORBÉE EN % / WASSERAUFNAHME IN % / MASA DE AGUA ABSORBIDA EN %		< 0,5%				valore medio 0,08%	ISO 10545-3
	FORZA DI ROTTURA IN N (sp. < 7,5 mm) - BREAKING STRENGTH IN N (thickness < 7,5 mm) / FORCE DE RUPTURE EN N (ép. < 7,5 mm) / BRUCHLAST IN N (Dicke < 7,5 mm) / FUERZA DE ROTURA EN N (gr. < 7,5 mm).			≥ 700 N			valore medio 1350 N	ISO 10545-4
	RESISTENZA ALLA FLESSIONE IN N/mm <sub>2</sub> / N/mm <sub>2</sub> FLEXURAL STRENGTH TEST / RESISTENCIA A LA FLEXION EN N/mm <sub>2</sub> / BIEGESTÄRKE IN N/mm <sub>2</sub> / RESISTENCIA A LA FLEXIÓN EN N/mm <sub>2</sub>			35 MIN. N/mm <sub>2</sub>			valore medio 52 N/mm <sub>2</sub>	ISO 10545-4
	RESISTENZA ALL'ABRASIONE PROFONDA DELLE PIASTRELLE NON SMALTATE / RESISTANCE TO DEEP ABRASION OF UNGLAZED TILES / RESISTANCE À L'ABRASION PROFONDE DES CARREAUX NON ÉMAILLÉS / TIEFENABRIEFESTIGKEIT UNGLASIERTER FLESEN / RESISTENCIA A LA ABRASION PROFUNDA DE LAS BALDOSAS SIN ESMALTAR.			< 175 mm <sup>3</sup>			valore medio 140 mm <sup>3</sup>	ISO 10545-6
	RESISTENZA AGLI SBALZI TERMICI / THERMAL SHOCKS RESISTANT / RESISTANCE AUX VARIATIONS THERMIQUES / TEMPERATURWECHSELBESTÄNDIGKEIT / RESISTENCIA AL CHOQUE TERMICO.	Metodo di prova disponibile / Available testing method Méthode d'essai disponible / Verfügbare Prüfmethode Método de ensayo disponible					RESISTE - RESISTANT RESISTE - ERFÜLLT RESISTE	ISO 10545-9
	RESISTENZA AL GELO / FROST RESISTANCE / RESISTANCE AU GEL / FROSTSICHERHEIT / RESISTENCIA A LA HELADA	RICHIESTA - REQUIRED REQUIRE - GEFORDERT REQUERIDA					RESISTE - RESISTANT RESISTE - ERFÜLLT RESISTE	ISO 10545-12
	RESISTENZA ALLE MACCHIE / RESISTANCE TO STAINING / RESISTANCE AUX TACHES / FLECKENABWEISEND / RESISTENCIA A LAS MANCHAS.	Metodo di prova disponibile / Available testing method Méthode d'essai disponible / Verfügbare Prüfmethode Método de ensayo disponible		Classe 4-5	Classe 4-5	Classe 4-5	Classe 4	ISO 10545-14
	RILASCIO DI SOSTANZE PERICOLOSE / RELEASE OF HAZARDOUS SUBSTANCES / REJET DE SUBSTANCES DANGEREUSES / FREISETZUNG GEFAHRLICHER STOFFE / LIBERACIÓN DE SUSTANCIAS PELIGROSAS / CADMIO (in mg/dm <sup>2</sup> ) - PIOMBO (in mg/dm <sup>2</sup> )	VALORE DICHIARATO PER SUPERFICIE GL CON IMPEGHI SU PAVI DI LAVORO / DECLARED VALUE FOR GL SURFACES USED ON WORKTOPS / VALEUR DÉCLARÉE POUR SURFACES GL UTILISÉES SUR PAVI DE TRAVAIL / ANGEBOBENEN WERT FÜR GL OBERFLÄCHEN ZUM GEBRAUCH ALS ARBEITSPLATZEN / VALOR DECLARADO PARA ACABADOS GL UTILIZADOS PARA SUPERFICIES DE TRABAJO					CONFORME/CONFORMING CONFORME/KONFORM CONFORME	DM-1-2-2007-Reg-CE-1935-2004
	RESISTENZA A BASSE CONCENTRAZIONI DI ACIDI E ALCALI / RESISTANCE TO LOW CONCENTRATIONS OF ACIDS AND ALKALIS / RESISTANCE A BASSES CONCENTRATIONS D'ACIDES ET ALCALIS / WIDERSTAND GEGEN NIEDRIGE KONZENTRATIONEN VON SAUREN UND LAUGEN. / RESISTENCIA A BAJAS CONCENTRACIONES DE ACIDOS Y ALCALIS.	COME DICHIARATO DAL PRODUTTORE SEE MANUFACTURER'S DECLARATION SELON DECLARATION DU PRODUCTEUR ENTSPRECHEND DER HERSTELLERANGABEN TAL COMO DECLARA EL FABRICANTE		LA	LA-LB	LA-LB	LA-LB	ISO 10545-13
	RESISTENZA AI PRODOTTI CHIMICI DI USO DOMESTICO E AGLI ADDITIVI PER PISCINA / RESISTENCE TO DOMESTIC CHEMICAL PRODUCTS AND ADDITIVES FOR SWIMMING POOLS / RESISTANT AUX PRODUITS CHIMIQUES A USAGE DOMESTIQUE ET AUX ADDITIFS POUR PISCINE / WIDERSTAND GEGEN HAUSHALTSCHIMIKALIEN UND / SCHWIMMBADZUSATZSTOFFEN / RESISTENCIA A PRODUCTOS PARA LIMPIEZA DOMESTICA Y ADITIVOS PARA PISCINAS			MIN B			A	
				6° < α ≤ 10° R9	10° < α ≤ 19° R10	6° < α ≤ 10° R9	10° < α ≤ 19° R10	DIN EN 16165 ANNEX B
	COEFFICIENTE D'ATTRITO (SCIOLOSITÀ) / FRICTION COEFFICIENT (SLIPPERINESS) / COEFFICIENT DE FRICTION (GLISSEMENT) / REIBUNGSKOEFFIZIENT (SCHLUPFRIGKEIT) / COEFFICIENTE DE ANTI DESLIZAMIENTO.			12° ≤ α < 18° classe A	18° ≤ α < 24° classe B	-	18° ≤ α < 24° classe B	DIN EN 16165 ANNEX A
						> 0,42 wet		DCOF ANSI A 326.3
						PTV >36 wet slider 96	PTV >36 wet 96	BS EN 16165 ANNEX C

Per un effetto ottimale della posa, florim suggerisce di mantenere 2 mm di fuga per pose monoformato e 3 mm per combinare formati misti / For optimal installation results, florim recommends maintaining a joint of 2 mm 1/12" for single format installations and 3 mm 1/8" to combine mixed formats / Pour réatter les meilleurs résultats de la pose du produit, florim conseille 2 mm de joint pour les combinaisons de formats mixtes / Um einen optimalen effekt beim verlegen zu erzielen empfehlt florim eine 2 mm fugel bei einformatigen verlegungen und 3 mm fugel bei formatkombinationen / Para lograr los máximos resultados en la posa del producto, florim aconseja 2 mm de junta en aplicaciones monoformato y 3 mm en combinaciones de formatos mixtos.

# B&W\_MARBLE - STONTECH/4.0

GRES FINE PORCELLANATO/FINE PORCELAIN STONEWARE/GRES CERAME FIN/FEINSTEINZEUG-KOLLEKTIONEN/GRES PORCELANICO FINO  
SQUADRATO - SQUARED - EQUARRI - REKTIFIZIERT - ESCUADRADO

6 mm 1/4" 

CARATTERISTICHE TECNICHE - TECHNICAL CHARACTERISTICS - CARACTERISTIQUES TECHNIQUES - TECHNISCHE EIGENSCHAFTEN - CARACTERÍSTICAS TÉCNICAS		PRESCRIZIONE STANDARD REQUIREMENTS PRESCRIPTIONS ANFORDERUNGEN PRESCRIPCION		RISULTATI TESTS TEST RESULTS RESULTATS DES ESSAIS PRÜFERGEBNIS RESULTADOS TESTS					RIFERIMENTO NORMA REFERENCE STANDARD RÉFÉRENCE NORME STANDARDEWERT REFERENCIA NORMA
		N ≥ 15 cm		B&W_MARBLE		STONTECH/4.0			
		(%)	(mm)	NATURALE	HIGH GLOSSY	NATURALE MATTE	HIGH GLOSSY	R+PTV	
Lastre in gres fine porcellanato non smaltato. Piastrelle di ceramica pressate a secco. Caratteristiche di qualità secondo i test di controllo previsti dalla norma EN 14411-ISO 13006 Appendice G gruppo Bia UGL. / Unglazed porcelain stoneware slabs. Dry-pressed ceramic tiles. Quality specifications, according to control tests of EN 14411-ISO 13006 Appendix G group Bia UGL. / Dalles en grés cérame fin non émaillé. Carreaux céramiques pressés à sec. Caractéristiques de qualité d'après les essais de contrôle norme EN 14411-ISO 13006 Appendice G groupe Bia UGL. / Nicht glasierte und vollständig gesinterte Feinsteinzeugplatten. Trocken gepresste Keramikfliesen. Qualitätseigenschaften nach Normen EN 14411-ISO 13006 Anhang G Gruppe Bia UGL. / Planchas de gres porcelánico fino no esmaltado. Baldosas de cerámica resandadas en seco. Características de calidad según las Normas EN 14411-ISO 13006 Apéndice G grupo Bia UGL.		Squadrato ISO 13006	±0,3%	±1,0mm			±0,15%		ISO 10545-2
LUNGHEZZA E LARGHEZZA: DEVIAZIONE AMMISSIBILE, IN %, DELLA DIMENSIONE MEDIA DI OGNI PIASTRELLA DALLA DIM. DI FABBRICAZIONE / LENGTH AND WIDTH: ADMITTED DEVIATION, IN %, OF THE AVERAGE SIZE OF EACH TILE FROM THE PRODUCTION DIMENSIONS / LONGUEUR ET LARGEUR - MARGE DE TOLÉRANCE, EN %, ENTRE LA DIMENSION MOYENNE DE CHAQUE CARREAU ET LA DIM. DE FABRICATION / LÄNGE UND BREITE: ZULÄSSIGE ABWEICHUNG DES DURCHSCHNITTMASSES JEDER FLIESE VOM HERSTELLMAß IN PROZENTEN / LARGO Y ANCHO: DESVIACION ADMISIBLE, EN %, DEL TAMAÑO MEDIO DE CADA BALDOSA A PARTIR DEL TAMAÑO DE FABRICACIÓN.		-	±5%	±0,5mm			±5%		ISO 10545-2
DEVIAZIONE AMMISSIBILE, IN PERCENTO, DELLO SPESSORE MEDIO DI OGNI PIASTRELLA DALLA DIMENSIONE DI FABBRICAZIONE / ADMITTED DEVIATION, IN %, OF THE AVERAGE THICKNESS OF EACH TILE FROM THE PRODUCTION DIMENSIONS / MARGE DE TOLÉRANCE, EN POURCENTAGE, ENTRE L'ÉPAISSEUR MOYENNE DE CHAQUE CARREAU ET LA DIMENSION DE FABRICATION / ZULÄSSIGE ABWEICHUNG DER DURCHSCHNITTSDICKE JEDER FLIESE VOM HERSTELLMAß IN PROZENTEN / DESVIACION ADMISIBLE, EN TANTO POR CIENTO, DEL GROSOR MEDIO DE CADA BALDOSA A PARTIR DEL TAMAÑO DE FABRICACIÓN.		Squadrato ISO 13006	±0,3%	±0,8mm			±0,10%		ISO 10545-2
DEVIAZIONE MASSIMA DI RETTILINEARITÀ IN PERCENTO, IN RAPPORTO ALLE DIMENSIONI DI FABBRICAZIONE CORRISPONDENTI / MAXIMUM STRAIGHTNESS DEVIATION, IN %, IN RELATION TO THE CORRESPONDING PRODUCTION DIMENSIONS / MARGE DE TOLÉRANCE DE RECTITUDE, EN POURCENTAGE, PAR RAPPORT AUX DIMENSIONS DE FABRICATION CORRÉPONDANTES / ZULÄSSIGE HOCHSTABWEICHUNG DER KANTENGERADHEIT IM VERHÄLTNIS ZU DEN ENTSPRECHENDEN HERSTELLMAßEN IN PROZENTEN / DESVIACION MÁXIMA DE RECTITUD, EN TANTO POR CIENTO, EN RELACION CON EL TAMAÑO DE FABRICACIÓN CORRESPONDIENTE.		Squadrato ISO 13006	±0,3%	±1,5mm			±0,20%		ISO 10545-2
DEVIAZIONE MASSIMA DI ORTOGONALITÀ IN PERCENTO, IN RAPPORTO ALLE DIMENSIONI DI FABBRICAZIONE CORRISPONDENTI / MAXIMUM RIGHT-ANGLE DEVIATION, IN %, IN RELATION TO THE CORRESPONDING PRODUCTION DIMENSIONS / MARGE DE TOLÉRANCE D'ANGULARITÉ, EN POURCENTAGE, PAR RAPPORT AUX DIMENSIONS DE FABRICATION / HOCHSTABWEICHUNG DER RECHTWINKLIGKEIT IM VERHÄLTNIS ZU DEN ENTSPRECHENDEN HERSTELLMAßEN IN PROZENTEN / DESVIACION MÁXIMA DE LA ORTOGONALIDAD, EN TANTO POR CIENTO, EN RELACION CON EL TAMAÑO DE FABRICACIÓN CORRESPONDIENTE.		Squadrato ISO 13006	±0,4%	±1,8mm			±0,20%		ISO 10545-2
PLANARITÀ (CURVATURA DEL CENTRO DELLO SPIGOLO E SVERGOLAMENTO) / FLATNESS (CURVING IN THE MIDDLE CORNER AND WARPING) / PLANEITÉ (COUBURE CENTRALE, DE L'ARÊTE ET GAUCHISSEMENT) / EBENFLÄCHIGKEIT (KRÜMMUNG, DER MITTE, DER KANTE UND VERWINDUNG) / PLANITUD (CURVATURA DEL CENTRO, DE LA ARISTÁ Y ABARQUILLAMIENTO).		Squadrato ISO 13006							ISO 10545-2
QUALITÀ DELLA SUPERFICIE / SURFACE QUALITY / QUALITÉ DE LA SURFACE / QUALITÄT DER OBERFLÄCHE / CALIDAD DE LA SUPERFICIE.		Il 95% min delle piastrelle deve essere esente da difetti visibili. / At least 95% of the tiles must be free from visible flaws. 95% min des carreaux ne doivent présenter aucun défaut visible. Mindestens 95% der Fliesen müssen frei von sichtbaren Mängeln. / el 95% de las baldosas tiene que estar exento de defectos visibles.				CONFORME/CONFORMING CONFORME/KONFORM CONFORME			ISO 10545-2
MASSA D'ACQUA ASSORBITA IN % / % WATER ABSORPTION - MASSE D'EAU ABSORBÉE EN % / WASSERAUFNAHME IN % / MASA DE AGUA ABSORBIDA EN %		< 0,5%				valore medio 0,08%			ISO 10545-3
FORZA DI ROTTURA IN N (sp. < 7,5 mm) - BREAKING STRENGTH IN N (thickness < 7,5 mm) / FORCE DE RUPTURE EN N (ép. < 7,5 mm) / BRUCHLAST IN N (Dicke < 7,5 mm) / FUERZA DE ROTURA EN N (gr. < 7,5 mm)		≥ 700 N				valore medio 1350 Newton			ISO 10545-4
RESISTENZA ALLA FLESSIONE IN N/mm <sub>2</sub> / N/mm <sub>2</sub> FLEXURAL STRENGTH TEST / RESISTENCIA A LA FLEXION EN N/mm <sub>2</sub> / BIEGESTÄRKE IN N/mm <sub>2</sub> / RESISTENCIA A LA FLEXION EN N/mm <sub>2</sub>		35 MIN. N/mm <sub>2</sub>				valore medio 52 N/mm <sub>2</sub>			ISO 10545-4
RESISTENZA ALL'ABRASIONE PROFONDA DELLE PIASTRELLE NON SMALTATE / RESISTANCE TO DEEP ABRASION OF UNGLAZED TILES / RESISTANCE A L'ABRASION PROFONDE DES CARREAUX NON ÉMAILLÉS / TIEFENABRIEFESTIGKEIT UNGLASIRTER FLIESEN / RESISTENCIA A LA ABRASION PROFUNDA DE LAS BALDOSAS SIN ESMALTAR.		< 175 mm <sup>3</sup>				valore medio 140 mm <sup>3</sup>			ISO 10545-6
RESISTENZA AGLI SBALZI TERMICI / THERMAL SHOCKS RESISTANT / RESISTANCE AUX VARIATIONS THERMIQUES / TEMPERATURWECHSELBESTÄNDIGKEIT / RESISTENCIA AL CHOQUE TERMICO.		Metodo di prova disponibile Available testing method Méthode d'essai disponible Verfügbare Prüfmethode Método de ensayo disponible				RESISTE - RÉSISTANT RESISTE - ERFÜLLT RESISTE			ISO 10545-9
RESISTENZA AL GELO / FROST RESISTANCE / RESISTANCE AU GEL / FROSTSICHERHEIT / RESISTENCIA A LA HELADA		Metodo di prova disponibile Available testing method Méthode d'essai disponible Verfügbare Prüfmethode Método de ensayo disponible				RICHIESTA - REQUIRED REQUIRE - GEFORDERT REQUERIDA			ISO 10545-12
RESISTENZA ALLE MACCHIE / RESISTANCE TO STAINING / RESISTANCE AUX TACHES / FLECKENABWEISEND / RESISTENCIA A LAS MANCHAS.		Metodo di prova disponibile Available testing method Méthode d'essai disponible Verfügbare Prüfmethode Método de ensayo disponible		Classe 5	Classe 4	Classe 4	Classe 4	Classe 4-5	ISO 10545-14
RILASCIO DI SOSTANZE PERICOLOSE / RELEASE OF HAZARDOUS SUBSTANCES / REJET DE SUBSTANCES DANGEREUSES / FREISETZUNG GEFAHRLICHER STOFFE / LIBERACION DE SUSTANCIAS PELIGROSAS / CADMIO (in mg/dm <sup>2</sup> ) - PIOMBO (in mg/dm <sup>2</sup> )		VALORE DICHIARATO PER SUPERFICEL CON IMPIEGHI SU PAVI DI LAVORO / DECLARÉ VALUE FOR GL SURFACES USED ON WORKTOPS / VALEUR DÉCLARÉE POUR SURFACES GL UTILISÉES SUR PLANS DE TRAVAIL / ANGEZEIGENER WERT FÜR GL-OBERFLÄCHEN ZUM GEBRAUCH ALS ARBEITSPLATZEN / VALOR DECLARADO PARA ACABADOS GL UTILIZADOS PARA SUPERFICIES DE TRABAJO				CONFORME/CONFORMING CONFORME/KONFORM CONFORME			DM-1-2-2007-Reg-CE-1935-2004
RESISTENZA A BASSE CONCENTRAZIONI DI ACIDI E ALCALI / RESISTANCE TO LOW CONCENTRATIONS OF ACIDS AND ALKALIS / RESISTANCE A BASSES CONCENTRATIONS D'ACIDES ET ALCALIS / WIDERSTAND GEGEN NIEDRIGE KONZENTRATIONEN VON SAUREN UND LAUGEN. / RESISTENCIA A BAJAS CONCENTRACIONES DE ACIDOS Y ALCALIS.		COME DICHIARATO DAL PRODUTTORE SEE MANUFACTURER'S DECLARATION SELON DECLARATION DU PRODUCTEUR ENTSPRECHEND DER HERSTELLERANGABEN TAL COMO DECLARA EL FABRICANTE		LA-LB	LB	LA-LB	LB	LA-LB	ISO 10545-13
RESISTENZA AI PRODOTTI CHIMICI DI USO DOMESTICO E AGLI ADDITIVI PER PISCINA / RESISTANCE TO DOMESTIC CHEMICAL PRODUCTS AND ADDITIVES FOR SWIMMING POOLS / RÉSISTANT AUX PRODUITS CHIMIQUES A USAGE DOMESTIQUE ET AUX ADDITIFS POUR PISCINE / WIDERSTAND GEGEN HAUSHALTSCHIMIKALIEN UND / SCHWIMMIBADZUSATZSTOFFEN / RESISTENCIA A PRODUCTOS PARA LIMPIEZA DOMESTICA Y ADITIVOS PARA PISCINAS		MIN B				A			
COEFFICIENTE D'ATTRITO (SCIVOLOSITÀ) / FRICTION COEFFICIENT (SLIPPERINESS) / COEFFICIENT DE FRICTION (GLISSEMENT) / REIBUNGSKOEFFIZIENT (SCHLUPFRIGKEIT) / COEFFICIENTE DE ANTI DESLIZAMIENTO.				6° < α ≤ 10° R9	-	6° < α ≤ 10° R9	-	10° < α ≤ 19° R10	DIN EN 16165 ANNEX B
				-	-	-	-	18° ≤ α < 24° classe B	DIN EN 16165 ANNEX A
				-	-	-	-	PTV>36 wet slider 96	BS EN 16165 ANNEX C
				> 0,42 wet	-	> 0,42 wet	-	> 0,42 wet	ANSI A 326.3

Per un effetto ottimale della posa, florim suggerisce di mantenere 2 mm di fuga per pose monofornate e 3 mm per combinare formati misti / For optimal installation results, florim recommends maintaining a joint of 2 mm 1/12" for single format installations and 3 mm 1/8" to combine mixed formats / Pour réaliser une pose parfaite, florim suggère de maintenir 2 mm de joint pour la pose des monofornats, et 3 mm pour les combinaisons de formats mixtes / Um einen optimalen effekt beim verlegen zu erzielen empfehlt florim eine 2 mm fugel bei einformatigen verlegungen und 3 mm fugel bei formatkombinationen / Para lograr los máximos resultados en la posa del producto, florim aconseja 2 mm de junta en aplicaciones monofornato y 3 mm en combinaciones de formatos mixtos.

# INDUSTRIAL - RAWTECH











GRES FINE PORCELLANATO/FINE PORCELAIN STONWARE/GRES CERAME FIN/FEINSTEINZEUG-KOLLEKTIONEN/GRES PORCELANICO FINO  
SQUADRATO - SQUARED - EQUARRI - REKTIFIZIERT - ESCUADRADO

6 mm 1/4"



CARATTERISTICHE TECNICHE - TECHNICAL CHARACTERISTICS - CARACTERISTIQUES TECHNIQUES - TECHNISCHE EIGENSCHAFTEN - CARACTERÍSTICAS TÉCNICAS		PRESCRIZIONE STANDARD REQUIREMENTS PRESCRIPTIONS ANFORDERUNGEN PRESCRIPCION		RISULTATI TESTS TEST RESULTS RESULTATS DES ESSAIS PRÜFERGEBNIS RESULTADOS TESTS			RIFERIMENTO NORMA REFERENCE STANDARD RÉFÉRENCE NORME STANDARDWERT REFERENCIA NORMA
		N ≥ 15 cm		INDUSTRIAL		RAWTECH	
		(%)	(mm)	NATURALE MATTE	R+PTV		
	LUNGHEZZA E LARGHEZZA: DEVIAZIONE AMMISSIBILE, IN %, DELLA DIMENSIONE MEDIA DI OGNI PIASTRELLA DALLA DIM. DI FABBRICAZIONE / LENGTH AND WIDTH: ADMITTED DEVIATION, IN %, OF THE AVERAGE SIZE OF EACH TILE FROM THE PRODUCTION DIMENSIONS / LONGUEUR ET LARGEUR: MARGE DE TOLÉRANCE, EN %, ENTRE LA DIMENSION MOYENNE DE CHAQUE CARREAU ET LA DIM. DE FABRICATION / LANGE UND BREITE: ZULASSIGE ABWEICHUNG DES DURCHSCHNITTMABES JEDER FLIESE VOM HERSTELLMAS IN PROZENTEN / LARGO Y ANCHO: DESVIACIÓN ADMISIBLE, EN %, DEL TAMAÑO MEDIO DE CADA BALDOSA A PARTIR DEL TAMAÑO DE FABRICACION.	Squadrato ISO 13006	±0,3%	±1,0mm	±0,15%		ISO 10545-2
	DEVIAZIONE AMMISSIBILE, IN PERCENTO, DELLO SPESSORE MEDIO DI OGNI PIASTRELLA DALLA DIMENSIONE DI FABBRICAZIONE / ADMITTED DEVIATION, IN %, OF THE AVERAGE THICKNESS OF EACH TILE FROM THE PRODUCTION DIMENSIONS / MARGE DE TOLÉRANCE, EN POURCENTAGE, ENTRE L'ÉPAISSEUR MOYENNE DE CHAQUE CARREAU ET LA DIMENSION DE FABRICATION / ZULASSIGE ABWEICHUNG DER DURCHSCHNITTSDICKE JEDER FLIESE VOM HERSTELLMAS IN PROZENTEN / DESVIACIÓN ADMISIBLE, EN TANTO POR CIENTO, DEL GROSOR MEDIO DE CADA BALDOSA A PARTIR DEL TAMAÑO DE FABRICACION.	Squadrato ISO 13006	±5%	±0,5mm	±5%		ISO 10545-2
	DEVIAZIONE MASSIMA DI RETTILINEARITÀ, IN PERCENTO, IN RAPPORTO ALLE DIMENSIONI DI FABBRICAZIONE / MAXIMUM STRAIGHTNESS DEVIATION, IN %, IN RELATION TO THE CORRESPONDING PRODUCTION DIMENSIONS / MARGE DE TOLÉRANCE DE RECTITUDE, EN POURCENTAGE, PAR RAPPORT AUX DIMENSIONS DE FABRICATION CORRESPONDANTES / ZULASSIGE HÖCHSTABWEICHUNG DER KANTENGERADHEIT IM VERHÄLTNIS ZU DEN ENTSPRECHENDEN HERSTELLMÄSSEN IN PROZENTEN / DESVIACIÓN MÁXIMA DE RECTITUD, EN TANTO POR CIENTO, EN RELACIÓN CON EL TAMAÑO DE FABRICACION CORRESPONDIENTE.	Squadrato ISO 13006	±0,3%	±0,8mm	±0,10%		ISO 10545-2
	DEVIAZIONE MASSIMA DI ORTOGONALITÀ, IN PERCENTO, IN RAPPORTO ALLE DIMENSIONI DI FABBRICAZIONE CORRISPONDENTI MAXIMUM RIGHT-ANGLE DEVIATION, IN %, IN RELATION TO THE CORRESPONDING PRODUCTION DIMENSIONS / MARGE DE TOLÉRANCE D'ANGULARITÉ, EN POURCENTAGE, PAR RAPPORT AUX DIMENSIONS DE FABRICATION / HÖCHSTABWEICHUNG DER RECHTWINKLIGKEIT IM VERHÄLTNIS ZU DEN ENTSPRECHENDEN HERSTELLMÄSSEN / DESVIACIÓN MÁXIMA DE LA ORTOGONALIDAD, EN TANTO POR CIENTO, EN RELACIÓN CON EL TAMAÑO DE FABRICACION CORRESPONDIENTE.	Squadrato ISO 13006	±0,3%	±1,5mm	±0,20%		ISO 10545-2
	PLANARITÀ (CURVATURA DEL CENTRO, DELLO SPIGOLO E SVERGOLAMENTO) / FLATNESS (CURVING IN THE MIDDLE, CORNER AND WARPING) / PLANÉITÉ (COURBURE CENTRALE, DE L'ARÊTE ET GAUCHISSEMENT) / EBENFLÄCHIGKEIT (KRÜMMUNG DER MITTE, DER KANTE UND VERWINDUNG) / PLANITUD (CURVATURA DEL CENTRO, DE LA ARISTA Y ABARQUILLAMIENTO).	Squadrato ISO 13006	±0,4%	±1,8mm	±0,20%		ISO 10545-2
QUALITÀ DELLA SUPERFICIE / SURFACE QUALITY / QUALITÉ DE LA SURFACE / QUALITÄT DER OBERFLÄCHE / CALIDAD DE LA SUPERFICIE.	Il 95% min delle piastrelle deve essere esente da difetti visibili. / At least 95% of the tiles must be free from visible flaws. / 95% min des carreaux ne doivent présenter aucun défaut visible. Mindestens 95% der Fliesen müssen frei von sichtbaren min. / el 95% de las baldosas tiene que estar exento de defectos visibles.			CONFORME/CONFORMING CONFORME/KONFORM CONFORME		ISO 10545-2	
MASSA D'ACQUA ASSORBITA IN % / % WATER ABSORPTION - MASSE D'EAU ABSORBÉE EN % / WASSERAUFNAHME IN % / MASA DE AGUA ABSORBIDA EN %	< 0,5%			valore medio 0,08%		ISO 10545-3	
FORZA DI ROTTURA IN N (sp. < 7,5 mm) - BREAKING STRENGTH IN N (thickness < 7,5 mm) / FORCE DE RUPTURE EN N (ép. < 7,5 mm) / BRUCHLAST IN N (Dicke < 7,5 mm) / FUERZA DE ROTURA EN N (gr. < 7,5 mm).	≥ 700 N			valore medio 1350 N		ISO 10545-4	
RESISTENZA ALLA FLESSIONE IN N/mm <sub>2</sub> / N/mm <sub>2</sub> , FLEXURAL STRENGTH TEST / RESISTENCIA A LA FLEXION EN N/mm <sub>2</sub> / BIEGESTÄRKE IN N/mm <sub>2</sub> / RESISTENCIA A LA FLEXION EN N/mm <sub>2</sub>	35 MIN. N/mm <sub>2</sub>			valore medio 52 N/mm <sub>2</sub>		ISO 10545-4	
RESISTENZA ALL'ABRASIONE PROFONDA DELLE PIASTRELLE NON SMALTATE / RESISTANCE TO DEEP ABRASION OF UNGLAZED TILES / RESISTANCE A L'ABRASION PROFONDE DES CARREAUX NON ÉMALLÉS / TIEFENABRIEFESTIGKEIT UNGLASIRTER FLIESEN / RESISTENCIA A LA ABRASION PROFUNDA DE LAS BALDOSAS SIN ESMALTAR.	< 175 mm <sup>3</sup>			valore medio 140 mm <sup>3</sup>		ISO 10545-6	
RESISTENZA AGLI SBALZI TERMICI / THERMAL SHOCKS RESISTANT / RÉSISTANCE AUX VARIATIONS THERMIQUES / TEMPERATURWECHSELBESTÄNDIGKEIT / RESISTENCIA AL CHOQUE TÉRMICO.	Metodo di prova disponibile / Available testing method Méthode d'essai disponible / Verfügbare Prüfmethode Método de ensayo disponible			RESISTE - RÉSISTANT RESISTE - ERFÜLLT RESISTE		ISO 10545-9	
RESISTENZA AL GELO / FROST RESISTANCE / RÉSISTANCE AU GEL / FROSTSICHERHEIT RESISTENCIA A LA HELADA	RICHIESTA - REQUIRED REQUIRE - GEFORDERT REQUERIDA			RESISTE - RÉSISTANT RESISTE - ERFÜLLT RESISTE		ISO 10545-12	
RESISTENZA ALLE MACCHIE / RESISTANCE TO STAINING / RÉSISTANCE AUX TACHES / FLECKENABWEISEND / RESISTENCIA A LAS MANCHAS.	Metodo di prova disponibile / Available testing method Méthode d'essai disponible / Verfügbare Prüfmethode Método de ensayo disponible			Classe 4	Classe 4	Classe 4	ISO 10545-14
RILASCIO DI SOSTANZE PERICOLOSE / RELEASE OF HAZARDOUS SUBSTANCES / REJET DE SUBSTANCES DANGEREUSES / FREISETZUNG GEFAHRLICHER STOFFE / LIBERACION DE SUSTANCIAS PELIGROSAS / CADMIO (in mg/dm <sup>2</sup> ) - PIOMBO (in mg/dm <sup>2</sup> )	VALORE DICHIARATO PER SUPERFICIE GL CON IMPREGHI SU PIANI DI LAVORO / DECLARED VALUE FOR GL SURFACES USED ON WORKTOPS / VALEUR DÉCLARÉE POUR SURFACES GL UTILISÉES SUR PLANS DE TRAVAIL / ANGEZEIGENER WERT FÜR GL OBERFLÄCHEN ZUM GEBRAUCH ALS ARBEITSPLATTEN / VALOR DECLARADO PARA ACABADOS GL UTILIZADOS PARA SUPERFICIES DE TRABAJO			CONFORME/CONFORMING CONFORME/KONFORM CONFORME		DM-1-2-2007-Reg-CE-1935-2004	
RESISTENZA A BASSE CONCENTRAZIONI DI ACIDI E ALCALI / RESISTANCE TO LOW CONCENTRATIONS OF ACIDS AND ALKALIS / RESISTANCE A BASSES CONCENTRATIONS D'ACIDES ET ALCALIS / WIDERSTAND GEGEN NIEDRIGE KONZENTRATIONEN VON SAUREN UND LAUGEN. / RESISTENCIA A BAJAS CONCENTRACIONES DE ACIDOS Y ALCALIS.	COME DICHIARATO DAL PRODUTTORE SEE MANUFACTURER'S DECLARATION SELON DECLARATION DU PRODUCTEUR ENTSPRECHEND DER HERSTELLERANGABEN TAL COMO DECLARA EL FABRICANTE			LA		ISO 10545-13	
RESISTENZA A ALTE CONCENTRAZIONI DI ACIDI ED ALCALI / RESISTANCE TO HIGH CONCENTRATIONS OF ACIDS AND ALKALIS / RESISTANCE A HAUTES CONCENTRATIONS D'ACIDES ET BASES / BESTÄNDIGKEIT GEGEN STARK KONZENTRIERTE SAURENUND LAUGEN / RESISTENCIA A ALTAS CONCENTRACIONES DE ACIDOS Y ALCALIS.				HA			
RESISTENZA AI PRODOTTI CHIMICI DI USO DOMESTICO E AGLI ADDITIVI PER PISCINA / RESISTENCE TO DOMESTIC CHEMICAL PRODUCTS AND ADDITIVES FOR SWIMMING POOLS / RESISTANT AUX PRODUITS CHIMIQUES À USAGE DOMESTIQUE ET AUX ADDITIFS POUR PISCINE / WIDERSTAND GEGEN HAUSHALTSCHEMIKALIEN UND / SCHWIMMBADZUSATZSTOFFEN / RESISTENCIA A PRODUCTOS PARA LIMPIEZA DOMESTICA Y ADITIVOS PARA PISCINAS	MIN B			A			
COEFFICIENTE D'ATTRITO (SCIVOLosità) / FRICTION COEFFICIENT (SLIPPERINESS) / COEFFICIENT DE FRICTION (GLISSEMENT) / REIBUNGSKOEFFIZIENT (SCHLUPFRIGKEIT) / COEFICIENTE DE ANTI DESLIZAMIENTO.	-			> 0,42 wet		ANSI A 326.3	
	-			18° ≤ α < 24° classe B	12° ≤ α < 18° classe A	DIN EN 16165 ANNEX A	
	-			6° < α ≤ 10° R9	6° < α ≤ 10° R9	DIN EN 16165 ANNEX B	
	-			PTV > 36 wet slider 96	-	BS EN 16165 ANNEX C	

Per un effetto ottimale della posa, florim suggerisce di mantenere 2 mm di fuga per pose monoformato e 3 mm per combinare formati misti / For optimal installation results, florim recommends maintaining a joint of 2 mm 1/16" for single format installations and 3 mm 1/8" to combine mixed formats / Pour réaliser une pose parfaite, florim suggère de maintenir 2 mm de joint pour la pose des monoformats, et 3 mm pour les combinaisons de formats mixtes / Um einen optimalen effekt beim verlegen zu erzielen empfiehlt florim eine 2 mm fugje bei einformatigen verlegungen und 3 mm fugje bei formatkombinationen / Para lograr los máximos resultados en la posa del producto, florim aconseja 2 mm de junta en aplicaciones monoformato y 3 mm en combinaciones de formatos mixtos.

CARATTERISTICHE TECNICHE - TECHNICAL CHARACTERISTICS - CARACTERISTIQUES TECHNIQUES - TECHNISCHE EIGENSCHAFTEN - CARACTERÍSTICAS TÉCNICAS						
	PRESCRIZIONE STANDARD REQUIREMENTS PRESCRIPTIONS ANFORDERUNGEN PRESCRIPCION	RISULTATI TESTS TEST RESULTS RESULTATS DES ESSAIS PRÜFERGEBNIS RESULTADOS TESTS		RIFERIMENTO NORMA REFERENCE STANDARD RÉFÉRENCE NORME STANDARWERT REFERENCIA NORMA		
		N ≥ 15 cm				
Lastre in gres fine porcellanato non smaltato. Piastrelle di ceramica pressate a secco. Caratteristiche di qualità secondo i test di controllo previsti dalla norma EN 14411-ISO 13006 Appendice G gruppo Bia UGL/ Unglazed porcelain stoneware slabs. Dry-pressed ceramic tiles. Quality specifications, according to control tests of EN 14411-ISO 13006 Appendix G group Bia UGL. / Dalles en gres cérame fin non émaillé. Carreaux céramiques pressés à sec. Caractéristiques de qualité d'après les essais de contrôle norme EN 14411-ISO 13006 Appendice G groupe Bia UGL/ Nicht glasierte und vollständig gesinterte Feinsteinzeugplatten. Trocken gepresste Keramikfliesen. Qualitätseigenschaften nach Normen EN 14411-ISO 13006 Anhang G Gruppe Bia UGL/ Planchas de gres porcelánico fino no esmaltado. Baldosas de cerámica rensadas en seco. Características de calidad según las Normas EN 14411-ISO 13006 Apéndice G grupo B1a UGL.		(%)	(mm)	COMFORT		
	LUNGHEZZA E LARGHEZZA: DEVIAZIONE AMMISSIBILE, IN %, DELLA DIMENSIONE MEDIA DI OGNI PIASTRELLA DALLA DIM. DI FABBRICAZIONE / LENGTH AND WIDTH: ADMITTED DEVIATION, IN %, OF THE AVERAGE SIZE OF EACH TILE FROM THE PRODUCTION DIMENSIONS / LONGUEUR ET LARGUEUR: MARGE DE TOLÉRANCE, EN %, ENTRE LA DIMENSION MOYENNE DE CHAQUE CARREAU ET LA DIM. DE FABRICATION / LÄNGE UND BREITE: ZULASSIGE ABWEICHUNG DES DURCHSCHNITTMÄßES JEDER FLIESE VOM HERSTELLMAß IN PROZENTEN / LARGO Y ANCHO: DESVIACION ADMISIBLE, EN %, DEL TAMAÑO MEDIO DE CADA BALDOSA A PARTIR DEL TAMAÑO DE FABRICACIÓN.	Squadrato ISO 13006	±0,3%	±1,0 mm	±0,15%	
	DEVIAZIONE AMMISSIBILE, IN PERCENTO, DELLO SPESORE MEDIO DI OGNI PIASTRELLA DALLA DIMENSIONE DI FABBRICAZIONE / ADMITTED DEVIATION, IN %, OF THE AVERAGE THICKNESS OF EACH TILE FROM THE PRODUCTION DIMENSIONS / MARGE DE TOLÉRANCE, EN POURCENTAGE, ENTRE L'ÉPAISSEUR MOYENNE DE CHAQUE CARREAU ET LA DIMENSION DE FABRICATION / ZULASSIGE ABWEICHUNG DER DURCHSCHNITTSDICKE JEDER FLIESE VOM HERSTELLMAß IN PROZENTEN / DESVIACION ADMISIBLE, EN TANTO POR CIENTO, DEL GROSOR MEDIO DE CADA BALDOSA A PARTIR DEL TAMAÑO DE FABRICACIÓN.	Squadrato ISO 13006	±5%	±0,5 mm	±5%	
	DEVIAZIONE MASSIMA DI RETTILINEARITÀ, IN PERCENTO, IN RAPPORTO ALLE DIMENSIONI DI FABBRICAZIONE CORRISPONDENTI / MAXIMUM STRAIGHTNESS DEVIATION, IN %, IN RELATION TO THE CORRESPONDING PRODUCTION DIMENSIONS / MARGE DE TOLÉRANCE DE RECTITUDE, EN POURCENTAGE, PAR RAPPORT AUX DIMENSIONS DE FABRICATION CORRÉSPONDANTES / ZULASSIGE HOCHSTABWEICHUNG DER KANTENGERADHEIT IM VERHÄLTNIß ZU DEN ENTSPRECHENDEN HERSTELLMAßEN IN PROZENTEN / DESVIACION MÁXIMA DE RECTITUD, EN TANTO POR CIENTO, EN RELACION CON EL TAMAÑO DE FABRICATION CORRÉSPONDIENTE.	Squadrato ISO 13006	±0,3%	±0,8 mm	±0,10%	ISO 10545-2
	DEVIAZIONE MASSIMA DI ORTOGONALITÀ, IN PERCENTO, IN RAPPORTO ALLE DIMENSIONI DI FABBRICAZIONE CORRISPONDENTI / MAXIMUM RIGHT-ANGLE DEVIATION, IN %, IN RELATION TO THE CORRESPONDING PRODUCTION DIMENSIONS / MARGE DE TOLÉRANCE D'ANGULARITÉ, EN POURCENTAGE, PAR RAPPORT AUX DIMENSIONS DE FABRICATION / HOCHSTABWEICHUNG DER RECHTWINKLIGKEIT IM VERHÄLTNIß ZU DEN ENTSPRECHENDEN HERSTELLMAßEN IN PROZENTEN / DESVIACION MÁXIMA DE LA ORTOGONALIDAD, EN TANTO POR CIENTO, EN RELACION CON EL TAMAÑO DE FABRICATION CORRÉSPONDIENTE.	Squadrato ISO 13006	±0,3%	±1,5 mm	±0,20%	
	PLANARITÀ (CURVATURA DEL CENTRO, DELLO SPIGOLO E SVERGOLAMENTO) / FLATNESS (CURVING IN THE MIDDLE, CORNER AND WARPING) / PLANÉITÉ (COURBURE CENTRALE, DE L'ARÊTE ET GAUCHISSEMENT) / EBENFLÄCHIGKEIT (KRÜMMUNG DER MITTE, DER KANTE UND VERWINDUNG) / PLANITUD (CURVATURA DEL CENTRO, DE LA ARISTA Y ABARQUILLAMIENTO).	Squadrato ISO 13006	±0,4%	±1,8 mm	±0,20%	
	QUALITÀ DELLA SUPERFICIE - SURFACE QUALITY / QUALITÉ DE LA SURFACE QUALITÄT DER OBERFLÄCHE / CALIDAD DE LA SUPERFICIE.				CONFORME/CONFORMING CONFORME/KONFORM CONFORME.	
	MASSA D'ACQUA ASSORBITA IN % / % WATER ABSORPTION - MASSE D'EAU ABSORBÉE EN % WASSERAUFNAHME IN % / MASA DE AGUA ABSORBIDA EN %		E≤0,5%		valore medio 0,08%	ISO 10545-3
	FORZA DI ROTTURA IN N (sp. < 7,5 mm) - BREAKING STRENGTH IN N (thickness < 7,5 mm) / FORCE DE RUPTURE EN N (ép. < 7,5 mm) / BRUCHLAST IN N (Dicke < 7,5 mm) / FUERZA DE ROTURA EN N (gr. < 7,5 mm).		≥ 700 N		valore medio 1350 N	ISO 10545-4
	RESISTENZA ALLA FLESSIONE IN N/mm <sub>2</sub> / N/mm <sub>2</sub> , FLEXURAL STRENGTH TEST / RESISTENCIA A LA FLEXION EN N/mm <sub>2</sub> / BIEGEFESTIGKEIT IN N/mm <sub>2</sub> / RESISTENCIA A LA FLEXIÓN EN N/mm <sub>2</sub>		35 MIN. N/mm <sub>2</sub>		valore medio 52 N/mm <sub>2</sub>	
	RESISTENZA ALL'ABRASIONE PROFONDA DELLE PIASTRELLE NON SMALTATE / RESISTANCE TO DEEP ABRASION OF UNGLAZED TILES / RESISTANCE À L'ABRASION PROFONDE DES CARREAUX NON ÉMAILLÉS / TIEFENABRIEFESTIGKEIT UNGLASIRTER FLIESEN / RESISTENCIA A LA ABRASION PROFUNDA DE LAS BALDOSAS SIN ESMALTAR		<175mm <sup>3</sup>		valore medio 140mm <sup>3</sup>	ISO 10545-6
	RESISTENZA AGLI SBALZI TERMICI / THERMAL SHOCKS RESISTANT / RESISTANCE AUX VARIATIONS THERMIQUES TEMPERATURWECHSELBESTÄNDIGKEIT / RESISTENCIA AL CHOQUE TÉRMICO.		-		RESISTE - RÉSISTANT - RÉSISTE ERFÜLLT - RESISTE	ISO 10545-9
	RESISTENZA AL GELO / FROST RESISTANCE - RESISTANCE AU GEL / FROSTSICHERHEIT RESISTENCIA A LA HELADA		RICHIESTA/REQUIRED/REQUISE GEFORDET/ REQUERIDA		RESISTE - RÉSISTANT - RÉSISTE ERFÜLLT - RESISTE	ISO 10545-12
	RESISTENZA ALLE MACCHIE / RESISTANCE TO STAINING / RESISTANCE AUX TACHES FLECKENABWEISEND / RESISTENCIA A LAS MANCHAS.		RICHIESTA/REQUIRED/REQUISE GEFORDET/ REQUERIDA		Classe 4-5	ISO 10545-14
	RILASCIO DI SOSTANZE PERICOLOSE / RELEASE OF HAZARDOUS SUBSTANCES / REJET DE SUBSTANCES DANGEREUSES / FREISETZUNG GEFÄHRLICHER STOFFE / LIBERACION DE SUSTANCIAS PELIGROSAS / CADMIO (in mg/dm <sup>2</sup> ) - PIOMBO (in mg/dm <sup>2</sup> )		METODO DI PROVA DISPONIBILE AVAILABLE TESTING METHOD MÉTHODE D'ESSAI DISPONIBLE VERFÜGBARE PRÜFMETHODE MÉTODO DE ENSAYO DISPONIBLE		CONFORME / CONFORMING CONFORME / KONFORM CONFORME	DM-1-2-2007-Reg- CE-1935-2004
	RESISTENZA A BASSE CONCENTRAZIONI DI ACIDI E ALCALI. / RESISTANCE TO LOW CONCENTRATIONS OF ACIDS AND ALKALIS. / RESISTANCE A BASSES CONCENTRATIONS D'ACIDES ET ALCALIS. / WIDERSTAND GEGEN NIEDRIGE KONZENTRATIONEN VON SÄUREN UND LAUGEN. / RESISTENCIA A BAJAS CONCENTRACIONES DE ACIDOS Y ALCALIS.		COME DICHIARATO DAL PRODUTTORE SEE MANUFACTURER'S DECLARATION SELON DÉCLARATION DU PRODUCTEUR ENTSPRECHEND DER HERSTELLERANGABEN TAL COMO DECLARA EL FABRICANTE		LA	ISO 10545-13
	RESISTENZA AI PRODOTTI CHIMICI DI USO DOMESTICO E AGLI ADDITIVI PER PISCINA / RESISTENCE TO DOMESTIC CHEMICAL PRODUCTS AND ADDITIVES FOR SWIMMING POOLS / RÉSISTANT AUX PRODUITS CHIMIQUES À USAGE DOMESTIQUE ET AUX ADDITIFS POUR PISCINE / WIDERSTAND GEGEN HAUSHALTSCHENIKALIEN UND SCHWIMMBADZUSATZSTOFFEN / RESISTENCIA A PRODUCTOS PARA LIMPIEZA DOMESTICA Y ADITIVOS PARA PISCINAS		B min		A	
	COEFFICIENTE D'ATTRITO (SCIVOLosità) / FRICTION COEFFICIENT (SLIPPERINESS) / COEFFICIENT DE FRICTION (GLISSEMENT) / REIBUNGSKOEFFIZIENT (SCHLÜPFRIEGEIT) - COEFICIENTE DE ANTI DESLIZAMIENTO				10° < α ≤ 19° R10	DIN EN 16165 ANNEX B
					18° ≤ α < 24° classe B	DIN EN 16165 ANNEX A
					PTV > 36 wet slider 96	BS EN 16165 ANNEX C
					> 0,42 wet	ANSI A 326.3











Per un effetto ottimale della posa, florim suggerisce di mantenere 2 mm di fuga per pose monofornate e 3 mm per combinare formati misti / For optimal installation results, florim recommends maintaining a joint of 2 mm 1/12" for single format installations and 3 mm 1/8" to combine mixed formats / Pour réaliser une pose parfaite, florim suggère de maintenir 2 mm de joint pour la pose des monofornats, et 3 mm pour les combinaisons de formats mixtes / Um einen optimalen effekt beim verlegen zu erzielen empfehlt florim eine 2 mm fuge bei einformatigen verlegungen und 3 mm fuge bei formatkombinationen / Para lograr los máximos resultados en la posa del producto, florim aconseja 2 mm de junta en aplicaciones monofornato y 3 mm en combinaciones de formatos mixtos.



# PLIMATECH

GRES FINE PORCELLANATO/FINE PORCELAIN STONWARE/GRES CERAME FIN/FEINSTEINZEUG-KOLLEKTIONEN/GRES PORCELANICO FINO  
SQUADRATO - SQUARED - EQUARRI - REKTIFIZIERT - ESCUADRADO

6 mm 1/4" 

CARATTERISTICHE TECNICHE - TECHNICAL CHARACTERISTICS - CARACTERISTIQUES TECHNIQUES - TECHNISCHE EIGENSCHAFTEN - CARACTERÍSTICAS TÉCNICAS		PRESCRIZIONE STANDARD REQUIREMENTS PRESCRIPTIONS ANFORDERUNGEN PRESCRIPCION		RISULTATI TESTS TEST RESULTS RESULTATS DES ESSAIS PRÜFERGEBNIS RESULTADOS TESTS		RIFERIMENTO NORMA REFERENCE STANDARD REFFERENZ NORME STANDARDWERT REFERENCIA NORMA
Lastre in gres fine porcellanato non smaltato. Piastrelle di ceramica pressate a secco. Caratteristiche di qualità secondo i test di controllo previsti dalla norma EN 14411-ISO 13006 Appendice Gruppo Bla UGL. / Unglazed porcelain stoneware slabs. Dry-pressed ceramic tiles. Quality specifications, according to control tests of EN 14411-ISO 13006 Appendix G group Bla UGL. / Dalles en gres cérame fin non émaillé. Carreaux céramiques pressés à sec. Caractéristiques de qualité d'après les essais de contrôle norme EN 14411-ISO 13006 Appendice G groupe B1a UGL. / Nicht glasierte und vollständig gesinterte Feinsteinzeugplatten. Trocken gepresste Keramikfliesen. Qualitätseigenschaften nach Normen EN 14411-ISO 13006 Anhang G Gruppe Bla UGL. / Planchas de gres porcelánico fino no esmaltado. Baldosas de cerámica rensadas en seco. Características de calidad según las Normas EN 14411-ISO 13006 Apéndice G grupo Bla UGL.		N ≥ 15 cm		N ≥ 15 cm		
		(%)	(mm)	matte		
	LUNGHEZZA E LARGHEZZA: DEVIAZIONE AMMISSIBILE, IN %, DELLA DIMENSIONE MEDIA DI OGNI PIASTRELLA DALLA DIM. DI FABBRICAZIONE / LENGTH AND WIDTH: ADMITTED DEVIATION, IN %, OF THE AVERAGE SIZE OF EACH TILE FROM THE PRODUCTION DIMENSIONS / LONGUEUR ET LARGEUR: MARGE DE TOLERANCE, EN %, ENTRE LA DIMENSION MOYENNE DE CHAQUE CARREAU ET LA DIM. DE FABRICATION / LANGE UND BREITE: ZULASSIGE ABWEICHUNG DES DURCHSCHNITTMASSES JEDER FLIESE VOM HERSTELLMAß IN PROZENTEN / LARGO Y ANCHO: DESVIACION ADMISIBLE, EN %, DEL TAMAÑO MEDIO DE CADA BALDOSA A PARTIR DEL TAMAÑO DE FABRICACION.	Squadrato ISO 13006	±0,3%	±1,0mm	±0,15%	ISO 10545-2
	DEVIAZIONE AMMISSIBILE, IN PERCENTO, DELLO SPESSORE MEDIO DI OGNI PIASTRELLA DALLA DIMENSIONE DI FABBRICAZIONE / ADMITTED DEVIATION, IN %, OF THE AVERAGE THICKNESS OF EACH TILE FROM THE PRODUCTION DIMENSIONS / MARGE DE TOLERANCE, EN POURCENTAGE, ENTRE L'ÉPAISSEUR MOYENNE DE CHAQUE CARREAU ET LA DIMENSION DE FABRICATION / ZULASSIGE ABWEICHUNG DER DURCHSCHNITTSDICKE JEDER FLIESE VOM HERSTELLMAß IN PROZENTEN / DESVIACION ADMISIBLE, EN TANTO POR CIENTO, DEL GROSOR MEDIO DE CADA BALDOSA A PARTIR DEL TAMAÑO DE FABRICACION.	-	±5%	±0,5mm	±5%	ISO 10545-2
	DEVIAZIONE MASSIMA DI RETTILINEARITÀ, IN PERCENTO, IN RAPPORTO ALLE DIMENSIONI DI FABBRICAZIONE CORRISPONDENTI / MAXIMUM STRAIGHTNESS DEVIATION, IN %, IN RELATION TO THE CORRESPONDING PRODUCTION DIMENSIONS / MARGE DE TOLERANCE DE RECTITUDE, EN POURCENTAGE, PAR RAPPORT AUX DIMENSIONS DE FABRICATION CORRESPONDANTES / ZULASSIGE HÖCHSTABWEICHUNG DER KANTENGERÄDHEIT IM VERHÄLTNIß ZU DEN ENTSPRECHENDEN HERSTELLMAßEN IN PROZENTEN / DESVIACION MÁXIMA DE RECTITUD, EN TANTO POR CIENTO, EN RELACION CON EL TAMAÑO DE FABRICACION CORRESPONDIENTE.	Squadrato ISO 13006	±0,3%	±0,8mm	±0,10%	ISO 10545-2
	DEVIAZIONE MASSIMA DI ORTOGONALITÀ, IN PERCENTO, IN RAPPORTO ALLE DIMENSIONI DI FABBRICAZIONE CORRISPONDENTI / MAXIMUM RIGHT-ANGLE DEVIATION, IN %, IN RELATION TO THE CORRESPONDING PRODUCTION DIMENSIONS / MARGE DE TOLERANCE D'ANGULARITÉ, EN POURCENTAGE, PAR RAPPORT AUX DIMENSIONS DE FABRICATION / HÖCHSTABWEICHUNG DER RECHTWINKLIGKEIT IM VERHÄLTNIß ZU DEN ENTSPRECHENDEN HERSTELLMAßEN IN PROZENTEN / DESVIACION MÁXIMA DE LA ORTOGONALIDAD, EN TANTO POR CIENTO, EN RELACION CON EL TAMAÑO DE FABRICACION CORRESPONDIENTE.	Squadrato ISO 13006	±0,3%	±1,5mm	±0,20%	ISO 10545-2
	PLANARITÀ (CURVATURA DEL CENTRO, DELLO SPINGOLO E SVERGOLAMENTO) / FLATNESS (CURVING IN THE MIDDLE CORNER AND WARPING) / PLANÉITÉ (COURBURE CENTRALE, DE L'ARÊTE ET GAUCHISSEMENT) / EBENFLÄCHIGKEIT (KRÜMMUNG DER MITTE, DER KANTE UND VERWINDUNG) / PLANITUD (CURVATURA DEL CENTRO, DE LA ARISTA Y ABARQUILLAMIENTO).	Squadrato ISO 13006	±0,4%	±1,8mm	±0,20%	ISO 10545-2
	QUALITÀ DELLA SUPERFICIE / SURFACE QUALITY / QUALITÉ DE LA SURFACE / QUALITÄT DER OBERFLÄCHE / CALIDAD DE LA SUPERFICIE.				CONFORME/CONFORMING CONFORME/CONFORM CONFORME	ISO 10545-2
	MASSA D'ACQUA ASSORBITA IN % / % WATER ABSORPTION - MASSE D'EAU ABSORBÉE EN % / WASSERAUFNAHME IN % / MASA DE AGUA ABSORBIDA EN %		< 0,5%		valore medio 0,08%	ISO 10545-3
	FORZA DI ROTTURA IN N (sp. < 7,5 mm) - BREAKING STRENGTH IN N (thickness < 7,5 mm) / FORCE DE RUPTURE EN N (ép. < 7,5 mm) / BRUCHLAST IN N (Dicke < 7,5 mm) / FUERZA DE ROTURA EN N (gr. < 7,5 mm).		≥ 700 N		valore medio 1350 N	ISO 10545-4
	RESISTENZA ALLA FLESSIONE IN N/mm <sub>2</sub> / N/mm <sub>2</sub> FLEXURAL STRENGTH TEST / RESISTENCIA A LA FLEXION EN N/mm <sub>2</sub> / BIEGEFESTIGKEIT IN N/mm <sub>2</sub> / RESISTENCIA A LA FLEXIÓN EN N/mm <sub>2</sub>		35 MIN. N/mm <sub>2</sub>		valore medio 52 N/mm <sub>2</sub>	ISO 10545-4
	RESISTENZA ALL'ABRAZIONE PROFONDA DELLE PIASTRELLE NON SMALTATE / RESISTANCE TO DEEP ABRASION OF UNGLAZED TILES / RESISTENCIA A LA ABRASION PROFONDA DE LAS BALDOSAS SIN ESMALTAR.		< 175 mm <sup>3</sup>		valore medio 140 mm <sup>3</sup>	ISO 10545-6
	RESISTENZA AGLI SBALZI TERMICI / THERMAL SHOCKS RESISTANT / RESISTENCIA AUX VARIATIONS THERMIQUES / TEMPERATURWECHSELBESTÄNDIGKEIT / RESISTENCIA AL CHOQUE TERMICO.		Metodo di prova disponibile / Available testing method Méthode d'essai disponible / Verfügbare Prüfmethode Método de ensayo disponible		RESISTE - RÉSISTANT RESISTE - ERFÜLLT RESISTE	ISO 10545-9
	RESISTENZA AL GELO / FROST RESISTANCE / RESISTANCE AU GEL / FROSTSICHERHEIT RESISTENCIA A LA HELADA		RICHIESTA - REQUIRED REQUIRE - GEFORDERT REQUERIDA		RESISTE - RÉSISTANT RESISTE - ERFÜLLT RESISTE	ISO 10545-12
	RESISTENZA ALLE MACCHIE / RESISTANCE TO STAINING / RESISTANCE AUX TACHES / FLECKENABWEISEND / RESISTENCIA A LAS MANCHAS.		Metodo di prova disponibile / Available testing method Méthode d'essai disponible / Verfügbare Prüfmethode Método de ensayo disponible		Classe 4-5	ISO 10545-14
	RLASCIO DI SOSTANZE PERICOLOSE / RELEASE OF HAZARDOUS SUBSTANCES / REJET DE SUBSTANCES DANGEREUSES / FREISETZUNG GEFAHRLICHER STOFFE / LIBERACIÓN DE SUSTANCIAS PELIGROSAS / CADMIO (in mg/dm <sup>2</sup> ) - PIOMBO (in mg/dm <sup>2</sup> )		VALORE DICHIARATO PER SUPERFICI GL CON IMPREGN SU PAVI DI LAVORO / DECLARÉ VALUE FOR GL SURFACES USED ON WORKTOPS / VALEUR DÉCLARÉE POUR SURFACES GL UTILISÉES SUR PLANS DE TRAVAIL / ANGEBORENER WERT FÜR GL OBERFLÄCHEN ZUM GEBRAUCH ALS ARBEITSPLATTEN / VALOR DECLARADO PARA ACABADOS GL UTILIZADOS PARA SUPERFICIES DE TRABAJO		CONFORME/CONFORMING CONFORME/CONFORM CONFORME	DM-1-2-2007-Reg- CE-1935-2004
	RESISTENZA A BASSE CONCENTRAZIONI DI ACIDI E ALCALI. / RESISTANCE TO LOW CONCENTRATIONS OF ACIDS AND ALKALIS. / RESISTENCIA A BASSAS CONCENTRACIONES D'ACIDES ET ALCALIS. / WIDERSTAND GEGEN NIEDRIGE KONZENTRATIONEN VON SAUREN UND LAUGEN. / RESISTENCIA A BAJAS CONCENTRACIONES DE ACIDOS Y ALCALIS.		COME DICHIARATO DAL PRODUTTORE SEE MANUFACTURERS DECLARATION SELON DECLARATION DU PRODUCTEUR ENTSPRECHEND DER HERSTELLERANGABEN TAL COMO DECLARA EL FABRICANTE		LA  A	ISO 10545-13
	RESISTENZA AI PRODOTTI CHIMICI DI USO DOMESTICO E AGLI ADDITIVI PER PISCINA / RESISTANCE TO DOMESTIC CHEMICAL PRODUCTS AND ADDITIVES FOR SWIMMING POOLS / RESISTANT AUX PRODUITS CHIMIQUES A USAGE DOMESTIQUE ET AUX ADDITIFS POUR PISCINE / WIDERSTAND GEGEN HAUSHALTSCHIMIKALIEN UND / SCHWIMMBADZUSATZSTOFFEN / RESISTENCIA A PRODUCTOS PARA LIMPIEZA DOMESTICA Y ADITIVOS PARA PISCINAS		MIN B		A	
	COEFFICIENTE D'ATTRITO (SCIVOLosità) / FRICTION COEFFICIENT (SLIPPERINESS) / COEFFICIENT DE FRICTION (GLISSEMENT) / REIBUNGSKOEFFIZIENT (SCHLUPFRIGKEIT) / COEFICIENTE DE ANTI DESLIZAMIENTO.		-		10° < α ≤ 19° R10	DIN EN 16165 ANNEX B
			-		18° ≤ α < 24° classe B	DIN EN 16165 ANNEX A
			-		> 0,42 wet	ANSI A 326.3
			-		PTV >36 wet slider 96	BS EN 16165 ANNEX C

Per un effetto ottimale della posa, florim suggerisce di mantenere 2 mm di fuga per pose monoformato e 3 mm per combinare formati misti / For optimal installation results, florim recommends maintaining a joint of 2 mm 1/12" for single format installations and 3 mm 1/8" to combine mixed formats / Pour réaliser une pose parfaite, florim suggère de maintenir 2 mm de joint pour la pose des monoformats, et 3 mm pour les combinaisons de formats mixtes / Um einen optimalen effekt beim verlegen zu erzielen empfehlt florim eine 2 mm fuge bei einformatigen verlegungen und 3 mm fuge bei formatkombinationen / Para lograr los máximos resultados en la posa del producto, florim aconseja 2 mm de junta en aplicaciones monoformato y 3 mm en combinaciones de formatos mixtos.











CARATTERISTICHE TECNICHE - TECHNICAL CHARACTERISTICS - CARACTERÍSTICAS TÉCNICAS - TECHNISCHE EIGENSCHAFTEN - CARACTERÍSTICAS TÉCNICAS						
Lastre in gres fine porcellanato non smaltato. Piastrelle di ceramica pressate a secco. Caratteristiche di qualità secondo i test di controllo previsti dalla norma EN 14411-ISO 13006 Appendice G gruppo Bia UGL. / Unglazed porcelain stoneware slabs. Dry-pressed ceramic tiles. Quality specifications, according to control tests of EN 14411-ISO 13006 Appendix G group Bia UGL. / Dalles en grés cérame fin non émaillé. Carreaux céramiques pressés à sec. Caractéristiques de qualité d'après les essais de contrôle norme EN 14411-ISO 13006 Appendice G groupe B1a UGL. / Nicht glasierte und vollständig gesinterte Feinsteinzeugplatten. Trocken gepresste Keramikfliesen. Qualitätseigenschaften nach Normen EN 14411-ISO 13006 Anhang G Gruppe Bia UGL. / Planchas de gres porcelánico fino no esmaltado. Baldosas de cerámica remasadas en seco. Características de calidad según las Normas EN 14411-ISO 13006 Apéndice G grupo Bia UGL.		PRESCRIZIONE STANDARD REQUIREMENTS PRESCRIPTIONS ANFORDERUNGEN PRESCRIPCION		RISULTATI TESTS TEST RESULTS RESULTATS DES ESSAIS PRÜFERGEBNIS RESULTADOS TESTS		RIFERIMENTO NORMA REFERENCE STANDARD STANDARDEWERT REFERENCIA NORMA
		N ≥ 15 cm				
		(%)	(mm)	soft	matte	
	LUNGHEZZA E LARGHEZZA: DEVIAZIONE AMMISSIBILE, IN %, DELLA DIMENSIONE MEDIA DI OGNI PIASTRELLA DALLA DIM. DI FABBRICAZIONE / LENGTH AND WIDTH: ADMITTED DEVIATION, IN % OF THE AVERAGE SIZE OF EACH TILE FROM THE PRODUCTION DIMENSIONS / LONGUEUR ET LARGEUR : MARGE DE TOLÉRANCE, EN %, ENTRE LA DIMENSION MOYENNE DE CHAQUE CARREAU ET LA DIM. DE FABRICATION / LANGE UND BREITE: ZULÄSSIGE ABWEICHUNG DES DURCHSCHNITTMÄßES JEDER FLIESE VOM HERSTELLMAß IN PROZENTEN / LARGO Y ANCHO: DESVIACION ADMISIBLE, EN %, DEL TAMAÑO MEDIO DE CADA BALDOSA A PARTIR DEL TAMAÑO DE FABRICACION.	Squadrato ISO 13006	±0,3%	±1,0mm	±0,15%	ISO 10545-2
	DEVIAZIONE AMMISSIBILE, IN PERCENTO, DELLO SPESSORE MEDIO DI OGNI PIASTRELLA DALLA DIMENSIONE DI FABBRICAZIONE / AVERAGE THICKNESS OF EACH TILE FROM THE PRODUCTION DIMENSIONS / MARGE DE TOLÉRANCE, EN POURCENTAGE, ENTRE L'ÉPAISSEUR MOYENNE DE CHAQUE CARREAU ET LA DIMENSION DE FABRICATION / ZULÄSSIGE ABWEICHUNG DER DURCHSCHNITTSDICKE JEDER FLIESE VOM HERSTELLMAß IN PROZENTEN / DESVIACION ADMISIBLE, EN TANTO POR CIENTO, DEL GROSOR MEDIO DE CADA BALDOSA A PARTIR DEL TAMAÑO DE FABRICACION.	-	±5%	±0,5mm	±5%	ISO 10545-2
	DEVIAZIONE MASSIMA DI RETTILINEARITÀ, IN PERCENTO, IN RAPPORTO ALLE DIMENSIONI DI FABBRICAZIONE CORRISPONDENTI / MAXIMUM STRAIGHTNESS DEVIATION, IN %, IN RELATION TO THE CORRESPONDING PRODUCTION DIMENSIONS / MARGE DE TOLÉRANCE DE RECTITUDE, EN POURCENTAGE, PAR RAPPORT AUX DIMENSIONS DE FABRICATION CORRÉPONDANTES / ZULÄSSIGE HÖCHSTABWEICHUNG DER KANTENGERADHEIT IM VERHÄLTNIß ZU DEN ENTSPRECHENDEN HERSTELLMAßEN IN PROZENTEN / DESVIACION MÁXIMA DE RECTITUD, EN TANTO POR CIENTO, EN RELACION CON EL TAMAÑO DE FABRICACION CORRESPONDIENTE.	Squadrato ISO 13006	±0,3%	±0,8mm	±0,10%	ISO 10545-2
	DEVIAZIONE MASSIMA DI ORTOGONALITÀ, IN PERCENTO, IN RAPPORTO ALLE DIMENSIONI DI FABBRICAZIONE CORRISPONDENTI / MAXIMUM RIGHT-ANGLE DEVIATION, IN %, IN RELATION TO THE CORRESPONDING PRODUCTION DIMENSIONS / MARGE DE TOLÉRANCE D'ANGULARITÉ, EN POURCENTAGE, PAR RAPPORT AUX DIMENSIONS DE FABRICATION / HÖCHSTABWEICHUNG DER RECHTWINKLIGKEIT IM VERHÄLTNIß ZU DEN ENTSPRECHENDEN HERSTELLMAßEN IN PROZENTEN / DESVIACION MÁXIMA DE LA ORTOGONALIDAD, EN TANTO POR CIENTO, EN RELACION CON EL TAMAÑO DE FABRICACION CORRESPONDIENTE.	Squadrato ISO 13006	±0,3%	±1,5mm	±0,20%	ISO 10545-2
	PLANARITÀ (CURVATURA DEL CENTRO, DELLO SPIGOLO E SVERGOLAMENTO) / FLATNESS (CURVING IN THE MIDDLE, CORNER AND WARPING) / PLANEITÉ (COURBURE CENTRALE, DE L'ARÊTE ET GAUCHISSEMENT) / EBENFLÄCHIGKEIT (KRÜMMUNG DER MITTE, DER KANTE UND VERWINDUNG) / PLANITUD (CURVATURA DEL CENTRO, DE LA ARISTA Y ABAQUILLAMIENTO).	Squadrato ISO 13006	±0,4%	±1,8mm	±0,20%	ISO 10545-2
	QUALITÀ DELLA SUPERFICIE / SURFACE QUALITY / QUALITÉ DE LA SURFACE / QUALITÄT DER OBERFLÄCHE / CALIDAD DE LA SUPERFICIE.	Il 95% min delle piastrelle deve essere esente da difetti visibili. / At least 95% of the tiles must be free from visible flaws. / 95% min des carreaux ne doivent présenter aucun défaut visible. Mindestens 95% der Fliesen müssen frei von sichtbaren min. / el 95% de las baldosas tiene que estar exento de defectos visibles.		CONFORME/CONFORMING CONFORME/KONFORM CONFORME		ISO 10545-2
	MASSA D'ACQUA ASSORBITA IN % / % WATER ABSORPTION - MASSE D'EAU ABSORBÉE EN % / WASSERAUFNAHME IN % / MASA DE AGUA ABSORBIDA EN %		< 0,5%		valore medio 0,08%	ISO 10545-3
	FORZA DI ROTTURA IN N (sp. < 7,5 mm) - BREAKING STRENGTH IN N (thickness < 7,5 mm) / FORCE DE RUPTURE EN N (ép. < 7,5 mm) / BRUCHLAST IN N (Dicke < 7,5 mm) / FUERZA DE ROTURA EN N (gr. < 7,5 mm).		≥ 700 N		valore medio 1350 N	ISO 10545-4
	RESISTENZA ALLA FLESSIONE IN N/mm <sub>2</sub> / N/mm <sub>2</sub> FLEXURAL STRENGTH TEST / RÉSISTANCE A LA FLEXION EN N/mm <sub>2</sub> / BIEGESTÄRKE IN N/mm <sub>2</sub> / RESISTENCIA A LA FLEXIÓN EN N/mm <sub>2</sub>		35 MIN. N/mm <sub>2</sub>		valore medio 52 N/mm <sub>2</sub>	ISO 10545-4
	RESISTENZA ALL'ABRASIONE PROFONDA DELLE PIASTRELLE NON SMALTATE / RESISTANCE TO DEEP ABRASION OF UNGLAZED TILES / RESISTENCIA A L'ABRASION PROFONDE DES CARREAUX NON ÉMALLÉS / TIEFENABRIEFESTIGKEIT UNGLASIERTER FLIESEN / RESISTENCIA A LA ABRASION PROFUNDA DE LAS BALDOSAS SIN ESMALTAR.		< 175 mm <sup>3</sup>		valore medio 140 mm <sup>3</sup>	ISO 10545-6
	RESISTENZA AGLI SBALZI TERMICI / THERMAL SHOCKS RESISTANT / RÉSISTANCE AUX VARIATIONS THERMIQUES / TEMPERATURWECHSELBESTÄNDIGKEIT / RESISTENCIA AL CHOQUE TÉRMICO.	Metodo di prova disponibile / Available testing method Méthode d'essai disponible / Verfügbare Prüfmethode Método de ensayo disponible		RESISTE - RÉSISTANT RESISTE - ERFÜLLT RESISTE		ISO 10545-9
	RESISTENZA AL GELIO / FROST RESISTANCE / RÉSISTANCE AU GEL / FROSTSICHERHEIT / RESISTENCIA A LA HELADA.	RICHIESTA - REQUIRED REQUIRE - GEFORDERT REQUERIDA		RESISTE - RÉSISTANT RESISTE - ERFÜLLT RESISTE		ISO 10545-12
	RESISTENZA ALLE MACCHIE / RESISTANCE TO STAINING / RÉSISTANCE AUX TACHES / FLECKENABWEISEND / RESISTENCIA A LAS MANCHAS.	Metodo di prova disponibile / Available testing method Méthode d'essai disponible / Verfügbare Prüfmethode Método de ensayo disponible		Classe 5		ISO 10545-14
	RILASCIO DI SOSTANZE PERICOLOSE / RELEASE OF HAZARDOUS SUBSTANCES / REJET DE SUBSTANCES DANGEREUSES / FREISETZUNG GEFÄHRLICHER STOFFE / LIBERACIÓN DE SUSTANCIAS PELIGROSAS / CADMIO (in mg/dm <sup>2</sup> ) - PIOMBO (in mg/dm <sup>2</sup> )	VALORE DICHIARATO PER SUPERFICI GL CON IMPREGHI SU PIANI DI LAVORO / DECLARED VALUE FOR GL SURFACES USED IN WORKTOPS / VALEUR DÉCLARÉE POUR SURFACES GL UTILISÉES SUR PLANS DE TRAVAIL / ANGEBOBENER WERT FÜR GL OBERFLÄCHEN ZUM GEBRAUCH ALS ARBEITSPLATZEN / VALOR DECLARADO PARA ACABADOS GL UTILIZADOS PARA SUPERFICIES DE TRABAJO.		CONFORME/CONFORMING CONFORME/KONFORM CONFORME		DM-1-2-2007-Reg-CE-1935-2004
	RESISTENZA A BASSE CONCENTRAZIONI DI ACIDI E ALCALI / RESISTANCE TO LOW CONCENTRATIONS OF ACIDS AND ALKALIS / RESISTANCE A BASSES CONCENTRATIONS D'ACIDES ET ALCALIS / WIDERSTAND GEGEN NIEDRIGE KONZENTRATIONEN VON SAUREN UND LAUGEN. / RESISTENCIA A BAJAS CONCENTRACIONES DE ACIDOS Y ALCALIS.	COME DICHIARATO DAL PRODUTTORE SEE MANUFACTURER'S DECLARATION SELON DÉCLARATION DU PRODUCTEUR ENTSPRECHEND DER HERSTELLERANGABEN TAL COMO DECLARA EL FABRICANTE		LB	LA	ISO 10545-13
	RESISTENZA AI PRODOTTI CHIMICI DI USO DOMESTICO E AGLI ADDITIVI PER PISCINA / RESISTENCE TO DOMESTIC CHEMICAL PRODUCTS AND ADDITIVES FOR SWIMMING POOLS / RÉSISTANT AUX PRODUITS CHIMIQUES À USAGE DOMESTIQUE ET AUX ADDITIFS POUR PISCINE / WIDERSTAND GEGEN HAUSHALTSCHIMIKALIEN UND / SCHWIMMBADZUSATZSTOFFEN / RESISTENCIA A PRODUCTOS PARA LIMPIEZA DOMESTICA Y ADITIVOS PARA PISCINAS		MIN B		A	ISO 10545-13
	COEFFICIENTE D'ATTRITO (SCIVOLosità) / FRICTION COEFFICIENT (SLIPPERINESS) / COEFFICIENT DE FRICTION (GLISSEMENT) / REIBUNGSKOEFFIZIENT (SCHLUPFRIGKEIT) / COEFFICIENTE DE ANTI DESLIZAMIENTO.		-	6° < α ≤ 10° R9	10° < α ≤ 19° R10	DIN EN 16165 ANNEX B
			-	-	18° ≤ α < 24° classe B	DIN EN 16165 ANNEX A

Per un effetto ottimale della posa, florim suggerisce di mantenere 2 mm di fuga per pose monofornato e 3 mm per combinare formati misti / For optimal installation results, florim recommends maintaining a joint of 2 mm 1/12" for single format installations and 3 mm 1/8" to combine mixed formats / Pour réaliser une pose parfaite, florim suggère de maintenir 2 mm de joint pour la pose des monofornats, et 3 mm pour les combinaisons de formats mixtes / Um einen optimalen effekt beim verlegen zu erzielen empfiehlt florim eine 2 mm fugje bei einformatigen verlegungen und 3 mm fugje bei formatkombinationen / Para lograr los máximos resultados en la posa del producto, florim aconseja 2 mm de junta en aplicaciones monofornato y 3 mm en combinaciones de formatos mixtos.

# CORETECH

GRES FINE PORCELLANATO/FINE PORCELAIN STONWARE/GRES CERAME FIN/FEINSTEINZEUG-KOLLEKTIONEN/GRES PORCELANICO FINO  
SQUADRATO - SQUARED - EQUARRI - REKTIFIZIERT - ESCUADRADO

6 mm 1/4" 

CARATTERISTICHE TECNICHE - TECHNICAL CHARACTERISTICS - CARACTERISTIQUES TECHNIQUES - TECHNISCHE EIGENSCHAFTEN - CARACTERÍSTICAS TÉCNICAS						
		PRESCRIZIONE STANDARD REQUIREMENTS PRESCRIPTIONS ANFORDERUNGEN PRESCRIPCION	RISULTATI TESTS TEST RESULTS RESULTATS DES ESSAIS PRÜFERGEBNIS RESULTADOS TESTS		RIFERIMENTO NORMA REFERENCE STANDARD REFERENCIA NORMA STANDARDWERT REFERENCIA NORMA	
			N ≥ 15 cm			
			(%)	(mm)		soft
	LUNGHEZZA E LARGHEZZA: DEVIAZIONE AMMISSIBILE, IN %, DELLA DIMENSIONE MEDIA DI OGNI PIASTRELLA DALLA DIM. DI FABBRICAZIONE / LENGTH AND WIDTH: ADMITTED DEVIATION, IN %, OF THE AVERAGE SIZE OF EACH TILE FROM THE PRODUCTION DIMENSIONS / LONGUEUR ET LARGEUR: MARGE DE TOLÉRANCE, EN %, ENTRE LA DIMENSION MOYENNE DE CHAQUE CARREAU ET LA DIM. DE FABRICATION / LANGE UND BREITE: ZULÄSSIGE ABWEICHUNG DES DURCHSCHNITTSMAßES JEDER FLESE VOM HERSTELLMAß IN PROZENTEN / LARGO Y ANCHO: DESVIACION ADMISIBLE, EN %, DEL TAMAÑO MEDIO DE CADA BALDOSA A PARTIR DEL TAMAÑO DE FABRICACION.	Squadrato ISO 13006	±0,3%	±1,0mm	±0,15%	ISO 10545-2
	DEVIAZIONE AMMISSIBILE, IN PERCENTO, DELLO SPESORE MEDIO DI OGNI PIASTRELLA DALLA DIMENSIONE DI FABBRICAZIONE / ADMITTED DEVIATION, IN %, OF THE AVERAGE THICKNESS OF EACH TILE FROM THE PRODUCTION DIMENSIONS / MARGE DE TOLÉRANCE, EN POURCENTAGE, ENTRE L'ÉPAISSEUR MOYENNE DE CHAQUE CARREAU ET LA DIMENSION DE FABRICATION / ZULÄSSIGE ABWEICHUNG DER DURCHSCHNITTSDICKE JEDER FLESE VOM HERSTELLMAß IN PROZENTEN / DESVIACION ADMISIBLE, EN TANTO POR CIENTO, DEL GROSOR MEDIO DE CADA BALDOSA A PARTIR DEL TAMAÑO DE FABRICACION.	Squadrato ISO 13006	±5%	±0,5mm	±5%	ISO 10545-2
	DEVIAZIONE MASSIMA DI RETTILINEARITÀ IN PERCENTO, IN RAPPORTO ALLE DIMENSIONI DI FABBRICAZIONE CORRISPONDENTI / MAXIMUM STRAIGHTNESS DEVIATION, IN %, IN RELATION TO THE CORRESPONDING PRODUCTION DIMENSIONS / MARGE DE TOLÉRANCE DE RECTITUDE, EN POURCENTAGE, PAR RAPPORT AUX DIMENSIONS DE FABRICATION / HÖCHSTABWEICHUNG DER RECHTWINKELIGKEIT IM VERHÄLTNIß ZU DEN ENTSPRECHENDEN HERSTELLMAßEN IN PROZENTEN / DESVIACION MÁXIMA DE RECTITUD, EN TANTO POR CIENTO, EN RELACION CON EL TAMAÑO DE FABRICACION CORRISPONDIENTE.	Squadrato ISO 13006	±0,3%	±0,8mm	±0,10%	ISO 10545-2
	DEVIAZIONE MASSIMA DI ORTOGONALITÀ IN PERCENTO, IN RAPPORTO ALLE DIMENSIONI DI FABBRICAZIONE CORRISPONDENTI MAXIMUM RIGHT-ANGLE DEVIATION, IN %, IN RELATION TO THE CORRESPONDING PRODUCTION DIMENSIONS / MARGE DE TOLÉRANCE D'ANGULARITÉ, EN POURCENTAGE, PAR RAPPORT AUX DIMENSIONS DE FABRICATION / HÖCHSTABWEICHUNG DER RECHTWINKELIGKEIT IM VERHÄLTNIß ZU DEN ENTSPRECHENDEN HERSTELLMAßEN IN PROZENTEN / DESVIACION MÁXIMA DE LA ORTOGONALIDAD, EN TANTO POR CIENTO, EN RELACION CON EL TAMAÑO DE FABRICACION CORRISPONDIENTE.	Squadrato ISO 13006	±0,3%	±1,5mm	±0,20%	ISO 10545-2
	PLANARITÀ (CURVATURA DEL CENTRO, DELLO SPIGOLO E SVERGOLAMENTO) / FLATNESS (CURVING IN THE MIDDLE, CORNER AND WARPING) / PLANÉITÉ (COURBURE CENTRALE, DE L'ARÊTE ET GAUCHISSEMENT) / EBENFLÄCHIGKEIT (KRÜMMUNG DER MITTE, DER KANTE UND VERWINDUNG) / PLANITUD (CURVATURA DEL CENTRO, DE LA ARISTA Y ABAQUILLAMIENTO).	Squadrato ISO 13006	±0,4%	±1,8mm	±0,20%	ISO 10545-2
	QUALITÀ DELLA SUPERFICIE / SURFACE QUALITY / QUALITÉ DE LA SURFACE / QUALITÄT DER OBERFLÄCHE / CALIDAD DE LA SUPERFICIE		Il 95% min delle piastrelle deve essere esente da difetti visibili. / At least 95% of the tiles must be free from visible flaws. / 95% min des carreaux ne doivent présenter aucun défaut visible. Mindestens 95% der Fliesen müssen frei von sichtbaren min. / el 95% de las baldosas tiene que estar exento de defectos visibles.		CONFORME/CONFORMING CONFORME/KONFORM CONFORME	ISO 10545-2
	MASSA D'ACQUA ASSORBITA IN % / % WATER ABSORPTION - MASSE D'EAU ABSORBÉE EN % / WASSERAUFNAHME IN % / MASSA DE AGUA ABSORBIDA EN %		< 0,5%		valore medio 0,08%	ISO 10545-3
	FORZA DI ROTTURAZIONE IN N (sp. < 7,5 mm) - BREAKING STRENGTH IN N (thickness < 7.5 mm) / FORCE DE RUPTURE EN N (ép. < 7,5 mm) / BRUCHLAST IN N (Dicke < 7,5 mm) / FUERZA DE ROTURA EN N (gr. < 7,5 mm).		≥ 700 N		valore medio 1350 N	ISO 10545-4
	RESISTENZA ALLA FLESSIONE IN N/mm <sub>2</sub> / N/mm <sub>2</sub> FLEXURAL STRENGTH TEST / RÉSISTANCE A LA FLEXION EN N/mm <sub>2</sub> / BIEGEFESTIGKEIT IN N/mm <sub>2</sub> / RESISTENCIA A LA FLEXION EN N/mm <sub>2</sub>		35 MIN. N/mm <sub>2</sub>		valore medio 52 N/mm <sub>2</sub>	ISO 10545-4
	RESISTENZA ALL'ABRASIONE PROFONDA DELLE PIASTRELLE NON SMALTATE / RESISTANCE TO DEEP ABRASION OF UNGLAZED TILES / RÉSISTANCE À L'ABRASION PROFONDE DES CARREAUX NON ÉMALLÉS / TIEFENABRIEFESTIGKEIT UNGLASIERTER FLESEN / RESISTENCIA A LA ABRASIÓN PROFUNDA DE LAS BALDOSAS SIN ESMALTAR.		< 175 mm <sup>3</sup>		valore medio 140 mm <sup>3</sup>	ISO 10545-6
	RESISTENZA AGLI SBALZI TERMICI / THERMAL SHOCKS RESISTANT / RÉSISTANCE AUX VARIATIONS THERMIQUES / TEMPERATURWECHSELBESTÄNDIGKEIT / RESISTENCIA AL CHOCQUE TÉRMICO.		Metodo di prova disponibile / Available testing method Méthode d'essai disponible / Verfügbare Prüfmethode Método de ensayo disponible		RESISTE - RESISTANT RÉSISTE - ÉRUFFLT RESISTE	ISO 10545-9
	RESISTENZA AL GEL / FROST RESISTANCE / RÉSISTANCE AU GEL / FROSTSICHERHEIT / RESISTENCIA A LA HELADA		RICHIESTA - REQUIRED REQUIRE - GEFORDERT REQUERIDA		RESISTE - RESISTANT RÉSISTE - ÉRUFFLT RESISTE	ISO 10545-12
	RESISTENZA ALLE MACCHIE / RESISTANCE TO STAINING / RÉSISTANCE AUX TACHES / FLECKENABWEISEND / RESISTENCIA A LAS MANCHAS.		Metodo di prova disponibile / Available testing method Méthode d'essai disponible / Verfügbare Prüfmethode Método de ensayo disponible		Classe 5	ISO 10545-14
	RILASCIO DI SOSTANZE PERICOLOSE / RELEASE OF HAZARDOUS SUBSTANCES / RIJET DE SUBSTANCES DANGEREUSES / FREISETZUNG GEFÄHRLICHER STOFFE / LIBERACIÓN DE SUSTANCIAS PELIGROSAS / CADMIO (in mg/dm <sup>2</sup> ) - PIOMBO (in mg/dm <sup>2</sup> )		VALORE DICHIARATO PER SUPERFICI GL CON IMPREGHI SU PIANI DI LAVORO / DECLARED VALUE FOR GL SURFACES USED ON WORKTOPS / VALEUR DÉCLARÉE POUR SURFACES GL UTILISÉES SUR PLANS DE TRAVAIL / ANGEBOBENER WERT FÜR GL OBERFLÄCHEN ZUM GEBRAUCH ALS ARBEITSPLETTEN / VALOR DECLARADO PARA ACABADOS GL UTILIZADOS PARA SUPERFICIES DE TRABAJO		CONFORME/CONFORMING CONFORME/KONFORM CONFORME	DM-1-2-2007-Reg-CE-1935-2004
	RESISTENZA A BASSE CONCENTRAZIONI DI ACIDI E ALCALI / RESISTANCE TO LOW CONCENTRATIONS OF ACIDS AND ALKALIS / RESISTANCE A BASSES CONCENTRATIONS D'ACIDES ET ALCALIS / WIDERSTAND GEGEN NIEDRIGE KONZENTRATIONEN VON SAUREN UND LAUGEN. / RESISTENCIA A BAJAS CONCENTRACIONES DE ACIDOS Y ALCALIS.		COME DICHIARATO DAL PRODUTTORE SEE MANUFACTURER'S DECLARATION SELON DÉCLARATION DU PRODUCTEUR ENTSPRECHEND DER HERSTELLERANGABEN TAL COMO DECLARA EL FABRICANTE		LA	ISO 10545-13
	RESISTENZA AI PRODOTTI CHIMICI DI USO DOMESTICO E AGLI ADDITIVI PER PISCINA / RESISTENCE TO DOMESTIC CHEMICAL PRODUCTS AND ADDITIVES FOR SWIMMING POOLS / RÉSISTANT AUX PRODUITS CHIMIQUES À USAGE DOMESTIQUE ET AUX ADDITIFS POUR PISCINE / WIDERSTAND GEGEN HAUSHALTSCHIMIKALIEN UND / SCHWIMMBADZUSATZSTOFFE / RESISTENCIA A PRODUCTOS PARA LIMPIEZA DOMESTICA Y ADITIVOS PARA PISCINAS		MIN B		A	
				6° < α ≤ 10° R9	10° < α ≤ 19° R10	DIN EN 16165 ANNEX B
	COEFFICIENTE D'ATTRITO (SCIVOLosità) / FRICTION COEFFICIENT (SLIPPERINESS) / COEFFICIENT DE FRICTION (GLISSEMENT) / REIBUNGSKOEFFIZIENT (SCHLUPFRIGKEIT) / COEFFICIENTE DE ANTI DESLIZAMIENTO.				18° ≤ α < 24° classe B (Flame light/Flame dark)	DIN EN 16165 ANNEX A
					> 0,42 wet	ANSI A 326.3











Per un effetto ottimale della posa, florim suggerisce di mantenere 2 mm di fuga per pose monoformato e 3 mm per combinare formati misti / For optimal installation results, florim recommends maintaining a joint of 2 mm 1/16" for single format installations and 3 mm 1/8" to combine mixed formats / Pour réaliser une pose parfaite, florim suggère de maintenir 2 mm de joint pour la pose des monoformats, et 3 mm pour les combinaisons de formats mixtes / Um einen optimalen effekt beim verlegen zu erzielen empfehlt florim eine 2 mm fuge bei einformatigen verlegungen und 3 mm fuge bei formatkombinationen / Para lograr los máximos resultados en la posa del producto, florim aconseja 2 mm de junta en aplicaciones monoformato y 3 mm en combinaciones de formatos mixtos.

# CARATTERISTICHE TECNICHE

TECHNICAL FEATURES  
CARACTÉRISTIQUES TECHNIQUES  
TECHNISCHE EIGENSCHAFTEN  
CARACTERISTICAS TÉCNICAS

9mm



CARATTERISTICHE TECNICHE - TECHNICAL CHARACTERISTICS - CARACTERISTIQUES TECHNIQUES - TECHNISCHE EIGENSCHAFTEN - CARACTERÍSTICAS TÉCNICAS						
	Lastre in gres fine porcellanato non smaltato. Piastrelle di ceramica pressate a secco. Caratteristiche di qualità secondo i test di controllo previsti dalla norma EN 14411-ISO 13006 Appendice G gruppo Bia UGL/ Unglazed porcelain stoneware slabs. Dry-pressed ceramic tiles. Quality specifications, according to control tests of EN 14411-ISO 13006 Appendix G group Bia UGL. / Dalles en grès cérame fin non émaillé. Carreaux céramiques pressés à sec. Caractéristiques de qualité d'après les essais de contrôle norme EN 14411-ISO 13006 Appendice G groupe Bia UGL/ Nicht glasierte und vollständig gesinterte Feinsteinzeugplatten. Trocken gepresste Keramikfliesen. Qualitätseigenschaften nach Normen EN 14411-ISO 13006 Anhang G Gruppe Bia UGL/ Planchas de gres porcelánico fino no esmaltado. Baldosas de cerámica rensadas en seco. Características de calidad según las Normas EN 14411-ISO 13006 Apéndice G grupo B1a UGL.	PRESCRIZIONE STANDARD REQUIREMENTS PRESCRIPTIONS ANFORDERUNGEN PRESCRIPTION		RISULTATI TESTS TEST RESULTS RESULTATS DES ESSAIS PRÜFERGEBNIS RESULTADOS TESTS	RIFERIMENTO NORMA REFERENCE STANDARD RÉFÉRENCE NORME STANDARDWERT REFERENCIA NORMA	
		N > 15 cm				
		(%)	(mm)			
	LUNGHEZZA E LARGHEZZA- DEVIAZIONE AMMISSIBILE, IN % DELLA DIMENSIONE MEDIA DI OGNI PIASTRELLA DALLA DIM. DI FABBRICAZIONE / LENGTH AND WIDTH- ADMITTED DEVIATION, IN % OF THE AVERAGE SIZE OF EACH TILE FROM THE PRODUCTION DIMENSIONS / LONGUEUR ET LARGEUR : MARGE DE TOLÉRANCE, EN % ENTRE LA DIMENSION MOYENNE DE CHAQUE CARREAU ET LA DIM. DE FABRICATION / LANGE UND BREITE: ZULASSIGE ABWEICHUNG DES DURCHSCHNITTMÄßES JEDER FLIESE VOM HERSTELLMAß IN PROZENTEN / LARGO Y ANCHO: DESVIACIÓN ADMISIBLE, EN % DEL TAMAÑO MEDIO DE CADA BALDOSA A PARTIR DEL TAMAÑO DE FABRICACION.	Non squadrato EN 14411 - ISO 13006	±0,6%	±2,0mm	±0,6%	ISO 10545-2
		Squadrato ISO 13006	±0,3%	±1,0mm	±0,15%	
	DEVIAZIONE AMMISSIBILE, IN PERCENTO, DELLO SPESSORE MEDIO DI OGNI PIASTRELLA DALLA DIMENSIONE DI FABBRICAZIONE / ADMITTED DEVIATION, IN % OF THE AVERAGE THICKNESS OF EACH TILE FROM THE PRODUCTION DIMENSIONS / MARGE DE TOLÉRANCE, EN POURCENTAGE ENTRE L'ÉPAISSEUR MOYENNE DE CHAQUE CARREAU ET LA DIMENSION DE FABRICATION / ZULASSIGE ABWEICHUNG DER DURCHSCHNITTSDICKE JEDER FLIESE VOM HERSTELLMAß IN PROZENTEN / DESVIACIÓN ADMISIBLE, EN TANTO POR CIENTO, DEL GROSOR MEDIO DE CADA BALDOSA A PARTIR DEL TAMAÑO DE FABRICACION.		±5%	±0,5mm	±5%	
	DEVIAZIONE MASSIMA DI RETTILINEARITÀ, IN PERCENTO, IN RAPPORTO ALLE DIMENSIONI DI FABBRICAZIONE CORRISPONDENTI / MAXIMUM STRAIGHTNESS DEVIATION, IN % IN RELATION TO THE CORRESPONDING PRODUCTION DIMENSIONS / MARGE DE TOLÉRANCE DE RECTITUDE, EN POURCENTAGE PAR RAPPORT AUX DIMENSIONS DE FABRICATION CORRESPONDANTES / ZULASSIGE HOCHSTABWEICHUNG DER KANTENGERADHEIT IM VERHÄLTNIS ZU DEN ENTSPRECHENDEN HERSTELLMAßEN IN PROZENTEN / DESVIACIÓN MÁXIMA DE RECTITUD, EN TANTO POR CIENTO, EN RELACION CON EL TAMAÑO DE FABRICACION CORRESPONDIENTE.	Non squadrato EN 14411 - ISO 13006	±0,5%	±1,5mm	±0,5%	
		Squadrato ISO 13006	±0,3%	±0,8mm	±0,10%	
	DEVIAZIONE MASSIMA DI ORTOGONALITÀ, IN PERCENTO, IN RAPPORTO ALLE DIMENSIONI DI FABBRICAZIONE CORRISPONDENTI / MAXIMUM RIGHT-ANGLE DEVIATION, IN % IN RELATION TO THE CORRESPONDING PRODUCTION DIMENSIONS / MARGE DE TOLÉRANCE D'ANGULARITÉ, EN POURCENTAGE PAR RAPPORT AUX DIMENSIONS DE FABRICATION / HOCHSTABWEICHUNG DER RECHTWINKLIGKEIT IM VERHÄLTNIS ZU DEN ENTSPRECHENDEN HERSTELLMAßEN IN PROZENTEN / DESVIACIÓN MÁXIMA DE LA ORTOGONALIDAD, EN TANTO POR CIENTO, EN RELACION CON EL TAMAÑO DE FABRICACION CORRESPONDIENTE.	Non squadrato EN 14411 - ISO 13006	±0,5%	±2,0mm	±0,5%	
		Squadrato ISO 13006	±0,3%	±1,5mm	±0,20%	
	PLANARITÀ (CURVATURA DEL CENTRO, DELLO SPIGOLO E SVERGOLAMENTO) / FLATNESS (CURVING IN THE MIDDLE, CORNER AND WARPING) / PLANÉITÉ (COURBURE CENTRALE, DE L'ARÊTE ET GAUCHISSEMENT) / EBENFLÄCHIGKEIT (KRÜMMUNG DER MITTE, DER KANTE UND VERWINDUNG) / PLANITUD (CURVATURA DEL CENTRO, DE LA ARISTA Y ABARQUILLAMIENTO).	Non squadrato EN 14411 - ISO 13006	±0,5%	±2,0mm	±0,35%	
		Squadrato ISO 13006	±0,4%	±1,8 mm	±0,35%	
	QUALITÀ DELLA SUPERFICIE - SURFACE QUALITY / QUALITÉ DE LA SURFACE - QUALITÄT DER OBERFLÄCHE / CALIDAD DE LA SUPERFICIE.		Il 95% min delle piastrelle deve essere esente da difetti visibili. / At least 95% of the tiles must be free from visible flaws. 95% min des carreaux ne doivent présenter aucun défaut visible. Mindestens 95% der Fliesen müssen frei von sichtbaren min. / el 95% de las baldosas tiene que estar exento de defectos visibles.		CONFORME/CONFORMING CONFORME/KONFORM CONFORME.	
 MASSA D'ACQUA ASSORBITA IN % / % WATER ABSORPTION - MASSE D'EAU ABSORBÉE EN % / WASSERAUFNAHME IN % / MASA DE AGUA ABSORBIDA EN %		E≤0,5%		valore medio 0,08%	ISO 10545-3	
 FORZA DI ROTTURA IN N (sp. ≥ 7,5 mm) - BREAKING STRENGTH IN N (thickness ≥ 7,5 mm) / FORCE DE RUPTURE EN N (ép. ≥ 7,5 mm) / BRUCHLAST IN N (Dicke ≥ 7,5 mm) / FUERZA DE ROTURA EN N (gr. ≥ 7,5 mm)		1300 min		valore medio 2200 N ( <b>spes.9mm</b> ) valore medio 14000 N ( <b>spes.20mm</b> )	ISO 10545-4	
 RESISTENZA ALLA FLESSIONE IN N/mm <sub>2</sub> / N/mm <sub>2</sub> FLEXURAL STRENGTH TEST / RÉSISTANCE A LA FLEXION EN N/mm <sub>2</sub> / BIEGFESTIGKEIT IN N/mm <sub>2</sub> / RESISTENCIA A LA FLEXIÓN EN N/mm <sub>2</sub>		35 MIN. N/mm <sub>2</sub>		valore medio 50 N/mm <sub>2</sub> ( <b>spes.9mm</b> ) valore medio 52 N/mm <sub>2</sub> ( <b>spes.20mm</b> )	ISO 10545-4	
 RESISTENZA ALL'ABRAZIONE PROFONDA DELLE PIASTRELLE NON SMALTATE / RESISTANCE TO DEEP ABRASION OF UNGLAZED TILES / RÉSISTANCE À L'ABRASION PROFONDE DES CARREAUX NON EMAILLÉS / TIEFENABRIEFESTIGKEIT UNGLASIRTER FLIESEN / RESISTENCIA A LA ABRASIÓN PROFUNDA DE LAS BALDOSAS SIN ESMALTAR		<175mm <sup>3</sup>		valore medio 140mm <sup>3</sup>	ISO 10545-6	
 RESISTENZA AGLI SBALZI TERMICI / THERMAL SHOCKS RESISTANT / RÉSISTANCE AUX VARIATIONS THERMIQUES / TEMPÉRATURWECHSELBESTÄNDIGKEIT / RESISTENCIA AL CHOQUE TÉRMICO.		-		RESISTE - RÉSISTANT RÉSISTE - ERFÜLLT RESISTE	ISO 10545-9	
 RESISTENZA ALLE MACCHIE / RESISTANCE TO STAINING / RÉSISTANCE AUX TACHES / FLECKENABWEISEND / RESISTENCIA A LAS MANCHAS		-		≥ Classe 3	ISO 10545-14	
 RESISTENZA A BASSE CONCENTRAZIONI DI ACIDI E ALCALI / RESISTANCE TO LOW CONCENTRATIONS OF ACIDS AND ALKALIS. / RESISTANCE A BASSES CONCENTRATIONS D'ACIDES ET ALCALIS. / WIDERSTAND GEGEN NIEDRIGE KONZENTRATIONEN VON SÄUREN UND LAUGEN. / RESISTENCIA A BAJAS CONCENTRACIONES DE ACIDOS Y ALCALIS.		COME DICHIARATO DAL PRODUTTORE SEE MANUFACTURER'S DECLARATION SELON DÉCLARATION DU PRODUCTEUR ENTSPRECHEND DER HERSTELLERANGABEN TAL COMO DECLARA EL FABRICANTE		vedere la serie - see the collection voir la collection - siehe der kollektion ver la coleccion	ISO 10545-13	
 RESISTENZA A ALTE CONCENTRAZIONI DI ACIDI ED ALCALI / RESISTANCE TO HIGH CONCENTRATIONS OF ACIDS AND ALKALIS. / RESISTANCE À HAUTES CONCENTRATIONS D'ACIDES ET BASES / BESTÄNDIGKEIT GEGEN STARK KONZENTRIERTE SÄUREN UND LAUGEN. / RESISTENCIA A ALTAS CONCENTRACIONES DE ACIDOS Y ALCALIS				vedere la serie - see the collection voir la collection - siehe der kollektion ver la coleccion		
 RESISTENZA AI PRODOTTI CHIMICI DI USO DOMESTICO E AGLI ADDITIVI PER PISCINA / RESISTENCE TO DOMESTIC CHEMICAL PRODUCTS AND ADDITIVES FOR SWIMMING POOLS / RÉSISTANT AUX PRODUITS CHIMIQUES À USAGE DOMESTIQUE ET AUX ADDITIFS POUR PISCINE / WIDERSTAND GEGEN HAUSHALTSCHIMIKALIEN UND SCHWIMMBADZUSATZSTOFFEN / RESISTENCIA A PRODUCTOS PARA LIMPIEZA DOMESTICA Y ADITIVOS PARA PISCINAS		B min		A		
 RESISTENZA AL GELO / FROST RESISTANCE - RÉSISTANCE AU GEL / FROSTSICHERHEIT - RESISTENCIA A LA HELADA		RICHIESTA / REQUIRED REQUISE / GEFÖRDET REQUERIDA		RESISTE - RÉSISTANT RÉSISTE - ERFÜLLT RESISTE	ISO 10545-12	
 COEFFICIENTE D'ATTRITO (SCIVOLOSITÀ) / FRICTION COEFFICIENT (SLIPPERINESS) / COEFFICIENT DE FRICTION (GLISSEMENT) / REIBUNGSKOEFFIZIENT (SCHLÜPFRIEGKEIT) - COEFICIENTE DE ANTI DESLIZAMIENTO				vedere la serie - see the collection voir la collection - siehe der kollektion ver la coleccion	-	

Per un effetto ottimale della posa, florm suggerisce di mantenere 2 mm di fuga per pose monoformato e 3 mm per combinare formati misti / For optimal installation results, florm recommends maintaining a joint of 2 mm 1/16" for single format installations and 3 mm 1/8" to combine mixed formats / Pour réaliser une pose parfaite, florm suggère de maintenir 2 mm de joint pour la pose des monoformats et 3 mm pour les combinaisons de formats mixtes / Um einen optimalen effekt beim verlegen zu erzielen empfiehlt florm eine 2 mm fuge bei einformatigen verlegungen und 3 mm fuge bei formatkombinationen / Para lograr los máximos resultados en la posa del producto, florm aconseja 2 mm de junta en aplicaciones monoformato y 3 mm en combinaciones de formatos mixtos

Per informazioni relative ai dati tecnici su marcatura CE vedere il sito [www.florm.com](http://www.florm.com) / Please refer to our web site [www.florm.com](http://www.florm.com) for technical information related to CE labeling / Pour tout renseignement sur l'avis technique de la marque CE veuillez consulter le site [www.florm.com](http://www.florm.com) / Informationen bezüglich technischer Daten zur Beschriftung CE entnehmen Sie unserer Website [www.florm.com](http://www.florm.com) / Para obtener más información y descargar las marcas CE: [www.florm.com](http://www.florm.com)



# **CERTIFICAZIONI**

CERTIFICATIONS

CERTIFICATIONS

ZERTIFIZIERUNGEN

CERTIFICACIONES



## Certificazioni di sistema / System certification / Certification de système / Systemzertifizierung / Certificación de sistema

La soddisfazione del Cliente, nel rispetto dell'Ambiente e della Sicurezza dei propri collaboratori, è la condizione essenziale per il successo della nostra azienda. Di conseguenza, Florim si impegna a porre come obiettivo prioritario il costante miglioramento dei propri prodotti e servizi. Florim Ceramiche S.p.A SB è la prima azienda nel settore a ottenere la certificazione del proprio Sistema di Gestione della Qualità, dell'Ambiente e della Salute e Sicurezza dei lavoratori e dell'Energia, in base alle norme **UNI EN ISO 9001, UNI EN ISO 14001, ISO 45001 e UNI EN ISO 50001**, relativamente a progettazione, produzione e vendita di piastrelle ceramiche in tutte le tipologie produttive.

Customer satisfaction, together with respect for the environment and for the safety of those who work with us are essential conditions for our company's success. As a result, Florim is committed to making the constant improvement of its products and services a priority. Florim Ceramiche S.p.A SB is the first company in the sector to obtain certification for its Quality Management System, its Environmental Management System and its Management System for the Health and Safety of workers and energy, according to **UNI EN ISO 9001, UNI EN ISO 14001, ISO 45001 and UNI EN ISO 50001** standards, relating to the design, manufacture and sales of ceramic tiles in all of its production types.

La satisfaction du client, dans le respect de l'environnement et de la sécurité de ses collaborateurs, est la condition essentielle au succès de notre entreprise. Florim s'engage donc à faire de l'amélioration constante de ses produits et services un objectif prioritaire. Florim Ceramiche S.p.A SB est la première entreprise du secteur à obtenir la certification de son système de gestion de la qualité, de l'environnement, de la santé et de la sécurité des employés et de l'énergie, conformément aux normes **UNI EN ISO 9001, UNI EN ISO 14001, ISO 45001 et UNI EN ISO 50001**, en matière de conception, production et vente de tous types de carreaux céramiques.

Die Zufriedenheit des Kunden unter Berücksichtigung von Umwelt und Sicherheit unserer Mitarbeiter ist die grundlegende Bedingung für den Erfolg unseres Unternehmens. Demzufolge setzt sich die Firma Florim dafür ein, die ständige Verbesserung ihrer Produkte und Dienstleistungen zum vorrangigen Ziel zu machen. Die Firma Florim Ceramiche S.p.A SB ist das erste Unternehmen in diesem Fachbereich, das die Zertifizierung seines Managementsystems der Qualität, Umwelt und Gesundheit und Sicherheit, und Energie auf Grund der Bestimmungen **UNI EN ISO 9001, UNI EN ISO 14001, ISO 45001 und UNI EN ISO 50001**, in Bezug auf Entwurf, Produktion und Verkauf von Keramikfliesen in allen Herstellungsarten erhielt.

La satisfacción del Cliente, con un respeto total del ambiente y seguridad de sus colaboradores, representa la condición esencial para el éxito de nuestra empresa. Por ello, Florim se compromete a perseguir, como objetivo prioritario, una mejora constante de sus productos y servicios. Florim Ceramiche S.p.A SB es la primera empresa en el sector que ha obtenido el certificado del Sistema de Gestión de la Calidad, Ambiente, Salud y Seguridad de los trabajadores y energía en base a la normativa **UNI EN ISO 9001, UNI EN ISO 14001, BS OHSAS 18001 y UNI EN ISO 50001**, en relación al proyecto, producción y venta de baldosas de cerámica en todas las tipologías productivas.



Sistema di gestione della Qualità:  
**Certificato n° 50 100 1271**

Sistema di gestione dell'Ambiente:  
**Certificato n° 50 100 100 74**

Sistema di gestione della Salute e Sicurezza dei lavoratori:  
**Certificato n° 50 100 13825**

Sistema di gestione dell'Energia:  
**Certificato n° 50 100 13545**

L'ente certificatore è il Technischerhungs-Verein (TÜV), che è stato scelto per la severità e il riconoscimento a livello internazionale.

The certification institute is Technischerhungs-Verein (TÜV), chosen for its stringent standards and international recognition.

L'organisme de certification est le Technischerhungs-Verein (TÜV), qui a été choisi pour sa rigueur et sa reconnaissance au niveau international.

Prüfbehörde ist der Technische Überwachungsverein (TÜV), welcher aufgrund seiner strengen Prüfkriterien und seiner internationalen Bekanntheit gewählt wurde.

El ente certificador es el Technischerhungs-Verein (TÜV), que ha sido elegido por su severidad y su reconocimiento a nivel internacional.



### BUREAU VERITAS

Bureau Veritas è il marchio che certifica la natura riciclata del materiale di cui è composto un prodotto, sottoponendo a verifica l'intero ciclo produttivo. Viene controllata e documentata la provenienza dei materiali di riciclo, il loro dosaggio, il rispetto di alcune peculiarità tecnologiche e il raggiungimento dei parametri stabiliti della norma ISO14021:2002 dell'International Organization for Standardization e

del regolamento LEED del U.S. Green Building Council (USGBC).

Per maggiori informazioni: [www.bureauveritas.com](http://www.bureauveritas.com)

Bureau Veritas is the mark that certifies the recycling of the material that goes into the making of a product, by running an inspection on the entire production cycle. Checks and documentation are carried out on the provenance of the recycled material, the quantities used, the observance of certain technological particulars and the achievement of the parameters established by the ISO14021:2002 regulations of the International Organization for Standardization and the LEED regulation of the U.S. Green Building Council (USGBC). For more information: [www.bureauveritas.com](http://www.bureauveritas.com)

Bureau Veritas est une marque qui certifie que le matériau dont un produit est composé a été recyclé, en soumettant l'ensemble du cycle de production à une vérification. La provenance des matériaux recyclés est contrôlée et prouvée, de même que leur dosage et le respect de certaines caractéristiques technologiques et des paramètres définis par la norme ISO14021:2002 de l'Organisation internationale de normalisation et le règlement LEED de l'U.S. Green Building Council (USGBC). Pour plus d'informations : [www.bureauveritas.com](http://www.bureauveritas.com)

Bureau Veritas ist ein Markenzeichen, das die rezyklierte Art des Materials zertifiziert, aus dem ein Produkt besteht und dazu den gesamten Produktionszyklus prüft. Kontrolliert und beurkundet wird die Herkunft der rezyklierten Materialien, deren Dosierung, die Einhaltung einiger technologischer Eigenschaften und das Erreichen der Parameter, die von den Vorschriften ISO14021:2002 der International Organization for Standardization und von den LEED-Vorschriften des U.S. Green Building Council (USGBC) vorgeschrieben werden. Für weitere Infos siehe: [www.bureauveritas.com](http://www.bureauveritas.com)

Bureau Veritas es la marca que certifica la naturaleza reciclada del material con el que está hecho un producto, sometiendo a control todo el ciclo productivo. Se controla y documenta la proveniencia de los materiales reciclados, su dosificación, que se respeten algunas peculiaridades tecnológicas y que se alcancen los parámetros establecidos por la norma ISO14021:2002 de la International Organization for Standardization y del reglamento LEED del U.S. Green Building Council (USGBC). Para más información: [www.bureauveritas.com](http://www.bureauveritas.com)



**GREENGUARD** Certification is the very first voluntary North American indoor air quality product certification created specifically for commercial building products, this certification requires that products meet stringent chemical emissions requirements for over 360 VOCs, plus a limit on the total of all chemical emissions combined. Products undergo routine monitoring and annual retesting to ensure continued compliance with the GREENGUARD Certification standard.



**GREENGUARD GOLD** Certification was developed with the specific health sensitivities of children and other vulnerable health populations in mind and based on key criteria from public health agencies, this certification sets some of the world's most stringent emission limits on over 360 chemicals, a limit on total chemical emissions, and a limit on phthalate emissions. Products undergo routine monitoring and annual retesting to ensure continued compliance with the GREENGUARD Gold standard.

### GREENGUARD / GREENGUARD GOLD

Per ulteriori informazioni e approfondimenti / For further details and information / Pour approfondir et obtenir de plus amples informations

Für weitere Informationen / Para obtener más información

[www.florim.com](http://www.florim.com)



**Marcatura CE / CE Mark / Marquage CE / CE-Kennzeichnung / Marca CE**



Per ulteriori informazioni, approfondimenti e download delle marcature CE: [www.florim.com](http://www.florim.com)

For further details and information and to download the CE marks: [www.florim.com](http://www.florim.com)

Pour obtenir de plus amples informations, approfondir et télécharger les marquages CE: [www.florim.com](http://www.florim.com)

Für weitere Informationen und Downloads der CE-Kennzeichnungen: [www.florim.com](http://www.florim.com)

Para obtener más información y descargar las marcas CE: [www.florim.com](http://www.florim.com)

**Certificazioni di prodotto nazionali / National product certifications / Certifications de produit nationaux  
Nationale Produktzertifizierungen Certificaciones de producto nacionales**



放射性水平 A 类

Certificazione obbligatoria per l'esportazione in Cina  
Certification mandatory for export to China  
Certification obligatoire pour l'exportation en Chine  
Für den Export nach China obligatorische Zertifizierung  
Certificación obligatoria para la exportación a China

Per soddisfare le richieste di norme e regolamenti locali, vi sono anche diverse certificazioni di prodotto nazionali.

Per informazioni in merito contattare [www.florim.com](http://www.florim.com)

To cater for the requirements of local norms and regulations, various national product certifications also exist. For more details contact [www.florim.com](http://www.florim.com)

Pour satisfaire les exigences des normes et réglementations locales, il existe également différentes certifications nationales de produit.

Pour de plus amples informations à ce sujet contacter [www.florim.com](http://www.florim.com)

Darüber hinaus sind auch verschiedene nationale Produktzertifizierungen vorhanden, um die lokalen Anforderungen bezüglich Richtlinien und Reglementen zu erfüllen. Für Informationen dazu wenden Sie sich bitte an [www.florim.com](http://www.florim.com)

Para satisfacer los requisitos previstos por las normas y reglamentos locales, hay también varias certificaciones de producto nacionales. Para obtener más información, contacte con [www.florim.com](http://www.florim.com)

---



**UPEC**

QB-UPEC

Per informazioni relative ai dati tecnici sulla classificazione UPEC vedi il sito [www.florim.com](http://www.florim.com)

Pour toute information concernant les données techniques sur la classification UPEC, nous vous prions de bien vouloir consulter la version française du site [www.florim.com](http://www.florim.com)



**WallPEC**

QB-WallPEC

Per informazioni relative ai dati tecnici sulla classificazione WallPEC vedi il sito [www.florim.com](http://www.florim.com)

Pour toute information concernant les données techniques sur la classification WallPEC, nous vous prions de bien vouloir consulter la version française du site [www.florim.com](http://www.florim.com)



## U.S. GREEN BUILDING COUNCIL

Florim ha aderito volontariamente all'U.S. Green Building Council (USGBC), la più importante associazione statunitense di industrie appartenenti al settore edilizio, unite per promuovere edifici costruiti in accordo a precise disposizioni riguardanti la sostenibilità ambientale che sono incluse all'interno della certificazione LEED (Leadership in Energy and Environmental Design), un sistema a punteggio che misura la sostenibilità di un progetto. L'utilizzo di prodotti Florim contribuisce a ottenere punti per l'acquisizione della certificazione LEED.

Florim has voluntarily become a member of the U.S. Green Building Council (USGBC), the most important American association dedicated to environmentally sustainable building design and construction according to precise directives, which must be followed in order to obtain LEED (Leadership in Energy and Environmental Design) certification, a rating system that measures the sustainability of a project. Using Florim products contributes to getting points to achieve LEED certification.

Florim a adhéré volontairement à l'U.S. Green Building Council (USGBC), la plus grande association américaine d'industries appartenant à la filière BTP, unies pour promouvoir la réalisation de constructions conformes aux dispositions précises édictées en matière de durabilité environnementale, incluses dans la certification LEED (Leadership in Energy and Environmental Design), un système d'attribution de notes mesurant la durabilité d'un projet. L'utilisation des produits Florim contribue à l'obtention de points en vue de la certification LEED.

Florim ist freiwillig dem U.S. Green Building Council (USGBC) beigetreten, dem bedeutendsten Verband der Bauindustrien in den Vereinigten Staaten, die sich zur Förderung von Gebäuden vereinigt haben, die gewissen Nachhaltigkeitsvorschriften entsprechend gebaut werden. Diese Bestimmungen sind in der LEED-Zertifizierung (Leadership in Energy and Environmental Design), einem Punktesystem zur Bewertung der Nachhaltigkeit eines Projekts, enthalten. Der Gebrauch von Florim Produkten trägt zur Erlangung von Punkten der LEED-Zertifizierung bei.

Florim ha adherido voluntariamente al U.S. Green Building Council (USGBC), la más importante asociación estadounidense de industrias pertenecientes al sector de la construcción, unidas para promover la construcción de edificios de acuerdo con precisas disposiciones relativas a la sostenibilidad ambiental, que están incluidas en la certificación LEED (Leadership in Energy and Environmental Design), un sistema por puntos que mide la sostenibilidad de un proyecto. El uso de productos Florim contribuye a obtener puntos para adquirir la certificación LEED.

---

**La certificazione LEED** è una certificazione di edificio non di prodotto. Pertanto i criteri LEED fanno sempre riferimento al sistema edificio e non ai singoli materiali utilizzati nel progetto. La soglia indicata nei crediti si riferisce quindi al parametro cui l'edificio dovrà conformarsi per l'attribuzione del relativo punteggio. Sul sito Florim.com all'interno delle certificazioni di ogni singola collezione, è disponibile la Certification Letters for LEED® Projects.

**LEED certification** is a building certification and not for a product. Therefore, the LEED criteria always refer to the building system and not to the individual building materials used in the project. The threshold indicated in the credits, therefore refers to the parameter to which the building must comply with for the allocation of the corresponding point score. Certification Letters for LEED® Projects are available on the Florim.com website, in the certifications for each single collection.

**La certification LEED** (« Leadership in Energy and Environmental Design ») est une certification qui concerne les bâtiments et non pas les produits. Ainsi, les critères LEED font toujours référence au système bâtiment et non pas aux matériaux utilisés dans le projet. Le seuil indiqué dans les crédits se réfère donc au paramètre auquel le bâtiment devra se conformer pour l'attribution des points correspondants. Sur le site Florim.com, parmi les certifications de chaque collection, la Certification Letters for LEED® Projects est disponible.

**Bei der LEED-Zertifizierung** handelt es sich nicht um ein Produkt- sondern ein Gebäudezertifizierungssystem. Daher beziehen sich die LEED-Kriterien immer auf das Gebäude im Ganzen, nicht auf die einzelnen für das Projekt verwendeten Materialien. Der für die Punkte angegebene Grenzwert bezieht sich daher auf den Wert, den das Gebäude einhalten muss, um die entsprechenden Punkte zu erhalten. Auf der Website Florim.com finden sich in den Zertifizierungen der einzelnen Kollektionen die Certification Letters for LEED® Projects.

**La certificación LEED** es una certificación para el edificio y no para el producto. Por lo tanto los criterios LEED siempre se refieren al sistema edificio y no a cada uno de los materiales utilizados en el proyecto. El umbral indicado en los créditos se refiere por lo tanto al parámetro al cual el edificio se deberá ajustar para que le sea atribuida la correspondiente puntuación. En el sitio web Florim.com, en la sección de las certificaciones de cada colección, están disponibles las Certification Letters for LEED® Projects.



**ENVIRONMENT PRIORITY ONE** / Using nature's resources responsibly

Per sottolineare l'attenzione e l'impegno verso la tutela dell'ambiente, in accordo con la norma ISO 14021 (Environmental labels and declarations) Florim afferma il proprio impegno nella continua innovazione tecnologica dei processi industriali.

To underline our care for the environment and our pledge to protect it in accordance with the ISO 14021 standards (Environmental labels and declarations), Florim affirms its commitment to continual technological innovation of the industrial processes.

Pour prouver l'attention qu'elle consacre depuis toujours à la protection de l'environnement, en accord avec la norme ISO 14021 (Environmental labels and declarations), la société Florim déclare son engagement dans l'innovation technologique continue des processus industriels.

Die Firma Florim möchte ihre Aufmerksamkeit und ihr Engagement zum Schutz der Umwelt gemäß der ISO-Norm 14021 (Environmental labels and declarations) hervorheben und bekräftigt deshalb, dass sie ständig auf technologische Innovation der Industrieprozesse.

Para subrayar la atención y el compromiso adquirido con la tutela del medio ambiente, de acuerdo con la norma ISO 14021 (Environmental labels and declarations) Florim reafirma su dedicación por la continua innovación tecnológica de los procesos industriales.



SGBP 2018-1991

Il Green Building Council di Singapore crea partnership pubblico-privato per promuovere soluzioni di settore innovative attraverso l'intera catena del valore degli edifici e della costruzione. Attraverso i suoi prodotti di bioedilizia e i programmi di etichettatura dei servizi di edilizia ecologica, SGBC stabilisce standard elevati e parametri di riferimento per le soluzioni di bioedilizia sia a livello locale che regionale per aiutare a costruire città più sostenibili per una vita migliore. In qualità di rappresentante di Singapore nel World Green Building Council, SGBC contribuisce attivamente al movimento globale di bioedilizia condividendo competenze e conoscenze durante conferenze ed eventi internazionali.

The Singapore Green Building Council forges public-private partnerships to foster innovative industry solutions across the entire building and construction value chain. Through its green building product and green building services labelling programmes, SGBC sets high standards and benchmarks for green building solutions both locally and regionally to help build more sustainable cities for better living. As Singapore's representative on the World Green Building Council, SGBC actively contributes to the global green building movement by sharing expertise and knowledge during international conferences and events.

---



## ENVIRONMENTAL PRODUCT DECLARATION

L'EPD è una Dichiarazione Ambientale di Prodotto certificata e verificata in modo indipendente, che esprime in modo trasparente e oggettivo le prestazioni ambientali di un prodotto lungo il suo ciclo di vita, in accordo con lo Standard internazionale ISO14025.

L'EPD è basata su specifiche regole che ne definiscono le metodologie di calcolo: le Product Category Rules (PCR), e non prevede soglie prestazioni.

The EPD is a certified and independently verified Environmental Product Declaration that expresses in a transparent and objective manner the environmental performance of a product throughout its life cycle, in accordance with the International Standard ISO14025.

The EPD is based on specific rules that define the calculation methodologies: the Product Category Rules (PCR), and does not provide for performance thresholds.

La DEP est une Déclaration Environnementale de Produit certifiée et vérifiée de façon indépendante, décrivant de manière transparente et objective les performances environnementales d'un produit tout au long de son cycle de vie, conformément à la norme internationale ISO 14025.

La DEP s'appuie sur des règles spécifiques qui définissent ses méthodes de calcul : les Product Category Rules (PCR), et ne prévoit pas de seuils de performance.

EPD ist eine zertifizierte und unabhängig kontrollierte Produkt-Umwelterklärung, die, übereinstimmend mit der internationalen Norm ISO14025, auf transparente und objektive Weise die Umweltleistungen eines Produkts während seines Lebenszyklus bekundet.

EPD basiert auf spezifischen Regeln, die die Berechnungsmethode festlegen: die Product Category Rules (PCR), die keine Leistungsschwellen vorsehen.

La DAP es una declaración ambiental de producto, certificada y verificada de manera independiente, que informa acerca del desempeño ambiental de un producto a lo largo de su ciclo de vida de forma transparente y objetiva, de conformidad con la norma internacional ISO 14025.

La DAP se basa en reglas específicas que definen sus métodos de cálculo, denominadas Reglas de categoría de producto (RCP), y no prevé umbrales de desempeño.



• Il ciclo di produzione delle lastre ceramiche Florim è completato da una cottura ad alta temperatura (fino a 1250 °C a seconda del prodotto); a tali temperature si verificano reazioni chimico-fisiche tra il supporto della lastra e lo smalto superficiale (dove presente) che portano alla formazione di una struttura fortemente compatta, dura e resistente.

• Nelle normali condizioni di utilizzo di lastre ceramiche Florim, qualsiasi fenomeno che riguarda la dispersione di metalli nell'ambiente è assolutamente da escludere; inoltre, anche nelle più estreme condizioni di lavoro, la rimozione di materiale dalla superficie delle lastre come risultato di abrasione è di fatto trascurabile. In ogni caso, qualsiasi tipo di materiale asportato dalle piastrelle è inerte dal punto di vista tossicologico, non ha impatto sull'ambiente e la sua dispersione non comporta alcun effetto.

• Il risultato di studi specifici ha evidenziato che il livello di radioattività naturale in questi materiali non è fonte di potenziali problemi per le persone che vivono in ambienti pavimentati o rivestiti con piastrelle.

• Le lastre ceramiche Florim sono completamente inerti al fuoco (ad esclusione del gres porcellanato decorato). Non rischiano quindi di subire danneggiamenti in caso di esposizione a fiamme libere e non contribuiscono all'intensificazione e propagazione del fuoco. Non rilasciano sostanze tossiche, gas o fumi di alcun tipo e, in caso di incendio, apportano una significativa protezione alle strutture sulle quali sono applicate, riducendo fortemente lo stress termico alle quali sono sottoposte.

• Le lastre ceramiche Florim non costituiscono una base per la proliferazione di batteri e il loro utilizzo è indicato per luoghi in cui le condizioni di sterilità devono essere facilmente mantenute.

• I detriti provenienti dalla demolizione delle lastre ceramiche sono materiali inerti (non reattivi, chimicamente e fisicamente stabili, resistenti all'esposizione prolungata a condizioni estreme dal punto di vista termico, igrometrico e chimico); tali detriti possono essere collocati nell'ambiente senza rischi particolari e trovare impiego anche nella preparazione di sottofondi, ecc.

• Istruzioni per l'installazione: "Nelle operazioni di posa si raccomanda il taglio a umido o il metodo ad incisione e spacco. Evitare di utilizzare utensili per il taglio a secco durante l'installazione. Tecniche di posa improprie possono esporre il posatore a polveri dannose".

• The Florim ceramic slab production cycle is completed by firing at high temperature (up to 1250°C depending on the product); at these temperatures chemical-physical reactions occur between the slab body and the surface glaze (if applied) that result in the formation of a highly compact, hard and resistant structure.

• Under normal conditions of use of the Florim ceramic slabs, any phenomenon of metal dispersion into the environment is absolutely excluded; what is more, even in the most extreme operating conditions, material coming off the slab surface as a result of abrasion is negligible. In any event, any type of material removed from the tiles is inert from a toxicological point of view, has no impact on the environment and its dispersion has no effect at all.

• The results of specific studies have pointed out that the level of natural radioactivity in these materials is not a source of potential risk for persons that live in houses where floor and wall tiles are laid.

• The Florim ceramic slabs (not applicable to decorated gres porcelain) are 100% fire-inert and there is hence no risk of damage in the event of exposure to naked flames and they do not contribute to fire intensification and propagation. They do not release toxic substances, gases or fumes of any kind and, in case of fire, provide considerable protection to the structures on which they are applied, strongly reducing the thermal stress to which they are subjected.

• The Florim ceramic slabs do not constitute a base for proliferation of bacteria and they are suitable for use in places where it must be easy to maintain sterile conditions.

• The debris resulting from ceramic slab demolition is inert (unreactive, chemically and physically stable, resistant to prolonged exposure to extreme conditions from the thermal, hygrometric and chemical point of view) and can be disposed of in the environment without any particular risk, as well as finding use in the preparation of foundations, etc.

• Installation Instructions: "We recommend wet cutting or the score and snap method during the installation process. Do not dry cut using power tools during the installation process. Improper installation techniques could expose installer to harmful dust".

• Le cycle de fabrication des dalles en céramique Florim est complété par une cuisson à température élevée (jusqu'à 1250°C selon le produit). C'est à cette température qu'ont lieu les réactions physico-chimiques entre le tesson de la dalle et l'émail de surface (s'il est appliqué), aboutissant à la formation d'une structure particulièrement compacte, dure et résistante.

• Dans des conditions normales d'utilisation des dalles en céramique Florim, tout phénomène de dispersion des métaux dans l'environnement est absolument exclu. De plus, même dans des conditions extrêmes de travail, le retrait de matière dû à l'abrasion qui se produit à la surface des dalles est parfaitement négligeable. Le type de matière enlevée est inerte du point de vue toxicologique, il n'a pas d'impact sur l'environnement et sa dispersion n'entraîne aucun effet.

• Des études spécifiques ont montré que le niveau de radio-activité naturelle dans ces matériaux ne représentait pas une source de problèmes potentiels pour les personnes vivant dans des pièces dont les sols ou les murs sont recouverts de carreaux céramiques.

• Les dalles céramiques Florim sont totalement inertes au feu (en excluant le grés cérame décoré). Elles ne risquent donc pas de subir de détérioration en cas d'exposition à des flammes nues et ne contribuent ni à l'intensification ni à la propagation de l'incendie. Elles ne dégagent pas de substances toxiques, gaz ou fumées, de quelque type que ce soit, et, en cas d'incendie, elles constituent une protection significative des structures sur lesquelles elles sont appliquées et réduisent considérablement le choc thermique auquel elles sont soumises.

• Les dalles céramiques Florim ne sont pas une base de prolifération des bactéries et leur utilisation est indiquée dans les locaux où le maintien de conditions de stérilité doit être obtenu simplement.

• Les débris provenant de la démolition des dalles céramiques sont des matériaux inertes (non réactifs, chimiquement et physiquement stables, résistant à l'exposition prolongée à des conditions extrêmes du point de vue thermique, hygrométrique et chimique). Ces débris peuvent être déposés dans l'environnement sans risques particuliers et ils peuvent aussi être utilisés pour la préparation de sous-couches etc.

• Instructions d'installation: "Pendant les opérations de pose nous recommandons pour couper le carreau la découpe à l'eau ou la méthode de l'incision sur le carreau. Pendant les opérations de pose ne pas découper à l'aide d'outils électriques. Les techniques d'installation inadéquates pourraient exposer le carreleur à des poussières nuisibles pour la santé".

- Der Produktionsablauf der Florim Keramikplatten wird durch das Brennen bei hoher Temperatur (bis zu 1250 °C je nach Produkt) vervollständigt; bei diesen Temperaturen treten physikochemische Reaktionen zwischen der Unterlegplatte und der (eventuell vorhandenen) oberflächlichen Glasur ein, die zur Bildung einer sehr kompakten, harten und widerstandsfähigen Struktur führen.
- Bei normalen Gebrauchsbedingungen der Florim Keramikplatten ist jegliche Erscheinung hinsichtlich der Feinverteilung von Metallen absolut ausgeschlossen. Auch bei äußerst extremen Arbeitsbedingungen ist der Abrieb der Plattenoberflächen ganz unbedeutend. Jede Art Material, das von den Fliesen abgetragen wird, ist ungiftig und umweltneutral und seine Zerstreuung hat keine Auswirkungen.
- Spezielle Studien haben ergeben, dass der Pegel der natürlichen Radioaktivität dieser Materialien keine Quelle potentieller Gesundheitsstörungen für die Menschen, die in Räumen mit Boden- und Wandbelägen aus Fliesen leben, darstellt.
- Die Florim Keramikplatten sind vollkommen feuerbeständig (ausgenommen das mit Kaltglasur dekorierte Feinsteinzeug). Es besteht also keine Gefahr, dass sie sich, falls sie freien Flammen ausgesetzt werden, beschädigen und sie tragen nicht zur Verstärkung und Ausbreitung des Feuers bei. Sie geben keine giftigen Substanzen, irgendwelche Gase oder Dünste ab und im Falle eines Brandes bieten sie einen erheblichen Schutz der Strukturen, an denen sie angebracht sind, und verringern stark deren Hitzeschock.
- Die Florim Keramikplatten stellen keinen Boden für die Vermehrung von Bakterien dar und ihr Gebrauch ist an allen Stellen angezeigt, wo es erforderlich ist, leicht die Bedingungen der Sterilität aufrechtzuerhalten.
- Der durch den Abbruch der Keramikplatten verursachte Schutt besteht aus trägen (nicht reaktionsfähigen) Materialien, die chemisch und physikalisch stabil sowie widerstandsfähig gegenüber der langen Exposition unter extremen Bedingungen in thermischer, hygrometrischer und chemischer Hinsicht sind. Dieser Schutt kann ohne besondere Risiken im Freien platziert oder auch zur Vorbereitung von Untergründen usw. verwendet werden.
- Installationsanleitung: "Wir empfehlen das Nassschneiden oder schneiden mit Fliesenschneider während des Installationsvorgangs. Während der Installation nicht mit Flex arbeiten. Unsachgemäße Installationstechniken können dem Installateur schädlichen Staub zufügen."

- El ciclo de producción de las losas cerámicas Florim se completa con una cocción a alta temperatura (hasta 1250 °C en función del producto); a dichas temperaturas se verifican reacciones químico-físicas entre el soporte de la losa y el esmalte superficial (si estuviera presente) que llevan a la formación de una estructura fuertemente compacta, dura y resistente.
- En condiciones de uso normales de las losas cerámicas Florim, debe excluirse cualquier fenómeno concerniente a la dispersión de metales en el ambiente; además, incluso en las condiciones de trabajo más extremas, la pérdida de material de la superficie de las losas debido a la abrasión es, de hecho, del todo insignificante. Como quiera que sea, cualquier tipo de material procedente de las losas es inerte desde el punto de vista toxicológico, no tiene ningún impacto en el ambiente y su dispersión no comporta ningún efecto.
- Estudios específicos han demostrado que el nivel de radiactividad natural en estos materiales no es una fuente de potencial peligro para las personas que viven en ambientes pavimentados o revestidos con azulejos.
- Las losas cerámicas Florim son completamente inertes al fuego (excluido el gres porcelánico decorado). Por lo tanto, en caso de exposición a llamas libres no sufren daños y no contribuyen a la intensificación y a la propagación del fuego. Además, no emiten sustancias tóxicas, gases o humos de ningún tipo y, en caso de incendio, aportan una significativa protección a las estructuras en las que están aplicadas y reducen fuertemente el estrés térmico al cual están sometidas.
- Las losas cerámicas Florim no constituyen una base para la proliferación de bacterias, siendo indicadas para aquellos lugares que requieren unas condiciones de esterilidad fáciles de mantener.
- Los residuos procedentes de la demolición de las losas cerámicas son materiales inertes (no reactivos, químicamente y físicamente estables, resistentes a la exposición prolongada a condiciones extremas desde el punto de vista térmico, higrométrico y químico); dichos residuos pueden colocarse en el ambiente sin riesgos especiales y también pueden utilizarse en la preparación de subcapas, etc.
- Instrucciones de instalación: "Se recomienda el corte húmedo o el método de incisión y división durante las operaciones de colocación. Evite usar herramientas de corte en seco durante la instalación. Las técnicas de colocación inadecuadas pueden exponer al instalador a polvo nocivo".

Su richiesta possono essere forniti logotipi personalizzati, grafiche particolari e motivi decorativi ottenuti con taglio ad acqua. Ad ogni richiesta farà seguito il preventivo e saranno comunicati i termini di consegna.

Upon request we can supply personalized logos, patterns and decorated accents obtained by water jet cuttings. For each request, we shall supply an estimate and confirm the delivery time.

Nous pouvons fournir sur demande des logos, et des motifs obtenus par jets d'eau. Pour chaque demande nous faisons suivre une devis délais de livraison.

Auf Wunsch erhalten Sie Dekormotive; personalisierte Firmenlogos, und Sondergrafik mit Wasserstrahlen. Jede Anfrage bekommt einen Kostenvoranschlag sowie, falls eine Bestellung erteilt wird, die vorhandenen Lieferzeiten.

A solicitud, se pueden facilitar logotipos personalizados, dibujos gráficos particulares y motivos decorativos cortados con chorro de agua. Al recibir el pedido, comunicaremos a nuestros clientes el presupuesto junto a los plazos de entrega.



# **CONDIZIONI GENERALI DI VENDITA**

GENERAL CONDITIONS OF SALE  
CONDITIONS GÉNÉRALES DE VENTE  
ALLGEMEINE GESCHÄFTSBEDINGUNGEN  
CONDICIONES GENERALES DE VENTA







## CONDICIONES GENERALES DE VENTA

### 1 NORMATIVA CONTRACTUAL

Salvo modificaciones o derogaciones acordadas por escrito, las presentes condiciones generales disciplinan todos los contratos de venta entre Florim Ceramiche S.p.A. SB y el Comprador sin necesidad de una referencia expresa a ellos. Las variaciones de las condiciones generales de venta, ofertas, bonificaciones o descuentos, acordados por nuestros agentes o por otros intermediarios, solo son válidas previa aceptación escrita de nuestra empresa.

### 2 OBJETO DEL SUMINISTRO

El suministro comprende solamente los materiales, prestaciones y cantidades especificados en nuestra confirmación de pedido. El texto de la confirmación de pedido de Florim Ceramiche S.p.A. SB prevalecerá siempre sobre el texto de cualquier oferta o pedido.

### 3 CONFIRMACIÓN DE PEDIDO

Si la confirmación de pedido de Florim Ceramiche S.p.A. SB difiere de los acuerdos o pedidos en cuanto a los elementos que la componen, el Comprador podrá enviar la correspondiente reclamación por escrito en el plazo de 7 días a partir de la recepción de nuestra confirmación; en caso contrario, esta se considerará aceptada tal como ha sido redactada. Si el lugar de entrega de la mercancía es diferente del indicado en la confirmación de pedido, el cliente se compromete a comunicarlo a Florim Ceramiche S.p.A. SB antes del día previsto para el retiro en la sede de esta última. Dicha comunicación se debe realizar por correo, telefax o correo electrónico, y debe incluir los datos identificativos del destinatario de los bienes y del lugar en el que se debe realizar la entrega. En defecto de esta comunicación, el destino indicado originalmente se considera tácitamente confirmado.

### 4 PRECIOS

Los precios indicados en las listas Florim Ceramiche S.p.A. SB no son vinculantes: en consecuencia, nos reservamos el derecho a modificarlos antes de la aceptación del pedido. Los precios acordados para cada venta son netos, con pago en efectivo y entrega franco fábrica, salvo acuerdo escrito en contrario. Si entre la fecha del pedido (incluso después de la confirmación de la entrega) y la fecha de entrega se verificaran aumentos en los costes de las materias primas, mano de obra, combustibles, gastos de producción, transporte, etc. y en caso de variaciones importantes en los tipos de cambio entre la divisa de facturación y la divisa interna, Florim Ceramiche S.p.A. SB podrá aumentar el precio acordado, comunicándolo por escrito al Comprador (también por telefax o correo electrónico). Si dicho precio supera en un 20 % el acordado en el momento del pedido, el Comprador podrá rescindir el contrato, comunicando su decisión por correo certificado en el plazo perentorio de 10 días a partir de la recepción de la notificación de aumento de precio. En su defecto, el nuevo precio se considerará aceptado.

### 5 ENTREGAS

La venta, salvo acuerdo escrito en sentido contrario, siempre es franco fábrica Florim Ceramiche S.p.A. SB. La mercancía viaja a cargo y riesgo del Comprador. Toda responsabilidad nuestra cesa en el momento de la entrega al transportista, ante el cual, una vez realizados los controles necesarios, el Comprador deberá plantear sus eventuales reclamaciones. Los envíos al exterior, por vía marítima o terrestre, se realizan según las condiciones establecidas en cada caso, indicadas en los "Incoterms" aprobados por la Cámara de Comercio Internacional.

### 6 PLAZOS DE ENTREGA

Los plazos de entrega tienen carácter indicativo; eventuales retrasos de las entregas, interrupciones y suspensiones totales o parciales de los suministros no darán derecho a indemnizaciones o resarcimientos de daños, salvo acuerdo escrito en contrario.

### 7 MUESTRAS

Los datos indicados en los documentos ilustrativos de Florim Ceramiche S.p.A. SB, así como las características de las muestras y modelos enviados por este último al Comprador, tienen carácter indicativo. Estos datos no tienen valor vinculante, excepto en la medida en que hayan sido expresamente mencionados como tales en la oferta o en la aceptación escrita de Florim Ceramiche S.p.A. SB.

### 8 PAGOS

Las facturas de Florim Ceramiche S.p.A. SB pueden ser emitidas el día de suministro, con cadencia quincenal o mensual y su importe neto debe ser pagado en el plazo acordado. Todas las obligaciones de pago entre las partes contrayentes se deben cumplir en la sede de Florim Ceramiche S.p.A. SB. Eventuales pagos efectuados a agentes, representantes o auxiliares de comercio de Florim Ceramiche S.p.A. SB no se considerarán realizados hasta el momento en que las sumas correspondientes sean acreditadas a Florim Ceramiche S.p.A. SB. Salvo acuerdo escrito en contrario, el pago se deberá realizar en el momento de la entrega, en el banco indicado por Florim Ceramiche S.p.A. SB. Cualquier retraso o irregularidad en el pago da a Florim Ceramiche S.p.A. SB derecho a suspender los suministros o a resolver los contratos en curso, incluso si no corresponden a los pagos incumplidos, así como al resarcimiento de los eventuales daños. En todo caso, a partir del vencimiento del pago y sin necesidad de declaración de mora, Florim Ceramiche S.p.A. SB tiene derecho a percibir los intereses de mora en la medida prevista por el decreto legislativo N.º 231 del 09/10/2002. En caso de incumplimiento, incluso parcial, los intereses de mora sobre el importe no pagado se calcularán a partir del día de la entrega, incluso si el plazo de pago había sido acordado en una fecha posterior. Ninguna reclamación o controversia inherente a la calidad de la mercancía, imperfecciones, defectos o cualquier otro aspecto del contrato será eficaz ni podrá ser tomada en consideración, y ninguna acción podrá ser iniciada, hasta el pago integral del precio (cláusula solve et repete). No se admiten compensaciones con eventuales créditos de cualquier naturaleza ante Florim Ceramiche S.p.A. SB.

### 9 GARANTÍAS Y RECLAMACIONES

La calidad del material cerámico se define sobre la base de las normas internacionales aplicables a la clase de producto correspondiente. Florim Ceramiche S.p.A. SB garantiza solo la mercancía de primera calidad. Reclamaciones relativas a mercancía de otras calidades (calidad B, comercial, segunda, tercera, secundaria, existencias, etc.) no serán tomadas en consideración, ni se dará ningún tipo de garantía —implícita o explícita— sobre dicho material. El Comprador tiene la obligación de verificar la calidad y cantidad de la mercancía en breve plazo después de su recepción y, en caso de reclamarlo por escrito, en el plazo de 8 (ocho) días a partir de la recepción, bajo pena de caducidad de cualquier derecho. El material considerado defectuoso deberá ser puesto a disposición de Florim Ceramiche S.p.A. SB para los controles que considere necesarios; cualquier otra acción (restitución, reparación, etc.) deberá ser autorizada previamente por Florim Ceramiche S.p.A. SB en forma escrita. Las reclamaciones y solicitudes de intervención en garantía después de la colocación no serán consideradas en el caso de que el defecto reclamado resulte manifiesto (por ejemplo: desportilladuras, defectos dimensionales, diferencias de tono, etc.). Se señala que la primera calidad puede contener hasta un 5 % de baldosas defectuosas y que el tono del material suministrado puede diferir de la muestra expuesta, dado que la cerámica es intrínsecamente variable en su aspecto. Las reclamaciones por defectos o imperfecciones ocultos deberán ser formalizadas por escrito en el plazo de 8 (ocho) días a partir de su descubrimiento y, en todo caso, en el plazo de un año a partir de la entrega, bajo pena de caducidad de cualquier derecho a garantía y resarcimiento. Además de los datos de facturación, la comunicación deberá contener una precisa descripción del defecto y un presupuesto de los costes de reparación o modificación del producto; en ausencia de estos datos, la reclamación se considerará nula. Si la reclamación resulta infundada, el Comprador deberá resarcir a Florim Ceramiche S.p.A. SB todos los gastos realizados para la verificación (viajes, peritajes, etc.). En todo caso, la obligación de Florim Ceramiche S.p.A. SB se limita a la sustitución de las piezas defectuosas o a la reparación, quedando expresamente excluidas otras indemnizaciones, como - a título indicativo, no limitativo - costes de desplazamiento y relocalización de mobiliario, equipo, maquinaria, etc., lucro cesante debido a la interrupción o suspensión de actividades, molestias, daños indirectos, etc. La presencia de baldosas defectuosas no afecta la calidad del suministro en su conjunto, ni comporta la obligación de su sustitución integral. La duración de la garantía es la establecida por el código civil italiano.

### 10 RESERVA DE DOMINIO

La venta de la mercancía se realiza con cláusula de reserva de dominio; por lo tanto, si los acuerdos contractuales prevén que el pago debe ser realizado - total o parcialmente - después de la entrega, los productos entregados seguirán siendo propiedad de Florim Ceramiche S.p.A. SB hasta el pago integral del precio.

### 11 CESIÓN DEL CONTRATO

El Comprador no puede ceder su posición en el contrato ni en relaciones obligatorias eventualmente derivadas del mismo, sin la aceptación escrita de Florim Ceramiche S.p.A. SB. En tal caso, el Comprador seguirá siendo responsable solidariamente con el cesionario de las obligaciones cedidas.

### 12 PROPIEDAD INDUSTRIAL Y DISTRIBUCIÓN SELECTIVA - LÍMITES DE REVENTA

Florim Ceramiche S.p.A. SB es titular y legítimo poseedor de la exclusividad de las marcas, dibujos y patentes de invención. Con el objetivo de garantizar adecuadamente el respeto de los derechos exclusivos de Florim Ceramiche S.p.A. SB, así como las expectativas de los consumidores finales en cuanto a las características cualitativas previstas, Florim Ceramiche S.p.A. SB controla la distribución de sus productos mediante un sistema de distribución selectiva. Los suministros enviados por Florim Ceramiche S.p.A. SB y por los puntos de venta autorizados están destinados a la instalación por parte del usuario final, no está permitida ninguna forma de reventa a otros intermediarios comerciales diferentes de los usuarios finales, salvo previa autorización escrita de Florim Ceramiche S.p.A. SB. Por lo tanto, la reventa de mercancía que viole esta prohibición se debe considerar no permitida y equiparada a un uso ilícito de los derechos de propiedad industrial e intelectual de Florim Ceramiche S.p.A. SB, con derecho de esta última a solicitar la incautación de la mercancía a cualquier poseedor. Florim Ceramiche S.p.A. SB se reserva el derecho a proceder judicialmente contra todo aquel que esté involucrado en reventas no autorizadas.

### 13 LEY DEL CONTRATO - TRIBUNAL COMPETENTE

El contrato está disciplinado por la ley italiana, incluidos los Usos del Sector de la Provincia de Módena. Para cualquier controversia derivada del contrato de suministro, tanto por parte de Florim Ceramiche S.p.A. SB como por parte del Comprador, tiene competencia exclusiva el Tribunal de Módena. No obstante, es facultad de Florim Ceramiche S.p.A. SB recurrir a foro competidores o diferentes.

### 14 SEGURIDAD DE LA CADENA LOGÍSTICA

Florim Ceramiche S.p.A. SB, con la finalidad de garantizar la seguridad de la cadena logística internacional, les ruega a sus propios CLIENTES el respeto de unos requisitos estándar para garantizar la seguridad de las mercancías objeto de relaciones contractuales y para garantizar su conformidad con la normativa AEO - Operador Económico Autorizado - Aduanas, en toda la Comunidad Europea. Los CLIENTES de Florim Ceramiche S.p.A. SB se comprometen a garantizar que las mercancías recogidas en consigna o consignadas sean expedidas o transportadas, almacenadas, preparadas o cargadas en locales seguros y en zonas de carga y expedición seguras, protegidas contra manumisiones no autorizadas, utilizando solo personal interno autorizado y oportunamente instruido.

**Todos los artículos del presente listín se venden exclusivamente en cajas completas.**

**EL PRESENTE LISTÍN ANULA Y SUSTITUYE LOS LISTINES ANTERIORES.**

**Quanto contenuto nel catalogo è indicativo e non esaustivo riguardo alle grafiche, decori e ai colori riportati.**

Contents of this catalog is indicative and not exhaustive with regard to graphics, decors and colors shown.

Le contenu du catalogue est indicative et non exhaustive en ce qui concerne graphiques, décors et couleurs indiquées.

Die Beschreibungen im Katalog sind indikativ und nicht allumfassend in Bezug auf Grafiken, Dekore und Farben.

El contenido de este catálogo es indicativo y no exhaustivo con respecto a gráficas, decoros y colores ilustrados.







**FLORIM**



**Florim Ceramiche S.p.A. SB**

Via Canaletto, 24 / 41042 Fiorano Modenese (MO) / T. +39 0536 840111 / [florim.com](http://florim.com)